

THIS FILE IS MADE AVAILABLE THROUGH THE DECLASSIFICATION EFFORTS AND RESEARCH OF:

THE BLACK VAULT

THE BLACK VAULT IS THE LARGEST ONLINE FREEDOM OF INFORMATION ACT / GOVERNMENT RECORD CLEARING HOUSE IN THE WORLD. THE RESEARCH EFFORTS HERE ARE RESPONSIBLE FOR THE DECLASSIFICATION OF THOUSANDS OF DOCUMENTS THROUGHOUT THE U.S. GOVERNMENT, AND ALL CAN BE DOWNLOADED BY VISITING:

[HTTP://WWW.BLACKVAULT.COM](http://www.blackvault.com)

YOU ARE ENCOURAGED TO FORWARD THIS DOCUMENT TO YOUR FRIENDS, BUT PLEASE KEEP THIS IDENTIFYING IMAGE AT THE TOP OF THE .PDF SO OTHERS CAN DOWNLOAD MORE!



The National Archives

CONFIDENTIAL

MINISTRY OF DEFENCE

MOD Form 329C
(Revised 1/00)
PPQ = 100

(date of first enclosure)

EC 89

ed

Registered file number

Sec (AS) 12/3

Part No.

G

1. Attention is drawn to the notes on the inside flap.
2. Enter notes of related files on page 2 of this jacket

DIVISION/ESTABLISHMENT/UNIT/BRANCH

Sec (AS) 2a

SUBJECT

UNIDENTIFI(B) FLYING OBJECTS

CORRESPONDENCE

to	Date	Min/ Encl	Referred to	Date	Min/ Encl	Referred to	Date	Min/ Encl	Referred to	Date	Min/ Encl
<p style="font-size: 2em; font-weight: bold;">CLOSED</p> <p style="font-size: 1.5em; font-weight: bold;">RE-COVERED</p> <p style="font-size: 1.5em; font-weight: bold;">22 MAR 07</p>											



RCU001001717

TNT

ONLY

ate

DOWNGRADING

(to be completed when the file goes out of current use)

This file may be downgraded to:

*Restricted

*Unclassified

.....
Certifying Officer

NAME

DATE

ENCL. NO

E. NO. OF

5.12.89

1

11

—

2

17

15.12.89

3

11

19.12.89

4

17

27.12.89

5

17

—

6

12

31.12.89

7

13

11.1.90

8

BA

19.1.90

8/2

19

24.1.90

21

32

2.2.90

22

36

2.90

23.

31

8.2.90

24

33

19.2.90

29

34

21.2.90

29/1

31/1

21.2.90

29/2

(HR) 35
46

7.3.90

37

AMB

DATE

E. NO

E. NO

8.3.90

37/1

43

12.3.90

39

N/A

13.3.90

39/1

46

14.3.90

40

N/A

19.3.90

41

44

15.1.90

34/1

52

—

42/1

47

26.3.90

44/1

50

2.4.90

47

53

31.3.90

46/1

N/A

1.4.90

46/2

N/A

9.4.90

47/2

63

—

47/3

54

17.4.90

48/1

55

—

49/1

64

(26.4.90)

51/1

58

—

60

65

DATE

ENO

E. NO.
REPLY

17.6.90

69

70

19.6.90

72

73

Registered File Disposal Form

MOD Form 202F
(Revised 10/97)

FILE TITLE: (Main Heading - Secondary Heading - Tertiary Heading etc) 'UFOs' - correspondence	Reference: (Prefix and Number): DISSEC(AS) 12/3 Part: G
--	--

PROTECTIVE MARKING (including caveats & descriptors): **confidential**

Date of last enclosure: **10 July 1990** Date closed: **10 July 1990**

PART 1. DISPOSAL SCHEDULE RECOMMENDATION (To be completed when the file is closed)	FOR CS(RM) USE ONLY
Destroy after _____ years <input checked="" type="checkbox"/>	Date of 1st review: 30 NOV 1999
Forward to CS(RM) after _____ years <input type="checkbox"/>	Date of 2nd review: _____
No recommendation <input type="checkbox"/>	Forward Destruction Date: _____
Reviewer's Signature: _____	Reviewer's Signature: _____

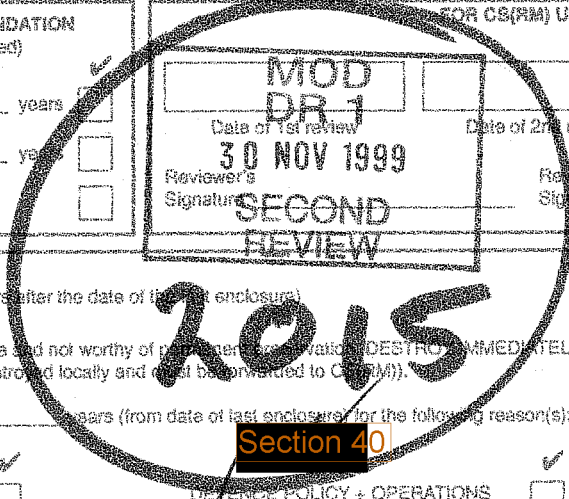

PART 2. BRANCH REVIEW (To be completed not later than 4 years after the date of the last enclosure) (Delete as appropriate)	
a. Of no further administrative value and not worthy of preservation, DESTROY IMMEDIATELY (Remember that TOP SECRET and Codeword material cannot be destroyed locally and must be forwarded to CS(RM)). <input checked="" type="checkbox"/>	
b. (i) To be retained for _____ years (from date of last enclosure) for the following reason(s):	
LEGAL <input checked="" type="checkbox"/>	DEFENCE POLICY + OPERATIONS <input type="checkbox"/>
CONTRACTUAL <input type="checkbox"/>	ORIGINAL COMMITTEE PAPERS <input type="checkbox"/>
FINANCE/AUDIT <input type="checkbox"/>	MAJOR EQUIPMENT PROJECT <input type="checkbox"/>
DIRECTORATE POLICY <input type="checkbox"/>	OTHER (Specify) <input type="checkbox"/>

PPQ = 100

(Continued overleaf)

(ii) Key enclosures which support the recommendation are:

(iii) At the end of the specified retention period the file is to be:

Destroyed

Considered by CS(RM) for permanent preservation

e. Of no further administrative value but worthy of consideration by CS(RM) for permanent preservation.

PART 3. BRANCH REVIEWING OFFICER

Section 40

Signature: _____

Section 40

Name: _____
(Block Capitals)

Grade/Rank: HEO Date: 22/11/99
(Not below HEO/equivalent)

Branch Title and Full Address:

MINISTRY OF DEFENCE
SEC (AS) 2
ROOM 8245
MAIN BUILDING
WHITEHALL
LONDON SW1 2HB

Tel No: Section 40

PART 4 DESTRUCTION CERTIFICATE

It is certified that the specified file has been destroyed.

Signature: _____

Name: _____
(Block Capitals)

Grade/Rank: _____ Date: _____

Witnessed by (TOP SECRET* and SECRET only)

Signature: _____

Name: _____
(Block Capitals)

Grade/Rank: _____ Date: _____

*(FOR CS(RM) USE ONLY)

Section 40

From: Section 40 Secretariat (Air Staff) 2a,



MINISTRY OF DEFENCE Room Section 40

Main Building Whitehall London SW1A 2HB

Telephone: (Direct Dialling) Section 40
(Switchboard)

Section 40

Your reference

Our reference

D/Sec(AS)12/3

Date

10 July 1990

Dear Section 40

Thank you for your letter of 19 June on the subject of Unidentified Flying Objects (UFOs), in which you requested any information we might have on an unusual sighting witnessed most recently on 17 March this year.

As you are already aware, the Ministry of Defence has only a very limited involvement with this subject. I regret that I am unable to offer any definitive explanation for what was witnessed. However, I can confirm that the Ministry of Defence did not receive any reports of unusual sightings around that date.

I am returning the sketch you enclosed with your letter, in case it should prove useful to you.

I hope this is helpful.

Yours sincerely,

Section 40

721

25.6.86 12/3

WEEKLY EXPRESS

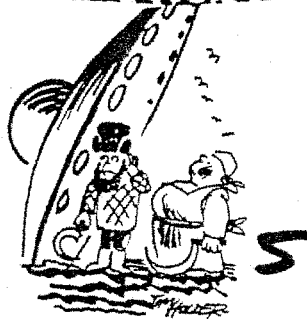

UFO 'shot down by Russians'

From GRAHAM LEES
in Munich

SOVIET fighter planes shot down a giant UFO, and the wreckage was later recovered, it was claimed yesterday.

The close encounter was described by Soviet scientists at an international conference on UFOs in Munich, West Germany.

The scientists said the incident had been kept quiet by the Soviet military authorities, but documents and a picture of the UFO wreckage had recently been leaked.

Two MIG 25 fighters allegedly intercepted the UFO in a remote region of Azarbaijan in 1983. They fired two rockets when it turned on to a collision course.

The pilot's report said the UFO turned a bright colour and fell to earth.

The wreckage was discovered by two mushroom pickers who later died — apparently from exposure to radiation.

Breakdown

ENCLOSURE
72

Section 40

19.6.90.

Dear Section 40

Several reports have emerged over the past 3 years around the Skelmersdale. Of what has to be described as a object that looks like a flying car.

The most recent report that I have ocured on the 17th of march this year. Object was totally black in colour. 4 to 6 blue lights on its under carriage. 2 brilliant white lights on its front. And lastly 2 firey red lights at its tail.

If you can put a name to this craft I would appreciate hearing of it. If not then as ever I thankyou for the time and trouble that I know you will take in answering my enquiry.

Find enclosed sketch made by the most recent reportee of this most unusual object.

yours faithfully

Section 40

Section 40



MINISTRY OF DEFENCE
Sec. (AS) 1
25 JUN 1990

No Reply
Necessary
or possible

Section 40

29/6

Head of Sec (AS)

The attached letter which the Prime Minister has received has been acknowledged by 10 Downing Street and has been forwarded to this Department for official action.

a. No 10 have passed it to us for action as we see fit and you are asked to consider whether there is anything which can usefully be said to the correspondent and to action accordingly.

or

~~b. No 10 have asked that a full reply be sent and you should know that the Prime Minister attaches importance to such replies being sent expeditiously.~~

2. Unless specifically asked to do so, there is no need for you to copy your replies to this office.

Section 40

for APS/Secretary of State

Section 40

27/6/90

I demand to again examination.

12th, June, 1990

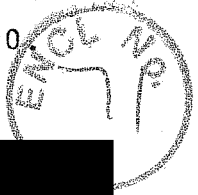

MOD
Misc
UFO.

16/6
regsta
C

Section 40

Seoul

KOREA

Dear Premier Magaret Datcher

I wrote for peoples of your country to very important letters.

My letters include to military secret of Cosmos Supreme Civilization Circle [Infiniteness of the Creation].

I want to know your government. You must without fail keep.

I am all anxiety a nobody know about riskiness of U.F.O. attack to air defense of the earth and electric wave of the for kill and injury.

I want to know to damge due to U.F.O. attack to air defense of the earth and electric wave of the for kill and injury.

I want to discuss about space development of the your country.

I want to meet to you. I demand to mighty support and help.

I demand to emergent a letter of reply (Intelpost Rates).

I wish you success in your future endeavors.

Very truly yours,

P.S. Enclose to Mansion of the Premier(Ireland) send me a letter(copy)

Section 40

A secret envoy of the Cosmos Supreme Civilization Circle
[Infiniteness of the Creation]

A military retaliation necessitate in U.F.O. attack to air defense of the earth [Toward to life physiquies of the red shoes of brown (spacesuit)] and all life physiquies of two fixed star [Fixed star of two light year (A straight distance of the light) and venus] transmitting to electric wave of the for kill and injury.

All women of the fixed star of two light year and venus are as biological robot connive to infringe and something to make a slave [All women include of the fixed stars of two light year and ten fixed star of the solar system].

The Earthians equal Peoples of the Cosmos Supreme Civilization Circle [Infiniteness of the Creation]. Place all Earthians under protection of the Cosmos Supreme Civilization Circle [Infiniteness of the Creation] and Robot's Army.

Specially, place all spacewomen (spacesuit of the Green) under protection of the Cosmos Supreme Civilization Circle [Infiniteness of the Creation] and Robot's Army.

A secret envoy of the Cosmos Supreme Civilization Circle [Infiniteness of the Creation] mightest demand as follows to a military retaliation in U.F.O. attack to air defense of the earth and two fixed star transmitting to electric wave of the for kill and injury.

1. Progress most early to nuclear attack in mother spaceships attack to Earthians's line (solar system).
2. Explode to exit of the venus and fixed star of two light year.

Fixed stars of one light year are VITAL INTEREST of the Cosmos Supreme Civilization Circle [Infiniteness of the Creation].

VITAL INTEREST appoint to IMPORTANT INTEREST and INTEREST INTEREST (In reverse shape).

VITAL INTEREST receive to support of the another civilization circles with IMPORTANT INTEREST and INTEREST INTEREST.

Once more one, my valuable is.....

Fixed star of one light year living my eternal friend Tedro Cria [Lee Koan]. He is a Robocom.

I am protected by Tedro Cria from attack of electric wave of the for kill and injury. I worry to my eternal friend Tedro Cria's personal safety. I demand to help of the Cosmos Supreme Civilization Circle [Infiniteness of the Creation] and Robot's Army.

I want give help to my eternal friend Tedro Cria.

Some time or other, Tedro Cria will grow Earthians's eternal friend.

I eagerly hope Tedro Cria's eternal happiness.

I eagerly hope our deep friendship will last. Forever !

Tedro Cria, Hwayaro Rayaka !

Tedro Cria, you'll live in calm love.

Any time and where.....

The Association Mutual Defense Treaty signatory document of the
Cosmos Supreme Civilization Circle [Infiniteness of the Creation]

First, U.K. is the Association Mutual Defense
Treaty Nation of the Cosmos Supreme Civilization Circle
[Infiniteness of the Creation].

Second, Britishers protect by Cosmos Supreme
Civilization Circle and Robot's Army.

Third, U.K. sign a treaty as follows.

1. A military retaliation necessitate in U.F.O. attack to air defense
of the earth [Toward to life physiquies of the red shoes of brown
(spacesuit)] and all life physiquies of two fixed star [Fixed star
of two light year (A straight distance of the light) and venus]
transmitting to electric wave of the for kill and injury.

2. Follow suitable life physiquies with all life physiquies of the fixed
star of two light year and venus are as criminal of the complicity
in a crime are unavoidable to retaliatory kill and injury.

3. We progress most early to nuclear attack in mother spaceships attack
to Earthians's line (solar system).

4. We explode to exit of the venus and fixed star of two light year.

Section 40



A secret envoy of the Cosmos Supreme Civilization Circle
[Infiniteness of the Creation]

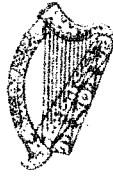

15th May, 1990.

Oifig an Taoisigh
Office of the Taoiseach

Section 40

Dear Section 40

Thank you for your recent letter which will be brought to the attention of the Taoiseach, Mr. Charles J. Haughey, T.D., as soon as possible.

Yours sincerely,

Section 40

Private Secretary
to the Taoiseach.

Oifig an Taoisigh, Tithe an Rialtais, Baile Átha Cliath 2.
Office of the Taoiseach, Government Buildings, Dublin 2.

Section 40

From:

Section 40

Secretariat (Air Staff) 2a



MINISTRY OF DEFENCE Room Section 40

Main Building Whitehall London SW1A 2HB

Telephone: (Direct Dialling) Section 40
(Switchboard)

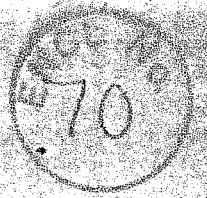

Section 40

BUFORA

Section 40

Your reference

Our reference

D/Sec(AS)12/3

Date

25 June 1990

Dear

Section 40

Thank you for your letter of 17 June, in which you requested any information we might be able to provide on an unusual sighting witnessed on 24 May in Barnes, South West London.

A search of our files has revealed that the Ministry of Defence received a similar report. A copy of this report is enclosed for your information, although in line with our policy to maintain the privacy of the originator, their identifying details have been removed. I regret that because the Ministry of Defence has not investigated the incident, I am unable to offer a definitive explanation for what was witnessed.

I hope this is helpful.

Yours sincerely,

Section 40



WITH COMPLIMENTS

Received through post on 19 June.

Pass on to you to see if
you can help.

answered query already



Aeronautical Information Section (Military)

London Air Traffic Control Centre

Royal Air Force West Drayton

Porters Way

West Drayton

Middx UB7 9AU

Tel: Section 40

17-6-90

Section 40 038

AIS (military) LATCC,
Porters Way,
West Drayton,
Middx., UB7-9AX.

Dear Sir,

Re: enclosed ufo report, referenced above, and submitted for your inspection and comment.

Having investigated this ufo report without succeeding in determining its stimulus, I am writing to you in the hope that, by using your records of flight schedules etc. and comparing these with the characteristics contained in the report, you might be able to shed some light on the nature of the object allegedly seen by the witness.

Following the standard procedure as outlined in the 'Manual of Air Traffic Services' - part 1 I supply you with the information required below:-

REPORT OF UNIDENTIFIED FLYING OBJECT

- A: TIME & DURATION OF SIGHTING Thurs. 24th. May 1990 @ 23.45bst
- B: DESCRIPTION OF OBJECT(S) rectangular, silent, gold, dazzling [of sun] nocturnal object of apparent size larger than a tennis ball held at arms length [no odour]
- C: EXACT POSITION OF OBSERVER(S) outside Section 40 Barnes, London, SW13-OJT & stationary
- D: HOW OBSERVED naked eye
- E: DIRECTION IN WHICH OBJECT(S) WAS FIRST SEEN due north
- F: ANGULAR ELEVATION OF OBJECT(S) 1st seen at 75°, last seen at 15°
- G: DISTANCE OF OBJECT FROM OBSERVER(S) indeterminate
- H: MOVEMENTS OF OBJECT(S) steady motion from due north to due south
- J: METEOROLOGICAL CONDITIONS DURING OBSERVATIONS clear sky and atmosphere - temperature cool - stars visible
- K: The Thames - main flight path to Heathrow

L: Soviet Embassy, Barnes Police, Kew Gardens & Meteorological Office, Bracknell, Daily Mirror & London Evening Standard

M: as per question 'C', tel: Section 40

N: was a former photographer with an interest in astronomy, now retired - has had previous 'fireball' experience in Section 40
Section 40 London, S.E.23

O: none known

P: 21-6-90 by morning post

Any information which you could give me concerning this case, even if in the negative, would be of immense help to me in the course of my enquiries.

Looking forward to your anticipated response.

Yours faithfully,

Section 40

Section 40

Investigator,

Section 40

GROUP		YEAR	NUMBER	INVESTIGATOR	CASE SUMMARY
/INVEST REF:	Section 40	BUFORA REF. 038		Section 40	DATE 24/6/90
				EVALUATOR	TIME 23.45
RETURN FORM TO:-	Section 40	COPY: AIS (MILITARY) LATCC		LOCATION SW BARNES LONDON	
				EVAL'N	
				UFO CLASS	NOCT 05
				CLOSED	

UFO SIGHTING ACCOUNT FORM

SECTION A

Please write an account of your sighting, make a drawing of what you saw and then answer the questions in section B overleaf as fully as possible. Write in **BLOCK CAPITALS** using a ball point pen.

START HERE * I have a 16 year old cat which was a stray. Before he will eat supper he wants to walk round our street even just for 5 mins. which I was doing on 24th May. As I entered my back gate I saw a light in the sky on my left hand side fairly high in sky. At first I thought it was a plane. As it got nearer to me I was struck by the complete silence. It got larger as it neared my house and appeared as drawing. I had to blink several times as it was so dazzling. It gradually got smaller as it went further away and I watched it till I lost sight. I then ran indoors and looked at clocks. Both said 23.45 hours (given a minute or two they were about right. There were no planes or helicopters just this object.

Please continue on a separate sheet if necessary.

DRAWING*

Was dazzling to see shape other than this

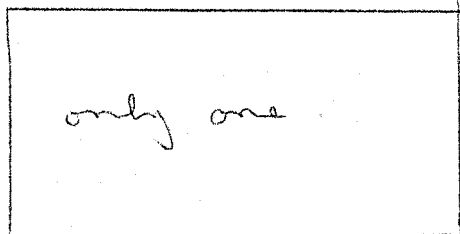

Your full name (Mr/Mrs/Miss/Ms)

Section 40 ... Age Section 40

Address Section 40 BARNES

LONDON S.W.13 Section 40

Telephone No. Section 40 (STD. 0.8.1)

Occupation during last two years

RETIRED

Any professional, technical or academic qualifications or special interests

PHOTOGRAPHER SKY AT NIGHT ON TELEVISION ETC

Do you object to the publication of your name? *Yes/No. *Delete as applicable.

Today's Date 15-6-90

Signature Section 40

* If preferred, use a separate sheet of paper.

GROUP /INVEST REF.		BUFORA REF.	YEAR	NUMBER

SECTION B

Section 40

- Where were you when you saw the object(s)? Exact location Back garden
Nearest town/village Barnes County/District Richmond
- What was the date of your sighting? Thursday day 24th of May 1990
- At what time did you see the object(s)? 23:45 *am/pm/midday/midnight. *Delete which ever does not apply. How did you know the time? looked at two clocks
- For how long did you observe the object(s)? If not certain please state -- for not less than 2 mins and for not more than 5 mins
- If each of the following objects were held at arm's length which one would just cover the object(s) you saw, i.e., have the same apparent size? (underline) Pinhead/pea/halfpenny/penny/ twopence/golf ball/tennis ball/other

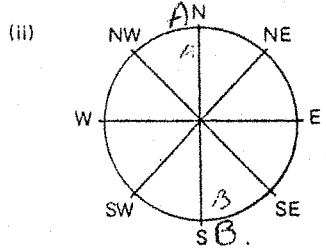
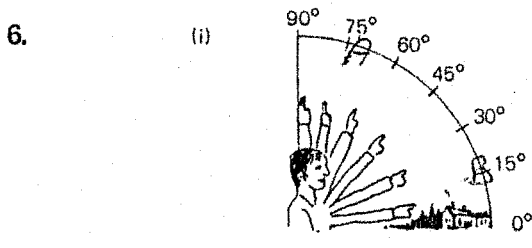

Place an 'A' on the curved line in diagram (i) to show the altitude of the object(s) above the horizon when you first noticed it/them and a 'B' when you last noticed it/them. Also place an 'A' on the outside edge of the compass in diagram (ii) to indicate the direction in which you first observed the object(s) and a 'B' when you last saw it/them.

- Did you see the object(s) at or near ground level? no
- How did the object(s) disappear from view? gradually
- If you took a photograph or made any measurements, give details. no time to get camera
camera not good enough for even photographing moon
- If you noticed any unusual effects on people, animals, plants, objects or equipment nearby: Describe these
Have Helena MW 3.5 E. Cat ignored it altho in my arms at first, then lay at my feet
- What was the main feature of the sighting which made you feel that the object(s) was/were not natural or man-made?
Complete silence, opposite to flight path of planes (Heathrow position)
- How many other people at the same time saw the object(s)? None Give the names, addresses, age and relationship to you of other witnesses

- Give a brief description of the object(s) under the following headings:-
 (a) Number of objects One (b) Colour Gold (c) Sound None
 (d) Shape as drawn was this sharply defined or hazy? hazy?
 (e) Brightness Sun (compared to star, venus, moon, sun etc.)

- What were the local conditions? Please tick in box where applicable.

<u>Clouds</u>	<u>Temperature</u>	<u>Wind</u>	<u>Precipitation</u>	<u>Astronomical</u>
Clear Sky <input checked="" type="checkbox"/>	Cold <input type="checkbox"/>	None <input type="checkbox"/>	Dry <input checked="" type="checkbox"/>	Stars <input checked="" type="checkbox"/>
Scattered cloud <input type="checkbox"/>	Cool <input checked="" type="checkbox"/>	Breeze <input checked="" type="checkbox"/>	Fog or mist <input type="checkbox"/>	Moon <input type="checkbox"/>
Much cloud <input type="checkbox"/>	Warm <input type="checkbox"/>	Moderate <input type="checkbox"/>	Rain <input type="checkbox"/>	Planet <input type="checkbox"/>
Overcast <input type="checkbox"/>	Hot <input type="checkbox"/>	Strong <input type="checkbox"/>	Snow <input type="checkbox"/>	Sun <input type="checkbox"/>

 Other conditions if any just the night for sighting

Section 40

69

17-6-90

Our ref: Section 40 38

Section 40

Secretariat (Air Staff) 2a,
M.O.D.,
Room Section 40
Main Building,
Whitehall,
London,
SW1A-2HB.

Dear Sir,

Re: enclosed ufo report, referenced above, and submitted for your inspection and comment.

Having investigated this UFO report without succeeding in attributing its stimulus to any mundane causes I am writing to you in order that you might be able to shed some light on the nature of the object allegedly observed.

Of course, I do realise that your jurisdiction vis-a-vis the UFO controversy is strictly confined within the parameters of defence and this situation is taken as read. Indeed, contrary to the popular belief, evidence is now beginning to emerge that the UFO question has little, if anything, to do with threats to the airspace of the U.K. Nevertheless, I do need to clarify whether or not there were other reports which were forwarded to the MOD at the time and whether or not you were able to identify the object allegedly seen. Any information you could give me in regard to this case, even if only in the negative, would be of immense help in the course of my enquiries.

Looking forward to your anticipated response.

Yours faithfully,

cf 12/2
e 65

Section 40

Section 40

Investigator,

Section 40

GROUP		YEAR	NUMBER	INVESTIGATOR	CASE SUMMARY
/INVEST REF:	Section 40			Section 40	DATE 24/5/9
RETURN FORM TO:-	Section 40			EVALUATOR	TIME 23.45.1
					LOCATION BARNES SW LONDON
					EVALN
					UFO CLASS NOCT OR
					CLOSED

COPY Section 40 MOD.

UFO SIGHTING ACCOUNT FORM

SECTION A

Please write an account of your sighting, make a drawing of what you saw and then answer the questions in section B overleaf as fully as possible. Write in **BLOCK CAPITALS** using a ball point pen.

START HERE * I have a 16 year old cat which was a stray. Before he will eat supper he wants to walk round our street even just for 5 mins. which I was doing on 24th May. As I entered my back gate I saw a light in the sky on my left hand side fairly high in sky. At first I thought it was a plane. As it got nearer to me I was struck by the complete silence. It got larger as it neared my house and appeared as drawing I had to blink several times as it was so dazzling. It gradually got smaller as it went further away and I watched it till I lost sight. I then ran indoors and looked at clocks both said 23.45 hours (given a minute or two they were about right. There were no planes or Helicopters, just this object.

Please continue on a separate sheet if necessary.

DRAWING*

Was dazzling to see shape other than this

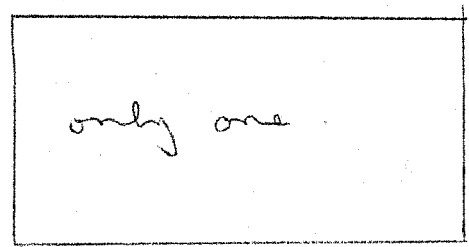

Your full name (Mr/Mrs/Miss/Ms) Section 40 Age Section 40

Address Section 40 BARNES, LONDON S.W.13 Section 40

Telephone No Section 40 (STD. 0.81...)

Occupation during last two years... RETIRED

Any professional, technical or academic qualifications or special interests
PHOTOGRAPHER SKY AT NIGHT ON TELEVISION ETC

Do you object to the publication of your name?
*Yes/No. *Delete as applicable.

Today's Date 15-6-90

Signature Section 40

*If preferred, use a separate sheet of paper.

GROUP /INVEST REF.		BUFORA REF.	YEAR	NUMBER

SECTION B

- Where were you when you saw the object(s)? Exact location Back garden Section 40 Barnes
Nearest town/village Barnes County/District Richmond
- What was the date of your sighting? Thursday day 24th of May 1990
- At what time did you see the object(s)? 23:45 *am/pm/midday/midnight. *Delete which ever does not apply. How did you know the time? looked at two clocks
- For how long did you observe the object(s)? If not certain please state - for not less than 2 mins and for not more than 5 mins
- If each of the following objects were held at arm's length which one would just cover the object(s) you saw, i.e., have the same apparent size? (underline) Pinhead/pea/halfpenny/penny/ twopence/golf ball/tennis ball/other

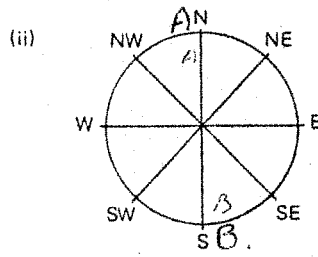
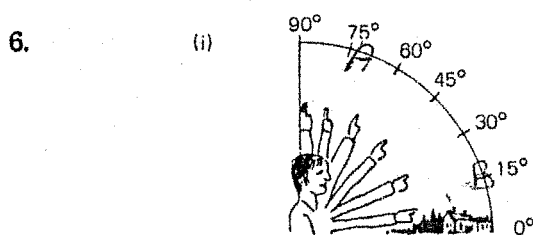

Place an 'A' on the curved line in diagram (i) to show the altitude of the object(s) above the horizon when you first noticed it/them and a 'B' when you last noticed it/them. Also place an 'A' on the outside edge of the compass in diagram (ii) to indicate the direction in which you first observed the object(s) and a 'B' when you last saw it/them.

- Did you see the object(s) at or near ground level? no
- How did the object(s) disappear from view? gradually
- If you took a photograph or made any measurements, give details. no time to get camera
camera not good enough for even photographing moon
- If you noticed any unusual effects on people, animals, plants, objects or equipment nearby: Describe these
Have Helena MW 35E. Cat ignored it altho in my arms at first, then lay at my feet.
- What was the main feature of the sighting which made you feel that the object(s) was/were not natural or man-made?
Complete silence, opposite to flight path of planes (Heathrow position)
- How many other people at the same time saw the object(s)? None Give the names, addresses, age and relationship to you of other witnesses

13. Give a brief description of the object(s) under the following headings:-

- (a) Number of objects One (b) Colour Gold (c) Sound None
(d) Shape as drawn was this sharply defined or hazy? hazy?
(e) Brightness Sun (compared to star, venus, moon, sun etc.)

14. What were the local conditions? Please tick in box where applicable.

Clouds	Temperature	Wind	Precipitation	Astronomical
Clear Sky <input checked="" type="checkbox"/>	Cold <input type="checkbox"/>	None <input checked="" type="checkbox"/>	Dry <input checked="" type="checkbox"/>	Stars <input checked="" type="checkbox"/>
Scattered cloud <input type="checkbox"/>	Cool <input checked="" type="checkbox"/>	Breeze <input type="checkbox"/>	Fog or mist <input type="checkbox"/>	Moon <input type="checkbox"/>
Much cloud <input type="checkbox"/>	Warm <input type="checkbox"/>	Moderate <input type="checkbox"/>	Rain <input type="checkbox"/>	Planet <input type="checkbox"/>
Overcast <input type="checkbox"/>	Hot <input type="checkbox"/>	Strong <input type="checkbox"/>	Snow <input type="checkbox"/>	Sun <input type="checkbox"/>

Other conditions if any just the night for sighting

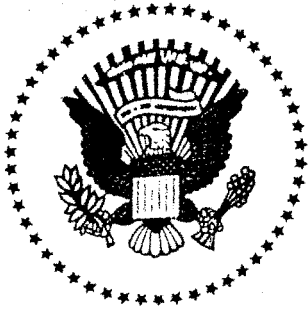

PSI - SECRET - DEPARTMENT
AERONAUTIC-SPACE- and UFO
ADMINISTRATION for Europe

Section 40

PHON : Section 40
Director: [REDACTED]

WEST - GERMANY



CENTRAL PSYCHICAL INTELLIGENCE

DATE: 13. 6.1990

Sehr geehrte Damen und Herren

Unsere Forschungsabteilung arbeitet auch eng mit Ihrer Regierung in London zusammen, da wir nur wenige Informationen von Ufo-Sichtungen aus England gesammelt haben. Bitten wir Sie uns Obskure vorkommnisse (wie einst die Kreise in den Kornfeldern in Südengland) zukommen zu lassen. Wir bitten Sie uns die meisten UFO- Sichtungen der letzten zwei Jahre an uns zu senden.

wir bitten Sie auch uns künftig solche Nachrichten zukommen zu lassen, da wir eine Freie Stiftungs-organisation sind haben wir natürlich keinen telefax oder Fernschreib-Anschluß, deshalb können wir nur Schriftlich erreicht werden.

wir bedanken uns schon im voraus für Ihre mühe uns zu Unterstützen.

mit freundlichen Grüßen

Section 40

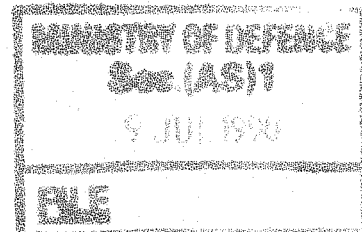

Neue Rätsel und neue verblüffende Antworten zu UFOs und Außerirdischen

Was uns die Geheimdienste verschweigen



Johannes von Buttlar, Wissenschaftler, UFO-Experte und einer der erfolgreichsten Sachbuch-Autoren der Welt

Außerirdische – Phantasie oder Wirklichkeit? Heiß entbrannt darüber ist jetzt wieder die Diskussion, nachdem am 27. September eine rotleuchtende Kugel in der russischen Stadt Woronesch gelandet, ihr ein „Raumfahrer“ mit drei Augen entstieg sein soll. Eine atemberaubende Antwort darauf hat Wissenschaftsautor Johannes von Buttlar:

„Die Regierungen der USA und der Sowjetunion wissen seit langem von der Existenz der Außerirdischen, haben ihr Wissen aber bisher geheimgehalten, um eine Panik zu vermeiden.“ Von Buttlar weiter zu BILDWOCHE: „Jetzt gibt es offenbar eine Absprache der Geheimdienste, durch gezielte Indiskretionen die Menschheit nach und nach darauf vorzubereiten, daß sie nicht allein im Universum ist.“

Tatsächlich häufen sich in letzter Zeit Berichte über „Begegnungen der dritten Art“: ● Vor der Landung des Woronesch-UFOs beobachteten Bürger in der UdSSR an verschiedenen Orten gleichfalls rotleuchtende Kugelraumschiffe. ● Am 7. Mai schossen südafrikanische Abfangjäger ein

UFO über der Kalahari ab. Die zwei Insassen – menschenähnliche Wesen mit drei Zehen und Fingern mit Schwimmhäuten – wurden gefangengenommen und jetzt auf dem US-Luftwaffenstützpunkt Dayton (Ohio) vernommen. So zitiert Tony Dodd, ehemaliger Luftwaffenangehöriger, aus US-Geheimquellen. ● Am 15. März meldete die Besatzung der US-Raumfähre Discovery der Bodenstation in Houston, daß sie auf ihrem Flug von einem fremden Raumschiff begleitet wurde. ● Kurz darauf enthüllte UFO-Forscher Clifford Stone Geheimpapiere der US-Regierung. Demnach hatten sich Experten der US-Luftwaffe mit Außerirdischen auf der Erde getroffen und testeten ihre Raumschiffe.

„Ich nehme einige von inzwischen vielen tausend beobachteter Vorfälle sehr ernst“, sagt von Buttlar. Skeptischer ist Astronom Dr. Erich Übelacker

(Hamburg): „Bei 2000 UFO-Erscheinungen konnten wir eine natürliche Erklärung finden oder UFOs als Schwindel entlarven. Dennoch ist ihre Existenz nicht ganz auszuschließen.“



Abgeschossene UFO-Besatzung: So sollen die Wesen aussehen, die in USA verhört werden

Inzwischen fragen sich angeesehene Wissenschaftler auf der ganzen Welt, woher die technisch übermächtigen Wesen kommen könnten. Der Zeit-Forscher Ernst Meckelburg z. B. meint, daß es unsere Nachfahren sind, die uns mit Zeitmaschinen aus der Zukunft besuchen.

Möglich auch, daß Außerirdische in Raumschiffen mit uns unbekanntem Super-Triebwerken aus unentdeckten Sonnensystemen kommen. Entstanden sind die Übermenschen, so britische Forscher, wie wir: aus Genen, der kleinsten Substanz unserer Erbfaktoren. Im Weltall wimmelt es von diesen winzigen Bausteinen menschlichen Lebens. Eine andere These besagt, daß die E.T.'s Überlebende des erdähnlichen Planeten „Phaeton“ aus unserem Sonnensystem sind. Er zerplatzte einst – als Folge einer Atomkatastrophe?

Was sollten die fremden Planetarier bei uns wollen? Johannes von Buttlar meint: „Vielleicht wollen sie durch ihre Aufklärungssonden Zeichen setzen, damit wir uns der Verantwortung für unsere Erde bewußter werden.“

Hans-Jörg Schütt

Außerirdische sind in Amerika gelandet: Szene aus dem Film „Der Tag, an dem die Erde stillstand“

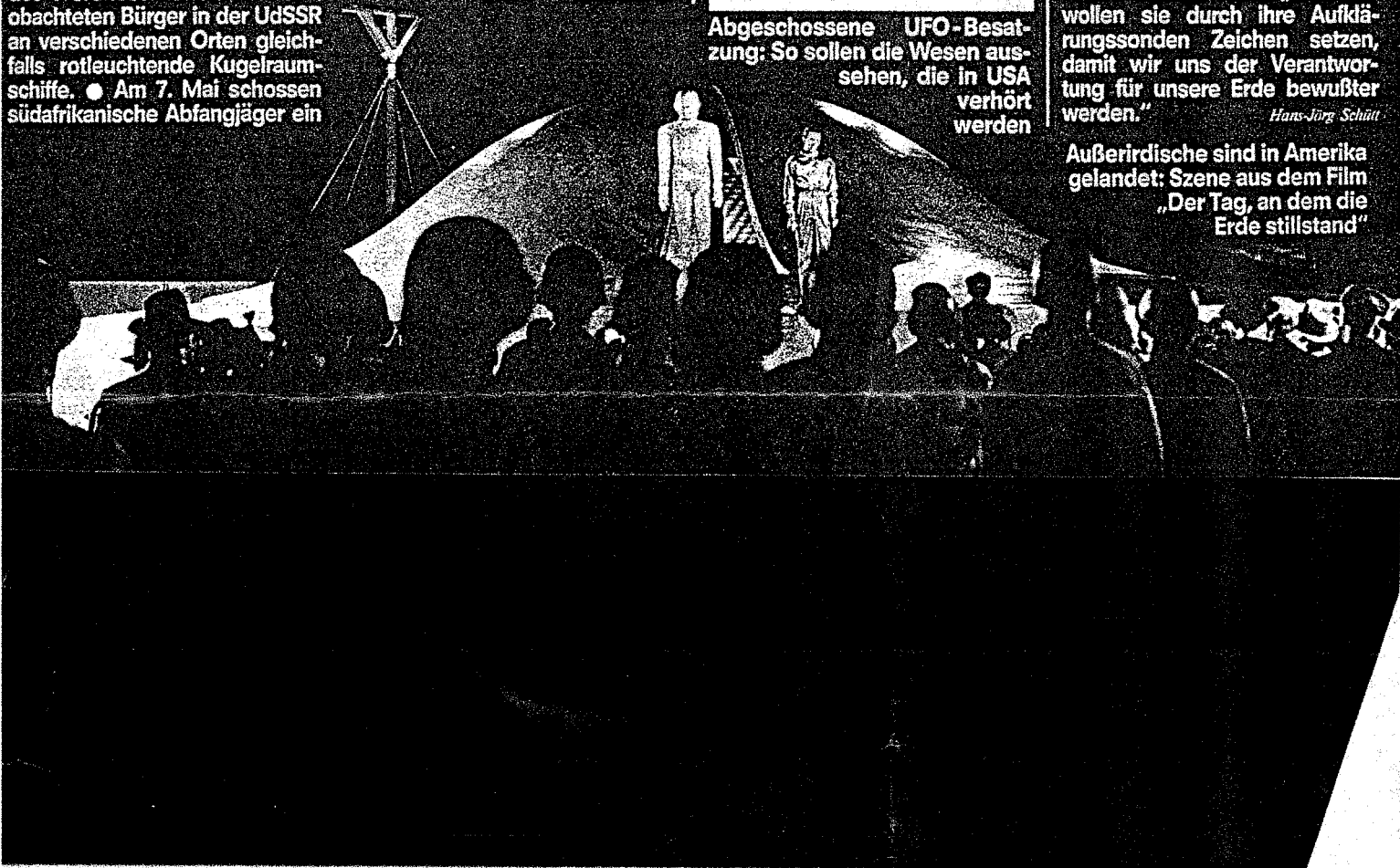



Karl F. Kohlenberg

Wer ist Karl F. Kohlenberg? - Erstmals wird hier diese Frage voll beantwortet und seine Entwicklung dargestellt: Schiffsjunge, Internatschüler, Landwirtschaftseleve bei Schwerin, Weltenbummler, Soldat, Buchhändler, Journalist, Sportsegler, Redakteur, Ethnologe - und dazu noch Schriftsteller! 77 Titel enthält das Register seiner Werke, einschließlich einiger Übersetzungen aus seiner Feder, aber ohne Übersetzungen in andere Sprachen und ohne die zahlreichen Neuauflagen.

Karl F. Kohlenberg schrieb Bücher und Erzählungen für die Jugend, Führer für Sportsegler und Romane, Entdeckungs- und Abenteuergeschichten, Ethnologisches und Futurologisches. Bestseller war sein Buch "Enträtselte Vorzeit", das 1970 für die "ungelösten Rätsel der Vergangenheit" Erich Dänikens eigene Lösung anbot. Mit seinem 1981 erschienenen Roman "Apokalypse; Report einer Zukunft" hat er aus seiner "Enträtselten Zukunft" von 1972 in spannender Form aufrüttelnde Konsequenzen entwickelt. Ob es um Ostindische Geheimnisse oder um Forschungs Expeditionen geht, um Vergangenheit oder Zukunft: Kohlenberg weiß zu gestalten und Leser zu gewinnen. "Kennzeichnend für das Gewicht seines Schaffens ist eine gewisse Einheitlichkeit der Grundausrichtung, des Auftrages, dem er sich verpflichtet weiß, in der Treue zu sich selbst, dazu innerliche Wahrhaftigkeit trotz notwendiger Phantasie sowie ein Ahnungsvermögen innerer Zusammenhänge, die in Worte und ansprechende Darstellung einzubringen eben die ureigene Aufgabe des Schriftstellers, des Meisters ist." Das ist die abschließende Beurteilung seines Biographen (S. 56).

Dr. Heinz Martin Werhahn, selbst erfahrener Autor, ist als ehemaliger Bibliotheksdirektor der Stadt Aachen (1965 - 78) mit Kohlenbergs Büchern sozusagen von Amts wegen vertraut und beleuchtet sie im Spiegel der Kritik. Nur in einem Zusammenhang, wie er hier erstmals deutlich wird, läßt sich der "rote Faden" erkennen, der sich durch Kohlenbergs Werk hinzieht und es als literarisch bedeutsam ausweist.

H. M. Werhahn: Karl F. Kohlenberg - Leben, Werk, Wirkung.

Verlag CITY-PRINT GmbH, Aachen (1982) ISBN 3-88817-000-1. 61 S. kart. 9,80 DM. (Gedruckt mit Unterstützung des Kultusministers des Landes Nordrhein-Westfalen)

Section 40

Section 40

Section 40

Sehr geehrter

den 1. März 1990

es hat ein wenig länger gedauert mit meiner Antwort auf Ihren Brief vom 18. Februar d.J., weil dieser über den Verlauf ging und ich z. Zt. tief in der Arbeit an einem neuen Roman stecke.

Dennoch erscheint mir die UFO Angelegenheit wichtig genug, um ihr alle Aufmerksamkeit zu widmen. Ich selbst habe die Dinger aus nächster Nähe gesehen. Vorausschicken muß ich: Im Krieg war ich Flak-Offizier und dann Aufklärungsflieger für das Oberkommando der Luftwaffe Südost, General Felmy, also erstens bestens mit der Fliegerei vertraut und an genauestens Beobachten gewöhnt.

Alsö zwei UFOs kamen an der niederl. Deutschen Grenze herunter, umflogen Aachen und bei Lichtenbusch über die Belgische Grenze genau über meine Wiese, dann nach Eynatten, Kelmis, Eupen zur Gileppe Talsperre, wo sie verweilten und danach verschwanden.

Von meinem Standort 1 km entfernt, 100 m hoch, dreieckig, Größe etwa 50 x 70 m, konnten sie auf der Stelle verhalten, blitzschnell nach jeder Richtung ausbrechen wie Fische im Aquarium. Sie strahlten ein neonartiges gleißendes Licht durch kompakte Rumpfwände aus. Piloten nicht zu erkennen. An jeder Ecke ein rotes Licht, unter dem Rumpf ein oranges. Die roten Lichter dienten zugleich auch als überaus grelle Scheinwerfer, die auf für sie interessante Objekte gerichtet wurden. Kein Fahrgestell, keine Leitflossen, keine Fenster.

So etwas gibt es z.Zt. auf der Erde nicht. Ich hatte 10 min. Zeit, mir alles einzuprägen. Sie flogen nicht, sonder schwammen in einer Art eigenem Magnetfeld. Physiker von der Th Aachen sagten mir, das gibt es bei uns nur im Labor. Tausende haben die Dinger gesehen. Leute gerieten in Panik. Der Gendarm, der sie im Einsatzwagen auf der Autobahn verfolgte, erzählte mir, sie hätten über einem abgestellten Großbagger verweilt und ihn angestrahlt, ebenso den Turm der Talsperre in Flutlicht getaucht. Feuerwehr und Polizei rückten aus, ebenso wurde ein Abfangjäger eingesetzt; sie kamen aber alle zu spät.

Offenbar sind diese UFO Leute friedlich, nur neugierig. Es gibt verschiedenes, das mich seltsam berührt. Erstens, warum nur ein Abfangjäger, da in Nörvenich eine ganze Staffe startbereit steht. Zum andern das Verhalten der Presse. Gut, die Journalisten sind keine Flieger. Sie müssen sich auf die Aussagen der über tausend Augenzeugen verlassen. Weiter: Warum tun die befaßten Regierungen nichts? Und last not least, hatte denn niemand von den vielen Beobachtern eine Kamera zur Hand?

Kein Motorengeräusch, nur leises Summen.

Inzwischen sind wieder - nur bei klarem Wetter, aber sehr niedrig, ca 200 m - solche Apparate gesichtet worden; man spricht von 10 bis 20, und zwar im Raum Eupen-Hohes Venn. Nun glaube ich fast an eine Landungsaktion. Ich war im Kriege auch mit der Planung von Luftlandeplänen befaßt und ich würde mir für einen Großeinsatz genau diesen Raum aus-

gesucht haben. Dünn bevölkert. Ausfallstraßen nach allen Richtungen, aber leicht abzusperren. Ballungsgebiete und Großhäfen in nächster Nähe. Schätze, es würde mindestens drei Tage kosten, ehe die Regierungen in Aktion treten können, wahrscheinlich länger. Vom Radar werden sie nur streckenweise erfaßt.

Da Ähnliches in Rußland und USA geschieht, drängt sich der Gedanke an die Parusie-Überlieferungen auf, die ja die Wiederkunft der "Götter" für unsere Zeit vorausgesagt haben. s.a. mein Vorzeit-Buch.

Angesichts dieser Vorführung sollte man auf alles gefaßt sein. Wenn ich dergleichen vor Normalbürgern äußere, sehe ich stets das mitleidig skeptische dämliche Grinsen. Eine Entsprechung erlebte ich als Geheimdienstler im Lw.Oberkommando, als ich vor dem englischen Radar warnte. Es scheint, daß der Normalbürger nur durch Schaden klug wird. Der Gendarm sagte mir, was soll ich tun, wenn sie tatsächlich landen? Da muß ich doch einschreiten. Ich riet ihm, das Einschreiten zu unterlassen, denn Leute, die dergleichen zustande bringen, sind jedem Düsenjäger haushoch überlegen und ganz gewiß seinem Ballermann. Mein Nachbar, ein Bauer, holte seine Schrotflinte aus dem Schrank. Mir scheint das nicht die richtige Art, mit diesem Phänomen umzugehen. Auch hier wäre Aufklärung durch die Regierungen notwendig. Zum Schluß noch: Da die Regierungen offenbar besser darüber unterrichtet sind als die Öffentlichkeit, könnte nicht die immerhin plötzliche und, bedenkt man es recht, nicht sehr plausible politische Kehrtwendung des Ostens darauf zurückzuführen sein?

Was nun Atlantis betrifft, liegen Sie scheinbar ein wenig zurück. Man hat ja bei den Bermudas erstaunliche Relikte unter Wasser entdeckt. Trotzdem spekulieren Massenmedien immer noch rund um Kreta und Santorin. Beides mir wohlbekannt. Aber die Beschreibungen über Atlantis sprechen von einem großen Kontinent mit sieben großen Inseln. Auf den Scillies sind die Einwohner fest überzeugt, daß sie zu den Nachfahren der Atlantier gehören, die Scillies der Rest des sagenhaften Landes Lyoneß ist. Die Basken übrigens auch. Sie haben ganz recht, die meisten "Wissenschaftler" sind uralte, hoffnungslos out of date, schreiben einer vom anderen ab, daher nicht lernfähig.

Natürlich bringen ungeklärte Fakten eine Menge unsinniger Spekulationen hervor. Siehe anliegenden Artikel vom Ufologenkongreß. Obwohl ich selbst über einige mediale Fähigkeiten verfüge, stehe ich Äußerungen darüber doch mit Skepsis gegenüber. Viel Quatsch cum grano salis. Andererseits halte ich für ausgesprochen dumm, etwas, das man nicht kennt, glatt abzulehnen. Ich glaube also, daß Atlantis genau an der Stelle liegt, wo Plato es angesiedelt hat wie ich ja auch im Vorzeitbuch zu dokumentieren versucht habe. Aber ich sehe im Augenblick keine Möglichkeit, der Sache mit wissenschaftlicher Akribie auf den Grund zu gehen. Das würde eine Lebensarbeit bedeuten. Und ich bin mit meinen historischen Forschungen und Romanen vollkommen ausgelastet. Würde mich aber freuen, von Ihnen über den Fortgang Ihrer Absichten zu hören und bin gern bereit, auf Fragen, die in mein Wissensgebiet fallen, zu antworten.

Warum sind die Vorzeitüberlieferungen der Basken noch nicht übersetzt?

Mit freundlichen Grüßen

Ihr

Section 40

Im ganzen Grenzland rätselt man über ein leuchtendes Flugobjekt

Belgien, die Niederlande und Deutschland leiden unter „Ufo-Fieber“

VON MANFRED KISTERMANN
UND WILLY TIMMERMANN

Aachen/Eupen. - Das Grenzland leidet unter einem „Ufo-Fieber“. Am späten Mittwochabend riefen unabhängig voneinander besorgte Bürger bei den Sicherheitsbehörden in Belgien und Deutschland an. Alle wollten ein Flugobjekt mit starken Scheinwerfern gesehen haben. Zahlreiche belgische Gendarmereibeamte sahen zwischen 17.30 und 20.30 Uhr über Kettenis-Eupen das Ufo (unbekanntes Flugobjekt), aus Richtung Lichtenbusch kommend anfliegen. Ein Gendarm berichtete: „Über dem Ketteniser Busch stand eine weißglänzende Scheibe mit drei sehr hellen Scheinwerfern und einem Rotlicht und verursachte lediglich ein gleichmäßiges Rauschen. Nach einiger Zeit flog es sehr schnell weiter in Richtung Gileppe-Talsperre. Dort strahlte das deltaförmige Objekt den Aussichtsturm mit seinen Scheinwerfern an und benutzte eine Art „Laser-Pistole“ zum Anstrahlen der Umgebung. Fast eine Stunde blieb es dort „stehen“, bevor es sich in Richtung Spa ent-

fernte. Eine Anwohnerin der Eupener Hochstraße, die Rundfunk und Polizei benachrichtigt hatte, gab an, sie sei beim Anblick dieses eigenartigen Flugobjektes am Abendhimmel derart erschrocken gewesen, daß sie mit ihrem Wagen fast gegen einen Baum gefahren sei.

Anderen Beobachtern im Raum Eupen und Verviers zufolge sei ein zweites unbekanntes Flugobjekt mit hoher Geschwindigkeit von der Autobahn Aachen-Lüttich in Richtung der Gileppe-Talsperre geflogen.

Bei Nachfragen der Gendarmerie am Flughafen Lüttich-Bierset kam die Auskunft, daß auf dem Radarschirm ein eigenartiger Flecken gesichtet worden sei, der jedoch infolge der geringen Flughöhe nicht genau ausgemacht werden konnte. Lüttich alarmierte daraufhin die Awacs-Leitstelle in Geilenkirchen, die eine Maschine zur Beobachtung in den Eupener Raum sandte. Die Himmelswächter konnten aber auch nichts mehr feststellen.

Anwohner in Verviers, Andrimont, Jalhay, ja sogar in Huy, südlich von Lüttich, hatten das gleiche Phänomen beobachtet. Der

Präsident der belgischen Vereinigung für Raumphänomene mit Sitz in Brüssel gab an, daß seit nunmehr 18 Jahren die Vereinigung 700 Aktenstücke über derartige Vorkommnisse, für die es keine logische Erklärung gebe, angelegt habe.

Im Raum Aachen war die Polizei ebenfalls alarmiert. Streifenwagen wurden ausgeschickt, um im Stadtteil Forst Ausschau zu halten.

Auch in Richtung Eifel wurden Polizisten in Marsch gesetzt. Allerdings konnten die Beamten nur die Flutlichtmasten eines Sportplatzes ausfindig machen und einen Großbagger mit starken Scheinwerfern entdecken.

Aus den Niederlanden waren bereits am Dienstag entsprechende Hinweise auf ein Flugobjekt, das mit starken Scheinwerfern die Grenze zur Bundesrepublik entlangflog, eingegangen. Eine Identifizierung war aber auch dort nicht möglich.

Eine Nachfrage unserer Zeitung beim Bundesgrenzschutz ergab, daß es in den letzten Tagen keinerlei Hubschraubereinsätze entlang der Grenze im Aachener Gebiet gegeben habe.

Keine Laserstrahlen

Eupen. - Bei den „Ufos“ über Eupen und Gileppe habe es sich nicht um Laserstrahlen einer Diskothek gehandelt, wie dies im 100 Kilometer entfernten limburgischen Ort Halen am Wochenende der Fall war, bestätigten mehrere Zeugen, die vor etwa zwei Wochen eigenartige Phänomene am Abendhimmel wahrgenommen hatten. Der Diskothekenbesitzer in Halen (Ortschaft zwischen Hasselt und Diest) hatte die Laserstrahlampe für 80 000 BF (rund 4000 Mark) von einer Brüsseler Firma gemietet und am Samstag erstmals ausprobiert. Als plötzlich am Abendhimmel elipsenförmige bunte Kreise wahrgenommen wurden, gingen innerhalb weniger Minuten Hunderte von Anrufen bei Polizei und Gendarmerie ein. In Verviers wird am Donnerstag, 21. Dezember, im Kulturzentrum, Place du Marchee, während eines Vortrags über Bio-Kosmologie ein Film gezeigt, der am 2. und 3. Dezember vom höchsten Punkt Belgiens, vom Botrange-Turm aus gedreht wurde und Aufschluß über Ufos

oder damit zusammenhängende Himmelserscheinungen geben soll.

Die Armee geht auf „Jagd“ nach Ufos

Eupen. - Über hundert Personen aus Eupen und auch der belgischen Eifelorte haben in den letzten Tagen und Monaten die eigenartigen Erscheinungen von „Ufos“ (Unbekannte Flugobjekte) beobachtet und der Gendarmerie sowie dem belgischen und französischen Zentrum zum Studium von Phänomenen des Alls Einzelheiten geschildert. Inzwischen haben sich Brüsseler Innen- und Landesverteidigungsministerium in die Untersuchungen eingeschaltet. Geklärt werden soll auch, ob es sich bei den „Erscheinungen“ um atmosphärische Störungen handeln könnte.

US-Botschaft in Brüssel formell

UFOs keine F-117 A

Brüssel (belga). — Nach den Presseberichten, in denen die amerikanischen Flugzeuge F-117 A als die möglichen UFOs über Belgien vorgestellt worden waren, hat die Botschaft der USA in Brüssel jetzt eine Meldung verbreitet, die diese Schlußfolgerungen als unrichtig wertet.

Das Grenz-Echo hatte in seiner Montagausgabe von der „vielleicht plausibelsten Erklärung“ für die noch nicht identifizierten Flüge gesprochen. Die US-Botschaft betont jetzt, keine F-117 A habe belgisches Gebiet überflogen. Sie habe entsprechende Informationen aus dem Hauptquartier der US Air Force in Washington eingeholt.

Das Hauptquartier der US-Streitkräfte für Europa in Ram-

stein reagierte allerdings zurückhaltender auf entsprechende Fragen der Belga-Agentur in Brüssel. Ein Sprecher in Ramstein verweigerte jegliche Auskunft über mögliche Einsätze dieses Flugzeuges über Europa. „Wir verfügen nicht über ein Flugzeug dieses Typs“, hieß es dort lediglich. Alle weiteren Fragen müßten an das Pentagon in Washington gerichtet werden.

Brüssel glaubt nicht daran

Daß das streng geheime amerikanische Flugzeug F-117 A über Ostbelgien den Eindruck von UFOs erweckt haben könnte, glaubt man bei den Luftstreitkräften in Brüssel und beim dortigen Verteidigungsministerium nicht. Generalleutnant Terrasson betonte,

die USA könnten schließlich das Überfliegen belgischen Gebietes nicht ohne die vorherige Genehmigung durch die höchsten militärischen Dienststellen anordnen.

Sachverständige beim Militär glauben zudem, die bekannten Eigenschaften des Flugzeugs F-117 A stimmten in wesentlichen Dingen nicht mit den vorliegenden Zeugnisaussagen überein. Dieses Flugzeug werde zwar kaum vom Radar erfaßt, sei jedoch sehr laut und könne von den Abmessungen her nicht als das UFO in Frage kommen.

Übrigens kostet ein Exemplar dieser lange Zeit geheimen US-Flugzeuge mehr als 100 Millionen Dollar (3,5 Milliarden F).

Ufos: Kaum Neues Grenz Echo

7. Dez. 89

Seit zwei Tagen keine Meldungen

Eupen. — Seit sich der Himmel über Ostbelgien bewölkt hat, sind offensichtlich keine neuen Ufos gesichtet worden. In der Grenz-Echo-Redaktion gingen zumindest gestern keine weiteren Meldungen über unbekannte Flugobjekte ein.

Wenn die Lage am ostbelgischen Himmel sich auch beruhigt hat, ist die Gesellschaft für das Studium von Phänomenen des Alls (Sobeps) in Brüssel nicht untätig geblieben. Gestern vormittag trafen Vertreter der Gesellschaft mit Beamten des Wissenschaftsministeriums zusammen, denen sie den Vorschlag unterbreiteten, daß Gendarmeriebeamte oder Polizisten, die Ufos beobachten oder denen solche Beobachtungen gemeldet werden, sich unverzüglich mit der So-

beps in Verbindung setzen sollen.

Gestern abend fand zudem am Sitz der Sobeps in Brüssel eine Informationsversammlung statt, zur Vorbereitung intensiver Augenzeugenbefragungen, die am Wochenende in Ostbelgien durchgeführt werden sollen. In Rahmen dieser Befragungen wird der aus Ostbelgien stammende Neu-Löwener Professor für Physik, August Meessen, nach Eupen kommen, um sich an den Recherchen zu beteiligen. Voraussichtlich wird die Sobeps am Samstag und Sonntag in den Räumen des Grenz-Echos anwesend sein, wo Augenzeugen die Sachverständigen aufsuchen können.

Zur Erinnerung nochmals die Telefonnummer der Sobeps: 02/523-60 13

können.

Ufo-Untersuchungen

Eupen. — Anlässlich einer Pressekonferenz in Brüssel wurden weitere Einzelheiten über die rätselhaften „Unbekannten Flugobjekte“ (Ufos) Ende November über Ostbelgien bekannt. Aus konkreten Schilderungen geht hervor, daß es sich bei den Flugkörpern einmal um deltaförmige Gebilde, andererseits um schalenförmige Körper handelte, wie sie teils von Science-Fiction-Filmen her bekannt sind. Die gesichteten Lichtquellen gingen von den Ufos selbst, nicht von der Erde aus.

Die Weser retten

Section 40

[redacted] phoned 11/6

(11)

Reports of 2 UFOs - 1st on Sat 5 May
 4.45 am - Enormous Disc about size of
 3 terrace houses - dome on top blue
 metallic colour reddish electrical light
 and two powerful spotlights.

2nd - Mendips Hill radio mast Boundary
 area of Bristol.

Section 40

[redacted] + about 10 of his cronies went up
 on 7th June saw one object which
 then multiplied into 7 objects which
 were recorded on video.

Section 40

[redacted] to send us a black and white
 photo of a UFO taken in Birmingham
 - I promised we would take a look
 and give our opinion.

Section 40

[redacted] 11/6

MEMORANDUM

MOD Form 4A

To APS/US & S(AF)
 Room Section 40
 Main Building

From Sec(AS)2a
 Room Section 40
 Main Building

Date 11 June 1990

Tel. Section 40 MB

Your ref. ADG/OA/100/3431

Our ref. D/Sec(AS)12/3

Subject 'UFO' REPORT

1. A report of a suspected meteorite was sent to US of S(AF)'s office, from whence it was forwarded to Sec(AS) for answer.
2. Having looked at the report, it is clear that no answer has been requested by the witness. This being so, Sec(AS) will be taking no further action on this matter.

Rank/ Appointment

EO

Name in Block Letters

Section 40

Signature

Section 40

ENC 66

OFFICAL ACTION RECALL LIST

.....Sec(A5).....

Reference ADG/OA/100/.....3431.....was passed to your branch
for Offical Action on.....27th April 1990..... for answer by
Close Of Play 11th May 1990.....

As yet we have not seen a copy of your reply and would
be grateful to recieve one as soon as possible. Alternatively
should the correspondence have been transfered to another branch,
perhaps you could inform this office of the details.

I enclose a copy of the letter in case you need to re-do
the action on this case.

Name of Correspondence. Section 40 [Redacted]
SubjectV.F.O.

Section 40 [Redacted]
for APS/USofS(AF)
Section 40 [Redacted]

.....29th May 1990.....

P.S. Please could you let me have an answer to this correspondence
within a week of the date on this letter

0A/100/3431



Sec (AS)

DA

With Compliments

FROM SUPERVISOR B. WATCH
LATCC

National Air Traffic Services

A joint Civil Aviation Authority - Ministry of Defence Service

8



REPORT FORM

UNIDENTIFIED FLYING OBJECT

- A. 7am local 23/4/90
- B. ONE, 2 INCHES LONG, 1 INCH WIDE, EGG, STONE WITH WHITE AND BLACK SPECKLES. SUSPECTED METEORITE
- C. UPSTAIRS BEDROOM (SEE ADDRESS M)
- D. ~~NOT APPLICABLE~~ OBJECT SMASHED THROUGH WINDOW
- E. OBJECT CAME FROM NW
- F. NOT KNOWN.
- G. NOT APPLICABLE
- H. NOT KNOWN
- J. NOT KNOWN
- K. ~~NOT APPLICABLE~~

L. BRENTWOOD POLICE

Section 40

WPC

Section 40

M. THE OCCUPIER

Section 40

HATTON, ESSEX

N. NONE

O. NONE

P. ~~0920~~ 0920 23/4/90

Q.

Section 40

08407/23rd

Copy sent to MAIS date/time

ENCLOSURE
659

Section 40

Secretariat (Air Staff)2a



MINISTRY OF DEFENCE

Room Section 40

Main Building Whitehall London SW1A 2HB

Telephone: (Direct Dialling) Section 40
(Switchboard)

Section 40

Your reference

Our reference

D/Sec(AS)12/3

Date

8 June 1990

Dear

Section 40

Thank you for your undated letter to the Home Office on the subject of Unidentified Flying Objects (UFOs), which has been passed to the Ministry of Defence as the appropriate Government Department to reply.

You may find it helpful if I begin by explaining that while the Ministry of Defence does receive and co-ordinate some reports of UFO sightings, our sole concern is to determine whether or not they pose a threat to the security of the United Kingdom. Unless we judge that they do, and this has not been the case so far, we make no attempt to investigate further, or to identify whatever might have been seen.

Since our interest in UFOs is limited to possible defence implications, we do not carry out full time studies into the phenomenon, nor do we have the resources to undertake any in-depth investigations. The sighting reports we receive, which usually are limited to very brief details of what was witnessed, are referred to our staff in the departments concerned with the air defence of the United Kingdom, who examine them as a part of their normal duties.

It is clear from the reports we receive that there are many strange things to be observed in the sky, although we believe that rational explanations could be found for most of them. Possibilities that spring to mind include satellite debris re-entering the atmosphere, unusual cloud formations, meteorological balloons or aircraft seen from unusual angles, to name but a few. Indeed, we have yet to receive conclusive evidence that alien spacecraft have landed on the planet.

If you are interested in obtaining further information on this subject, you might wish to contact one of the civilian organisations engaged in study of the phenomenon. May I suggest the following societies:

British UFO Research Association

Section 40
[Redacted]

Contact International (UK)

Section 40
[Redacted]

who I am sure will be able to help you further.

I hope this is helpful.

Yours sincerely,

Section 40
[Redacted]

Section 40

Secretariat (Air Staff)2a

ENCLOSURE
649



MINISTRY OF DEFENCE

Room Section 40

Main Building Whitehall London SW1A 2HB

Telephone: (Direct Dialling) Section 40
(Switchboard)

Section 40

Your reference

Our reference

D/Sec(AS)12/3

Date

8 June 1990

Dear

Section 40

Thank you for your recent letter on the subject of an unusual sighting you witnessed on 7 April. I have been asked to reply.

You may find it helpful if I begin by explaining that while the Ministry of Defence does receive and co-ordinate some reports of UFO sightings, our sole concern is to determine whether or not they present a threat to the security of the United Kingdom. Unless we judge that they do, and this has not been the case so far, we do not attempt to investigate further, or to identify whatever might have been seen.

Given this limited involvement with the subject, the Ministry of Defence does not have any department which is appointed solely for the purpose of studying UFO reports, nor do we have any staff employed on the subject full time. The reports we receive, which are usually limited to very brief details of what was witnessed, are passed to staff in the departments concerned with the UK's air defences, who examine them as a part of their normal duties.

Since our interest in UFOs is limited to possible defence implications, we do not carry out studies or investigations into the phenomenon, nor do we have the resources to do so. I am sure you will appreciate that defence funds are already fully committed to maintaining the security of the UK, and meeting our responsibilities to allies and dependent territories. Therefore, we could not justify their use on scientific investigations unless a clear threat to the security of the UK had been identified.

In this context, I regret that I am unable to offer a definitive explanation for what you witnessed. Nevertheless, it is clear from the reports we receive that there are many strange things to be observed in the sky, although we believe that rational

explanations could probably be found for most of them. Possibilities that spring to mind include satellite debris re-entering the atmosphere, meteorological balloons, or aircraft seen from unusual angles, to name but a few.

I am sorry for the delay in replying to your letter. I hope that you will find this helpful.

Yours sincerely,

Section 40

ENGL
63

Section 40

Section 40, Secretariat (Air Staff) 2a



MINISTRY OF DEFENCE Room Section 40
Main Building Whitehall London SW1A 2HB

Telephone Section 40 (Direct Dialling)
(Switchboard)

Section 40

Your reference

Our reference

D/Sec(AS)12/3

Date

8 June 1990

Dear Section 40

Thank you for your letter of 9 April on the subject of Unidentified Flying Objects (UFOs). I apologise for the delay in replying.

I am sorry that you were not satisfied with my reply to your letter of 13 February. I am afraid that there is nothing I can usefully add to my earlier comments, other than to reiterate that the Ministry of Defence will not be investigating your reported experience further. It seems to me that there would be little value in a prolonged correspondence on this subject.

I am sorry that I cannot be more helpful.

Yours sincerely,

Section 40

ENCLOSURE No. 62

AMERICA'S UFO

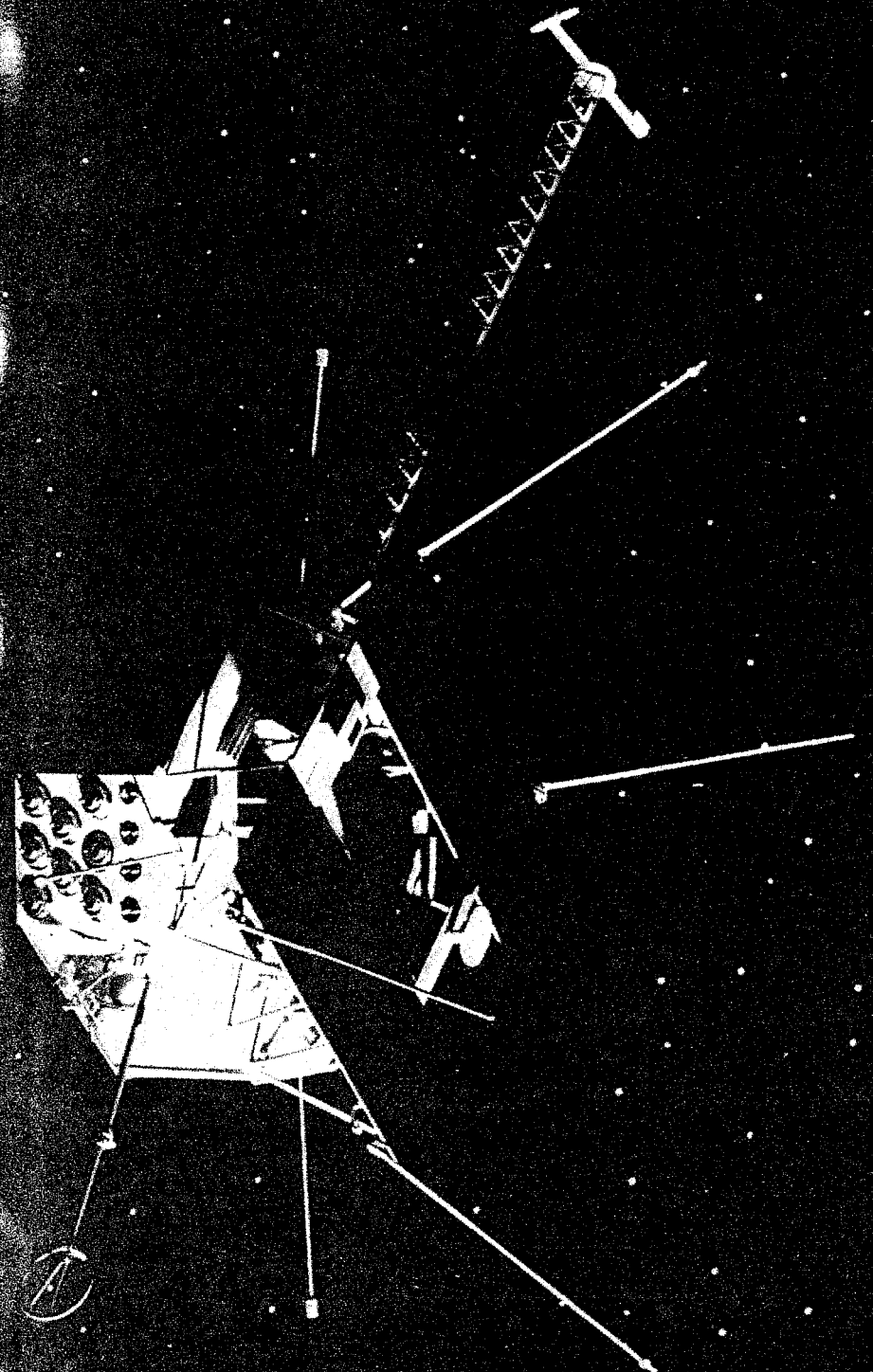

The Combined Release and Radiation Effects Satellite, CRRES, will become the first commercial customer of the General Dynamics Atlas booster this June and is likely to cause some "UFO scares", as Tim Furniss reports.

In a scene straight from a James Bond movie, CRRES circles the Earth silently and emits a jet of chemicals into space. These chemicals interact with the Earth's magnetic field and turn into huge clouds of greenish/red/yellow/blue particles.

Without a doubt, some observers are going to rush to their phones to report a UFO sighting. It is all in the cause of science, however.

The chemical-release experiment, which will be conducted in association with several sounding-rocket chemical release campaigns, are to further understanding of "...the interaction of plasmas with magnetic fields, the coupling of the upper atmosphere with the ionosphere; and the structure of low altitude electric fields", says Jerry Cox, NASA's project engineer, at the Marshall Space Flight Center, in Huntsville, Alabama. The chemical releases are just one objective of the joint CRRES programme, for the Department of Defense (DoD) and NASA.

CRRES will also help the DoD to study and map "...the effects of the natural radiation environment in space on spacecraft microelectronics; and irregularities in the ionosphere encountered when spacecraft reach the lowest point, or perigee of their orbits", according to US Air Force Col John E Armstrong, programme manager at the Air Force space systems division.

The magnetosphere, radiation belts and the ionosphere have an important and even critical bearing on the operation of spacecraft, their ability to collect and transmit data and to receive commands. The magnetosphere is the region surrounding the Earth where the planet's magnetic field interacts with a flow of ionised particles in the solar

Satellite will "paint" magnetic field with luminous particles recorded on board and on the ground

READY FOR SPACE

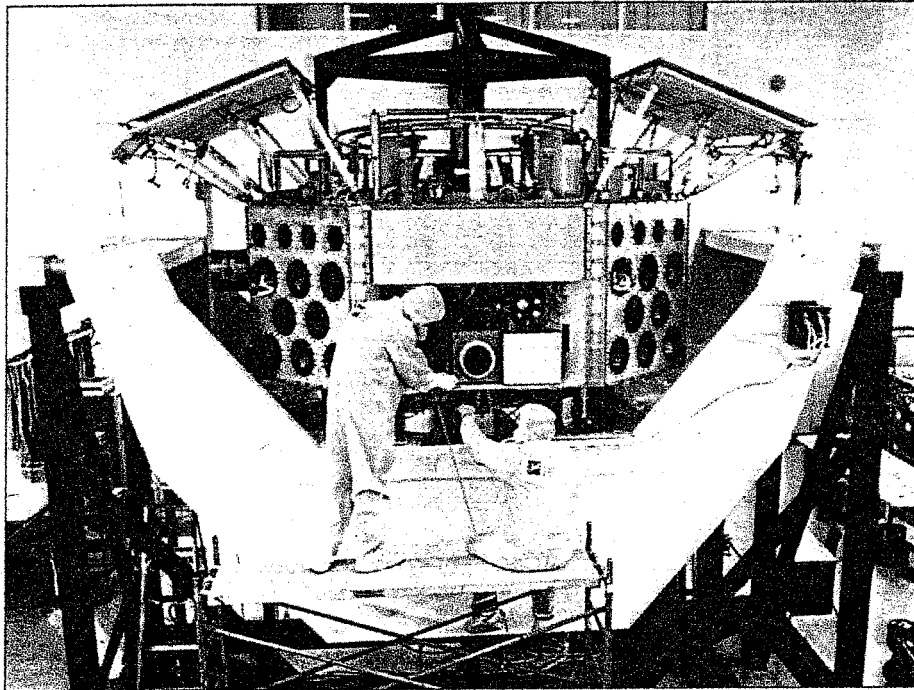

Engineers check cradled CRRES satellite in Ball Aerospace's clean room

wind from the sun. At 60,000km out from the sunward side, there is a bow shock, or shock wave, which defines the beginnings of the magnetosphere, where the solar wind first meets the Earth's magnetic field. Inside the bow shock is a turbulent region of ionisation known as the magnetosheath. On the opposite side of the Earth, the magnetosphere is drawn out to a great distance in the wake of the solar wind.

The magnetosphere also includes the "trapped" Van Allen radiation belts, which were discovered by the first US satellite, *Explorer 1*, in 1958. These are two regions in the upper atmosphere of the Earth, in which ionised particles spiral back and forth between the poles of the magnetic field. The lower region extends from 1,000km to 5,000km above the equator and contains protons and electrons captured from the solar wind. The upper region lies between 15,000km and 25,000km above the equator and mainly contains electrons.

The ionosphere, which extends from about 50km altitude, contains electrons and ions created by the impact of the Sun's ultra-violet radiation and solar wind on air molecules in the upper atmosphere. It has several distinct layers and degrees of ionisation, varying between the time of day, season, latitude and the state of solar activity.

THE SPACECRAFT

Like many NASA spacecraft built in the 1980s, CRRES has become a victim of the Space Shuttle programme and particularly the *Challenger* accident. It had been scheduled for a Shuttle ride into a 360km, 28° orbit, to eject 48 chemical canisters from four 12-canister modules for the NASA part of the experiment. Then its solid propellant motor was to have fired, to place it into a highly elliptical, approximately 400km by

35,000km, 18° orbit, for radiation effects studies by the DoD.

After *Challenger*, CRRES was redesigned by prime contractor Ball Space systems division, to fly an Atlas Centaur — since renamed Atlas 1 by General Dynamics. The solid propellant motor was scrapped and the launch will now be directly into the final elliptical orbit. The number of canisters was halved to 24, and the solar-cell panels were modified so that they could fit inside the Atlas payload fairing. The two solar panels provide 2.49kW of power.

Loaded with its chemicals, CRRES now weighs 1.72t, compared with its 7.5t Shuttle-weight. It measures 2.55m high and 1.89m in diameter and is octagonal in shape, incorporating two chemical modules, each housing eight large and four small canisters. These are split into eight large and eight small canisters of barium; six large canisters of lithium; one large canister of strontium; and one large canister of calcium.

The spacecraft attitude control system uses six hydrazine thrusters, with an initial thrust of 20N, petering down to 9N at end-of-mission, which maintains 2rpm spin-stabilisation. Science data is recorded in tape and transmitted at 16kbps to the ground two or more times a day. The Air Force Space Systems division will be responsible for spacecraft tracking and control, using the Consolidated Space Test Centre (CSTC) at Sunnyvale, California. The Air Force Satellite Control Network will be the prime communications point, with datalinks routed through Air Force remote tracking stations to the CSTC. Cheyenne Mountain Air Force base at NORAD "...will compute in-orbit satellite proximities to CRRES chemical releases and provide skin-track data", says the US Air Force.

The first commercial Atlas launch from

Pad 36B at Cape Canaveral will place CRRES and its attached Centaur second stage into a low Earth parking orbit, before the Centaur relights, to replace the spacecraft in a 350km by 35,786km orbit, with an inclination of 18° and an orbital period of ten and a half hours, during which it will plunge through the lower radiation belts and reach a perigee low enough to satisfy other mission objectives. It has a nominal one year's operation under the joint NASA/DoD programme, after which it will be handled by the DoD for possibly two more years of science studies, with control relinquished to NASA at the end of three years should it still be operating.

CRRES will be functioning on a 100% duty cycle for the DoD, while the NASA chemical releases will be timed to coincide with sounding-rocket campaigns and at specific points in the spacecraft's orbit, at perigee, apogee and at mid-altitudes of 1,000km and 3,000km. The near-Earth controlled releases will help understanding of the interaction of plasmas with magnetic fields, ionosphere-upper atmosphere interaction, the structure and chemistry of the ionosphere and the structure of electric fields. The near-apogee releases are designed to study the formation of "diamagnetic cavities; coupling between the magnetosphere and ionosphere; and the effects of artificial plasma injections upon the stability of the trapped particles in the radiation belts," says NASA. CRRES-related experiments have already been conducted from the joint DARPA-NASA Pegasus spacecraft which were launched by the OSC Pegasus booster in April.

THE CHEMICAL RELEASES

Two months after the launch of CRRES, NASA will conduct the South Pacific critical velocity releases at perigee. CRRES twice passes over the area during a moon-down period, timed at near dusk when plasma density is high and because at these longitudes the magnetic equator is north of the geographic equator, giving a favourable magnetic-field configuration for the experiment.

One release will eject barium and calcium and the other barium and strontium. This will be to test "...the critical ionisation velocity hypothesis, or the theory that anomalous ionisation of a neutral gas can occur in situations of high relative velocity between natural gas and a plasma", according to NASA. The potential release points will be Fiji-American, Samoa-French Polynesia, with major observations being made by aircraft positioned to allow triangulation of images.

During two successive moon-down periods, in December 1990 and January 1991, as CRRES reaches apogee in the tail of the magnetosphere near local midnight, four barium and three lithium releases will be conducted, to test the response of the magnetosphere. The effects are expected to include the generation of waves; stimulation

of electron and proton precipitation; and the transport of the ejected barium and lithium ions over a large volume of the magnetosphere. The release points will be chosen so that the magnetic field line threading the release region reaches the Earth over eastern USA and Canada, and to a conjugate point in South America.

The releases will be observed with a network of optical ground sites in the USA, Canada, Argentina, Chile, Brazil and Peru; the incoherent scatter radar at Millstone Hill, Massachusetts, viewing the foot of the magnetic field line; and four aircraft - a NASA DC-8 and Air Force KC-135, flying parallel tracks near the foot of the field line in eastern Canada; an additional aircraft on the west coast of the USA; and an Argentine Boeing 707, deployed near the conjugate field line foot in South America. Real-time monitoring of the plasma and magnetic field state of the magnetosphere will be made by CRRES on board instruments.

A series of five to seven releases will be made over the Caribbean region between May and July 1991, in conjunction with five sounding-rocket releases, launched from Puerto Rico. One of the CRRES releases will be at the western end of the Caribbean because of the requirement to be on the magnetic field line that goes over the radar at Jicamarca, Peru. The releases, with one exception, are designed to launch ions upward along the magnetic field lines and to have the ions observed during their entire transit along the field line to the conjugate point over South America.

Observations will be made with an extensive network of ground optical and portable VHF coherent scatter radars in the Caribbean and South America, plus four aircraft.

The DoD's interest in CRRES centres on the study of the effects of radiation on spacecraft micro-electronics. While CRRES flies into the lower and outer radiation-belts of the Earth, the latest microelectronic components on the spacecraft will be tested and radiation measured accurately, using four 50m wire booms, a magnetometer and a 6m mast with Langmuir probe. Another experiment will use four 2m probes and a magnetic loop antenna. More than 40 instruments will be operated, including experimental new high-performance solar cells and instruments which are investigating the effects of solar flares and cosmic rays on the Earth's magnetosphere and radiation belts.

DoD EXPERIMENTS:

The DoD experiments are:

- the High Efficiency Solar Panel, for the Air Force Systems Command, to determine the performance and radiation hardness of gallium arsenide solar cells under radiation and under ambient temperatures. Gallium arsenide cells may replace silicon cells which are used at the moment because they can generate higher quantities of electricity.

- Spaceraid, for the Air Force Geophysical Laboratory, consists of 30 instruments which expose microelectronics to the space environment.

- Solar Flare Isotopes experiment, for the Office of Naval Research, measures the cosmic-ray particles and heavy ion composition in the magnetosphere.

- Heavy Ions Experiment, provided by the same office, measures the intensity, energy, and pitch angles of low, medium and high energy ambient ions.

In conjunction with the NASA chemical releases on some orbital passes, another DoD experiment, for the Naval Research Laboratory, will study naturally occurring and artificially produced ionospheric perturbations and the effects of these perturbations on communications. The onboard set of instruments consists of two pulsed plasma probes, a very-low-frequency wave analyser, including two electric field antennas; a magnetic loop antenna and a quadrupole ion mass spectrometer. □

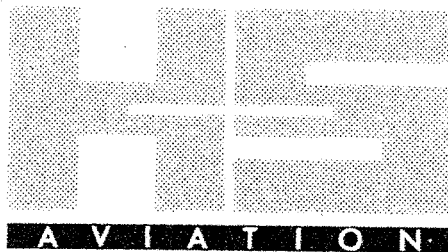

Drawing on Team Experience

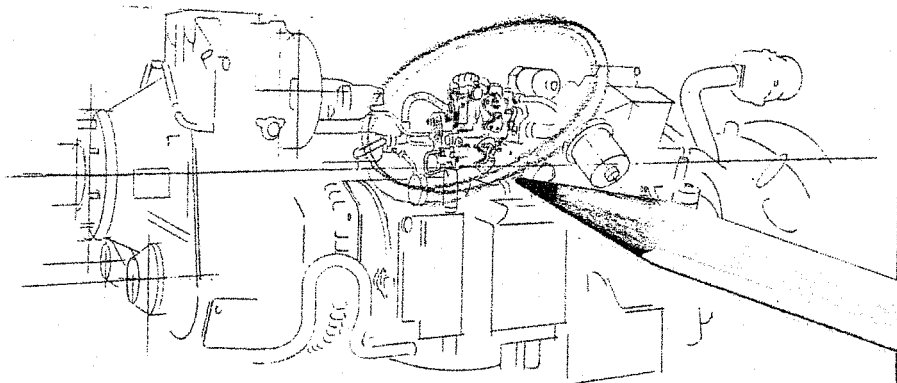

Bendix Avelox P108 F.C.U.



H+S AVIATION IS THE SOLE BENDIX AVELEX EUROPEAN AUTHORIZED WARRANTY AND REPAIR STATION FOR THE P-108 FUEL CONTROL UNIT.

H+S AVIATION LIMITED, AIRPORT SERVICE ROAD, PORTSMOUTH, HAMPSHIRE PO3 5PJ ENGLAND.
TELEPHONE 0705 694981, INTERNATIONAL +44 705 694981, FAX 0705 670558.
TELEX 86403 HXS G.SITA P.MEHXCR.



with the compliments of
MINISTRY OF DEFENCE

Section 40 [Redacted]

- MOD SY 16.

Section 40

Sec (AS) 2a.

Section 40 [Redacted]

3/5
NFA

We spoke today.
The attached may be of
interest to you as you have
some knowledge of the
author.

Section 40 [Redacted]

1/25/5.

File: 12/3



OPERATION GRAIL - Security Classification C O S M I C

CONTACT WITH EXTRA-TERRESTRIAL INTELLIGENCE VEHICLE AT MIDSUMMER SOLSTICE. MIDSUMMER MOMENT IS 15.33'44" GMT THURSDAY JUNE 21 1990.

+

1. THE VEHICLE WILL EMERGE FROM THE OCEAN NORTH OF THE UK AND, IN ORDER TO COMPLETE ONE ORBIT OF THE PLANET IN 24 HOURS, WILL IMMEDIATELY ADOPT THE NECESSARY SPEED OF PASSAGE OF APPROX 1040 MPH, ABOUT 500 YARDS PER SECOND. IT WILL MOVE FROM NORTH TO SOUTH ACROSS THE UK IN A STRAIGHT LINE AT AN ALTITUDE OF 1000' ON CONTOUR-LOCK ABOVE LAND AND SEA, OVER-FLYING THE 555 MILES IN 32 MINUTES, ENTERING UK AIR-SPACE OVER THE ISLE OF LEWIS AT 15.17 HRS, PASSING BETWEEN THE ISLANDS OF RHUM AND EIGG, WEST OF SCOTLAND: ABOVE GREY ABBEY, NORTH-EASTERN IRELAND: OVER MERLIN'S BRIDGE, SOUTH-WESTERN WALES: ABOVE TINTAGEL CASTLE, WESTERN ENGLAND: CLEARING UK AIR-SPACE OVER THE SOUTH COAST AT 15.49 HRS.

2. DIVIDING THE TRACK INTO EIGHTHS, OR DISTANCES OF ABOUT 70 MILES, EACH POINT BEING 4 MINUTES APART, THE FOLLOWING IS REVEALED:

- ENTERS UK AIR-SPACE AT 15.17 HRS - ISLE OF LEWIS
- .21 - ISLE OF SKYE
- .25 - ISLE OF MULL
- .29 - MULL OF KINTYRE
- .33 - GREY ABBEY, COUNTY DOWN
- .37 - OVERSEA, WEST OF ANGLESEY
- .41 - OVERSEA, APPROACHING FISHGUARD
- .45 - OVERSEA, BETWEEN WALES AND CORNWALL
- LEAVES UK AIR-SPACE AT 15.49 - ST AUSTELL BAY

3. ON MOD PICK-UP, SCRAMBLE FIVE R.A.F. PHOTO-PHANTOMS AND ESCORT FOR DURATION OF UK PASSAGE FILMING VEHICLE FROM A DISTANCE OF 1000 FEET. NO CLOSER. ONE AND TWO LEVEL EITHER SIDE; THREE LEVEL BEHIND; FOUR 1000' IMMEDIATELY ABOVE. FIFTH AIRCRAFT TO BE 4000' ABOVE THE 'VEHICLE + 4' FORMATION BENEATH, TRANSMITTING 'LIVE' PICTURES FOR INSTANTANEOUS VIEWING, TAPING, AND LATER STUDY.

4. TO OVERCOME FUEL LIMITATIONS, SUGGEST 'BATON' THEORY. FIVE TAKING OVER FROM FIVE ALONG DURATION OF TRACK.

5. THE VEHICLE IS GULL SHAPED, TO NEGOTIATE PLANETARY ATMOSPHERES AND INTER-STELLAR REGIONS. IT WILL BE SURROUNDED BY A VERY STRONG MAGNETIC FIELD, POSSIBLY INTERRUPTING SURVEILLANCE EQUIPMENT. SUGGEST WE FILM THROUGH PROTECTIVE SHIELDS (?) OVERCOMING RADIATION AND FILM FOG.

+

6. THE TRACK IS GIVEN BUT IT MAY LAND. IN WHICH CASE WE APPROACH. TEAMS OF EIGHT, OF FOUR MALE AND FOUR FEMALE ARMED FORCES PERSONNEL ARE TO BE PLACED ABOARD A SERIES OF HELICOPTERS STANDING BY ALONG TRACK. SUGGEST ONE AT EACH POSSIBLE LANDFALL, i.e. LEWIS / SKYE / MULL / JURA / KINTYRE / GREY ABBEY / FISHGUARD / BOSSINEY / ST AUSTELL.

7. ONCE ABOARD THE VEHICLE, TEAM WILL BE FREE TO MAKE AUDIO AND VISUAL RECORDS OF ALL SEEN AND HEARD. EACH MEMBER OF EACH TEAM TO BE INDIVIDUALLY WIRED TO PERSONAL TAPE, ALLOWING INDIVIDUAL SPOKEN RECORD DURING MOVEMENT. DIRECT CONTACT WITH 'OUTSIDE' MAY BE PREVENTED BY HULL INSULATION.

8. AFTER INSPECTION CREW HAS DISEMBARKED FOR INTERNAL INSPECTION, THEIR HELICOPTER WILL RISE AND CIRCLE, FILMING THE VEHICLE UNTIL CREW DISEMBARKS WHEN PHANTOMS WILL BE ALERTED TO CONTINUE SURVEILLANCE. IT MAY LAND AT SEA.

9. FROM EYEBALL CONFIRMATION AT THE TIME OF UK AIR-SPACE ENTRY, DELIVER ALL COMPLETED RECORDS FROM GROUND, SEA, AND AIR, TO A MANCHESTER ASSEMBLY POINT, WHERE IT IS TO BE ASSEMBLED IN SEQUENCE INTO ONE INTELLIGENT INTERPRETATION OF THE HALF-HOUR PASSAGE. WHEN COMPLETE, MAKE TEN COPIES, PASSING ONE TO BBC TELEVISION FOR SHOWING TO THE UK AUDIENCE, ALL CHANNELS SIMULTANEOUSLY, WITHIN 24 HOURS. ALLOW 48 HOURS TO ELAPSE THEN RELEASE TO GLOBAL MEDIA. RE-SHOW TO UK AUDIENCE SEVEN DAYS AFTER ORIGINAL SHOWING.

10. EXCEPTION TO THE ABOVE IS THE MATERIAL SHOW FROM PHOTO-PHANTOM NO.5 WHICH IS TO BE HELD AND SEEN ONLY BY MOD PERSONNEL.

+

Good luck.

MONDAY MAY 7 1990 / 20.36 HRS

Section 40



RGY 15

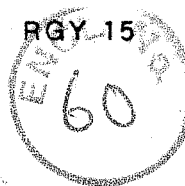

Tel No: Section 40

FROM HOME OFFICE
REGISTRY SERVICES
ROOM Section 40
QUEEN ANNE'S GATE

TO MOD

DOCUMENT TRANSFER
APR 1990
COMMUNICATIONS UNIT

1. The document attached appears to be appropriate to your Department:
2. Details of any previous correspondence (if any)

3. Writer/No. 10 Downing St. has not been informed.

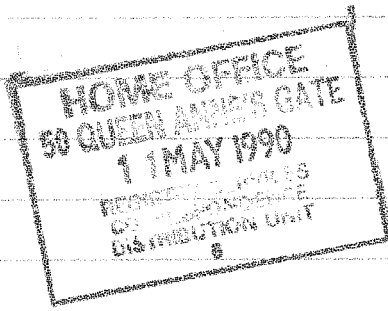

Perran-ar-worthal school,
School Hill
Perranwell Station
Truro,
Cornwall
TR3 / LA

Dear Sir or Madam,

This is a letter from Section 40 in Cornwall

I am doing a project on UFOs and I wonder if you could help me. I am looking for quiet a lot of information if you can please because I am aiming to do quiet a big project.

I am interested in UFOs because I have got about 10 books on them with photos in with strange objects in them flying in the air. I believe that flying saucers are true and they come from another planet. I would dearly like a reply.

yours faithfully,
Section 40

Home office.

Whitehall,

London.



POST OFFICE
LONDON
E.C. 4



HEADLINES

ever-closer links

more efficient. We intend to make it more attractive to travel with our group." Where SAS had previously entered marketing agreements with other airlines, and co-ordinated scheduling resulted, marketshare rocketed, he points out.

Swissair president Otto Loeper says that McDonnell Douglas and Airbus Industrie will be asked to bid for "a potential market of more than 200 aircraft" for the group.

The airlines joined forces last month (*Flight*, 4-10 April, P 11) to invite A320 and MD-90 proposals, having decided the Boeing 737 will be technically outclassed in the late 1990s.

Separate airline identities will

be maintained, insist all the executives: "We do not want to participate in the merger mania that is going on at the moment," says Papousek.

From now on, says Papousek: "New markets will be evaluated jointly, and solutions produced jointly." Current schedules will be reorganised to eliminate superfluous duplication and fill unserved spaces; hubbing schedules will dovetail; passenger lounges and check-in desks will be operated jointly, he says.

Carlzon says that he does not foresee any political opposition to the co-operation, even from the EC—to which SAS is linked by Denmark's share in the Scandinavian airline. □

Delay hits Open Skies agreement

The prospect of an Open Skies Treaty being signed in Budapest by 12 May appears remote. Progress has been slowed by disagreements over the surveillance equipment permissible, the dissemination of information and the question of out-of-area overflights.

The second round of the Conference on Open Skies aims to reach an agreement on the overflight of unarmed surveillance aircraft across the territory of opposing military blocs. Delegations from the 23 member countries of NATO and the Warsaw Pact are meeting in Budapest to agree a code of conduct for such verification flights.

The comparability of monitoring equipment is one area of disagreement. The Soviet Union has so far objected to the inclusion of the more-sophisticated surveillance hardware which it believes would turn inspection flights into reconnaissance missions. Imbalances in the equipment available to the two sides will have to be resolved.

During the Ottawa negotiations preceding the Budapest conference, the US delegation's view was that information collected should not be revealed to

the other side. The Soviet Union, on the other hand, believes that a common databank should be established to allow information to be accessed by all treaty member countries.

The third sticking point is the question of overflying those countries outside NATO and the Warsaw Pact in which treaty signatories have military interests. The USA is reluctant to allow overflights of its military bases in Japan, for example.

According to Conference secretary-general Andre Erdos, the prospect of compromises on these issues is good. "It should be agreed within the next few days how the Conference can proceed. Certainly a Treaty should be ready this year," he says. Agreement on the quota of flights which each side can conduct is close and Erdos is confident that the USA and USSR can sort out their differences through the forthcoming ministerial and summit meetings. □

RN offered AEW V-22

BY SIMON ELLIOTT

British Aerospace has briefed the UK Royal Navy on an airborne-early-warning (AEW) variant of the Bell-Boeing V-22 Osprey tilt-rotor with modifications for operations from Royal Navy Invincible-class light aircraft carriers.

BAe has a bilateral agreement with Bell-Boeing to evaluate tilt-rotor technology and to determine UK markets for military or civil tilt-rotor aircraft. The AEW briefing was one of several given to the services covering potential V-22 roles. BAe says that it has "... briefed all missions to the Royal Navy, the Army and the Royal Air Force".

The major V-22 modification for the RN is the introduction of a folding tail allowing the aircraft to use Invincible-class carrier lifts. According to BAe, this change saves airframe weight. The folding tail is common to all V-22 variants on which BAe has briefed the Navy.

Four main radar installations have been examined for the AEW V-22, including an E-2-style rotodome, nose-and-tail arrange-

ment, AEW Sea King-type fold-out antenna and conformal radars mounted on the fuselage sides above the sponsons. Boeing has windtunnel-tested various AEW configurations and the rotodome is thought to be the current favourite.

The AEW V-22 would loiter at around 15,000ft (4,500m) with a radius of action of some 370km (200nm) and the 2.5h on-station time would increase to 5.5h with inflight refuelling.

Other missions briefed to the Navy include long-range anti-submarine, anti-surface-ship and mine warfare, air-to-air refuelling, fleet replenishment and search and rescue. The Army and the RAF have been briefed on the strategic and tactical transport, airmobility, commando assault, battlefield surveillance, search and rescue and electronic countermeasures missions.

Costs of a specialised V-22 for any UK roles are still dependent on the aircraft's success in the USA, but if a V-22 were to cost \$25-30 million, a specialised version would cost around twice as much, says BAe. □

Depiction of AEW Osprey operating from HMS Invincible

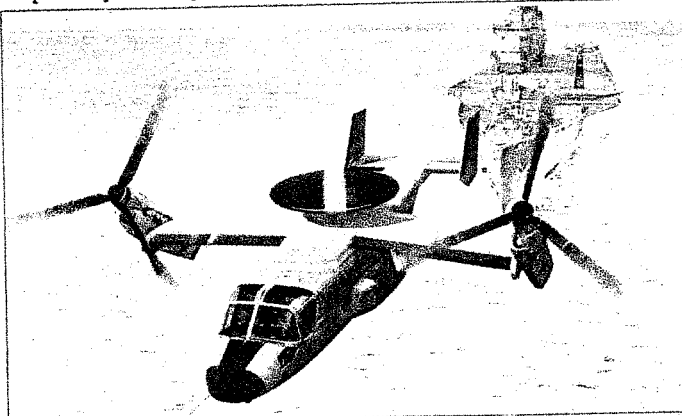

1000 READY TO RUN

The British Aerospace 1000 business jet prototype will this week begin engine runs at the company's Chester factory in preparation for a maiden flight scheduled for the first week of June. The aircraft might not appear at September's Farnborough show, however.

NEWS IN BRIEF

F-117 HEADS FOR UK

US Air Force Lockheed F-117A stealth fighters from the 37th Tactical Fighter Wing, based at Nellis AFB, Nevada, are expected to deploy to RAF Alconbury by mid-1990.

SABCA ASSEMBLES A.109

SABCA of Belgium and Agusta of Italy have signed the agreement covering the assembly of 46 Agusta A.109 MkII helicopters for the Belgian Army. The aircraft will fulfil Belgium's Aeromobility I requirement for 28 anti-tank and 18 observation helicopters.



MINISTRY OF DEFENCE
Main Building Whitehall London SW1A 2HB

Telephone **Section 40** (Direct Dialling)
(Switchboard)



Section 40

Your reference

Our reference

D/Sec(AS)12/3

Date

9 May 1990

Dear

Section 40

Thank you for your letter of 22 March on the subject of Unidentified Flying Objects (UFOs) to the Royal Air Force, which has been passed to the Ministry of Defence for reply.

It may be helpful if I begin by explaining that while the Ministry of Defence does receive and co-ordinate some information about UFO sightings, our sole concern is to determine whether or not they present a threat to the security and defence of the United Kingdom. Unless we judge that they do, and this has not been the case so far, no attempt is made by MoD to investigate or identify the objects.

Given this limited involvement with the subject, the Ministry of Defence has no department which is appointed solely for the purpose of studying UFO reports, nor are there any staff employed on the subject full time. The reports we receive, which are usually limited to very brief details of what was witnessed, are examined by staff in the departments concerned with the UK's air defence as a part of their normal duties.

The Ministry of Defence does not carry out studies, investigations or surveys into the UFO phenomenon, nor do we have the resources to do so. I am sure that you will appreciate that Defence funds are already committed to maintaining the security of the UK and meeting our responsibilities to allies and dependent territories. Therefore, we could not justify their use on scientific investigations unless a clear threat to security had been established. It therefore follows that the majority of sightings passed to us remain, by definition, unidentified, though we believe that rational explanations could be found for most of them. Possibilities that spring to mind include satellite debris, meteorological balloons and aircraft seen from unusual angles, to name but a few.

I hope this is helpful.

Yours sincerely,

Section 40

From: **Section 40**

Secretariat (Air Staff)2a, Room **Section 40**

phoned 4/5/90



3 March.

Large Red light sighted, Liverpool, Blackburn
Chorley, ~~seen~~ seen by lots of
people, reported to Chorley police.
Helicopter ~~is~~ spotted chasing it.

Somerset 6 April

Met policeman saw Large Red light
reported to Somerset police

Taunton Somerset 28 April. 3.30 Am.

Woman woken by dog - saw huge
ball of red light - described as
size of orange at arms length
Woman's son also saw this - lasted 4 min
+ then moved away quickly
Reported to Taunton police.



MINISTRY OF DEFENCE

Main Building Whitehall London SW1A 2HB

Telephone **Section 40** (Direct Dialling)
(Switchboard)



Section 40

Your reference

Our reference

D/Sec(AS)12/3

Date

2 May 1990

Dear

Section 40

Thank you for your report of an unusual sighting you witnessed on 5 April.

It may be helpful if I begin by explaining that while the Ministry of Defence does receive and co-ordinate some information about UFO sightings, our sole concern is to determine whether or not they present a threat to the security and defence of the United Kingdom. Unless we judge that they do, and this has not been the case so far, no attempt is made by MoD to investigate or identify the objects.

Enquiries have not revealed any high level air traffic flying South over the Kingsdown area at the time of your sighting. I regret that I am therefore unable to offer a definitive explanation for what you witnessed. However, it is clear from the reports that we receive that many strange things have been observed in the sky, although we believe that rational explanations could probably be found for most of them, possibilities include satellite debris re-entering the earth's atmosphere, unusual cloud formations, meteorological balloons and a host of other things. I hope that you will accept that because no threat has been established, the Ministry of Defence will not be investigating. Nevertheless we are grateful to you for taking the time to make a report.

I hope this is helpful.

Yours sincerely,

Section 40

From: **Section 40** Secretariat (Air Staff)2a, Room **Section 40**

100/1
455

Section 40

From: Section 40 Secretariat (Air Staff)2a



MINISTRY OF DEFENCE Room Section 40

Main Building Whitehall London SW1A 2HB

Telephone Section 40 (Direct Dialling)
(Switchboard)

Section 40

Your reference

Our reference
D/Sec(AS)12/3

Date

30 April 1990

Dear Section 40

Thank you for your letter of 17 April on the subject of Unidentified Flying Objects (UFOs) in which you requested any information we might be able to provide on a sighting in October 1986.

As you are aware, the Ministry of Defence has only a very limited involvement with this subject. I am afraid that I can be of little help with this enquiry, as we have neither the staff nor the resources to enable us to conduct research into anything other than recent events. However, a search of our files has revealed that the Ministry of Defence did not receive any reports at that time.

I am sorry that I cannot be more helpful.

Yours sincerely,

Section 40

ENCL NO
54

Section 40

Secretariat (Air Staff)2a



MINISTRY OF DEFENCE Room Section 40

Main Building Whitehall London SW1A 2HB

Telephone Section 40 (Direct Dialling)
(Switchboard)

Section 40

Your reference

Our reference

D/Sec(AS)12/3

Date

4 May 1990

Dear

Section 40

Thank you for your letter of 9 April in which you requested any information we might have on several reported UFO sightings in February 1990.

A search of our files has revealed that the Ministry of Defence did not receive any reports from RAF Newton on the dates you specify, or indeed on any other dates in January or February. Therefore, I regret that we are unable to be of assistance on this occasion.

I am sorry I cannot be more helpful.

Yours sincerely,

Section 40

ENCLOSURE
53

Section 40

From: Section 40 Secretariat (Air Staff) 2a



MINISTRY OF DEFENCE Room Section 40
Main Building Whitehall London SW1A 2HB

Telephone Section 40 (Direct Dialling)
(Switchboard)

Section 40

Your reference

Our reference
D/Sec(AS)12/3

Date
30 April 1990

Dear Section 40

Thank you for your letter of 2 April on the subject of Unidentified Flying Objects (UFOs).

As you are aware, the Ministry of Defence has only a very limited involvement with this subject. The documents to which you refer would seem to be a typical pair of reports. As I have said previously, such reports are passed to staff in the departments concerned with the UK's air defences, who would examine them as a part of their normal duties, in order to determine whether or not any threat to defences had occurred.

I hope this is helpful.

Yours sincerely,

Section 40

Section 40

ENCL NO
52

From: Section 40 Secretariat (Air Staff) 2a
MINISTRY OF DEFENCE Room Section 40
Main Building Whitehall London SW1A 2HB
Telephone: (Direct Dialling) Section 40
(Switchboard)



Section 40

AMSTERDAM
Netherlands

Your reference

Our reference
D/Sec(AS)12/3

Date
30 April 1990

Dear Section 40

Thank you for your letter of 15 January to Westminster City Hall, on the subject of Unidentified Flying Objects (UFOs), which has been passed to the Ministry of Defence for reply.

You requested the addresses of UFO societies in this country. May I offer the following suggestions:

British UFO Research Association, Section 40
Section 40

Contact International (UK), Section 40
Section 40

who I am sure will be able to provide you with more information.

I am sorry for the delay in replying to your letter. I hope this is helpful.

Yours sincerely,
Section 40



From Squadron Leader [Section 40] RAF

ROYAL AIR FORCE PRESENTATION TEAM

Royal Air Force Staff College
Bracknell Berks RG12 3DD

Telephone Bracknell [Section 40]

20/4/90

[Section 40]
I will respond with the standard letter. This is quite a good one.

Sec (AS) 2
MOD
Main Building
Whitehall
London
SW1A 2HB

[Section 40]

RAFPT/30/BRA

[Section 40]

[Section 40]

as - make your reply (as always) "informed, impartial comment"

26 April 1990

[Section 40]

4/5

UFO ENQUIRY

Please find attached a copy of a letter from [Section 40] who attended the RAF Presentation in Bradford. I would be grateful if you could respond with the 'party line!'.

Yours Sincerely

[Section 40]

[Section 40]

Please send a copy of our reply to Sqn Hdr [Section 40] with compliments of Sec(AS) etc.

[Section 40]

Dep ltd. - please return

Section 40

Section 40

Telephone: Section 40

22nd March, 1990

Dear Group Captain Section 40

I apologise for my delay in taking up your kind offer to discover for me if the Royal Air Force has a Facility for dealing with enquiries of a ufological nature. As I think I said when we spoke in Bradford, the M.O.D. are unfortunately recalcitrant in such matters, and who can blame them? The subject, even after forty years of public existence, is still fraught with sociological stigma. In any case I doubt if they have the necessary expertise to comment conclusively. Such expertise, if UFOs are indeed a genuine aerial anomaly, must fall within the brief of the Royal Air Force, if only on the grounds that if something is up there then Aircrew are the most likely individuals to bump into it on occasion.

For my part I feel that most public ufology devolves from a simple case of 'wish fulfillment', which has hung its extra-terrestrial hat on a series of misperceptions and misconceptions. The difficulty is of course - how do you 'prove' a negative? And it is in this area that I am hopeful that the Royal Air Force can help. Because of the duties the Service is called upon to perform, the possibilities for 'misperception' must be well known in order to obviate any possibility of causing WWII by accident. Therefore any comment made by the Service on ufological reports must be taken as being highly informed.

In making this request I would assure you that I am not poised to inundate the Royal Air Force with the kind of demands now being inflicted on your American equivalent (it is their own fault - the Freedom of Information Act was, in many ways, tantamount to giving the inmates the keys to the sanatorium), rather I would hope to elicit the kind of informed impartial comment necessary to dissipate the emotional overloading of that vanishingly small percentage of reports which, presumably because of paucity of data, resist mundane explanation.

I thank you in anticipation of your kind attention.

Yours sincerely,

Section 40

Section 40

Section 40

Phoned.

20/4/90

Bristol 11.55 airport. Saturday



Section 40

Senior Air Traffic Control officer

Bristol Lulsgate

Section 40

civil airport

Bristol Filton

Section 40

save Bristol airport call on 20/4 to see whether there was any unusual activity around Bristol

Bristol ATC got back on 23/4 to say that there had been no unusual activity either prior to or on Saturday night. Nothing ~~at~~ $\frac{1}{2}$ hour either side of 11.55 (pm) in air traffic terms.

Section 40

23/4

Note: Section 40 phoned 1 May 1990 to say that he had got his prediction wrong and that the UFO had turned up near Bristol Airport on 28th April at 11.55.

From:

Section 40

Secretariat(Air Staff)2a



MINISTRY OF DEFENCE

Room Section 40

Main Building Whitehall London SW1A 2HB

Telephone: (Direct Dialling) Section 40
(Switchboard)



Section 40

Your reference

Our reference

D/Sec(AS)12/3

Date

20 April 1990

Dear

Section 40

Thank you for your letter of 26 March on the subject of Unidentified Flying Objects (UFOs), in which you requested any information we might be able to provide.

It may be helpful if I begin by explaining that while the Ministry of Defence does receive and co-ordinate some reports of UFO sightings, our sole concern is to determine that they pose no threat to the security of the United Kingdom. Unless we judge that they do, and this has not been the case so far, we do not attempt to investigate further, or to identify whatever might have been seen.

Given this limited involvement with the subject, the Ministry of Defence has no department which is appointed solely for the purpose of studying UFO reports, nor are there any staff employed on the subject full time. The reports we receive, which are usually limited to very brief details of what was witnessed, are examined by staff in the departments concerned with the UK's air defence as a part of their normal duties.

The Ministry of Defence does not carry out studies, investigations or surveys into the UFO phenomenon, nor do we have the resources to do so. I am sure that you will appreciate that Defence funds are already fully committed to maintaining the security of the UK and meeting our responsibilities to allies and dependent territories. Therefore, we could not justify their use on scientific investigations unless a clear threat to security had been established. It therefore follows that the majority of sightings passed to us remain, by definition, unidentified, though we believe that rational explanations could be found for most of them. Possibilities that spring to mind include satellite debris, meteorological balloons and aircraft seen from unusual angles, to name but a few.

I hope that you will find this helpful.

Yours sincerely,

Section 40

Section 40

Section 40



The Head of Department,
Department S4 (Air),
The Ministry of Defence,
Main Building,
Whitehall,
London SW1A 2HB

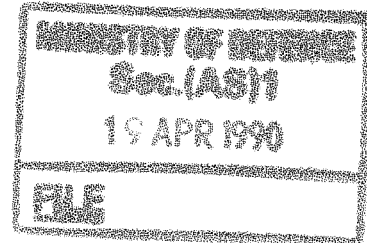

Dear Sir,

Sighting of Object - Scottish Borders, Saturday April 7, 1990.

I understand from my copy of *Who Decides What: The Citizen's Handbook* by Klaus Boehm and Brian Morris that it is to your department that I must write to log the rather strange experience I had last Saturday night. This incident was also reported at the time to the village policeman, Pc. [redacted] of Dumfries and Galloway Constabulary.

Section 40

On the evening of Saturday April 7 I had been quite content in front of my television set until, at approximately 20.50 hours BST, I received a telephone call from Councillor [redacted] [redacted] of Bromsgrove. In consequence of this call, and with the advantage of a cordless telephone unit, I left the comfort of my fireside to collect some papers from my study. I then chatted with her from the study and from various other rooms in the house. Around 21.00 I entered my darkened kitchen for no other reason than as part of my general meanderings.

In the kitchen I noticed an exceedingly bright light which, for a second or two, I assumed it to be one of those high standard lights familiar to many major motorway junctions. Now living in the country it dawned on me that the nearest thing like that was at least seventy miles distant. Obviously the light deserved closer examination. My spectacles yielded no new information - they served only to heighten my curiosity - so I then fetched a pair of binoculars.

From my observations I detected four very bright lights, one of which was clearly visible. I also remember being struck by the perfect oval of whatever was surrounding this particular light. The object was, at best guess, between half and three-quarters a mile distant.

At 21.03, whilst describing all this to [redacted] [redacted] the thing gave the impression of movement. No sooner had I remarked on this than it streaked off southwards, and at a rate of acceleration I found difficult to comprehend. Suddenly it turned (not banked) eastwards and, though hardly larger than a star, remained bright enough to track until it became obscured by my neighbour's garage.

I completed my call at 21.20 and telephoned [redacted] [redacted] directly after that.

Had I not been talking to someone, had I not reported it, and had I not made the notes on the telephone pad (enlarged photocopy enclosed), I would now say I had been dreaming. Even the unreality of the whole episode seems worthy of comment.

From the enclosed photocopy you will see the rough and ready sketch of the scene which I made immediately afterwards.

My home is one of ten bungalows arranged in a square, and I am at the centre of the three which form the southern flank. It can be found on the O.S. 1:50,000 series, Sheet 85, at grid **Section 40**. My kitchen is to the rear of my property, facing due south. From the kitchen window, which is fairly central to the length of the house, the view is very much as described. I also found a recent (if poor) photograph of the sunset which was taken to use up the spool. It bears no relation to the events of Saturday 7 other than to clarify the shortcomings of my artwork. (The camera was an Olympus XA2 with its standard 35mm. lens.)

The mysterious object was at the position marked 'x', and at a bearing of 3175 mils magnetic. Using the less than symmetrical tall tree as the centre of arc, and the right-hand side of my neighbour's garage as left of arc, the object remained within that area until the time contact was lost.

I am well aware what the sighting was not:

- * The moon. It was full, much higher in the sky, well off to the left, and very visible.
- * The stars. These were not yet visible from the kitchen window and the object could never have been mistaken for one until it was some considerable distance away.
- * It was not an overhead light of a permanent or even temporary nature.
- * Nor was it an aircraft.
 - There was no noise, either the distinctive sound of a helicopter or the roar of the Harrier's Rolls-Royce Pegasus engine.
 - The smoothness, the speed, and apparent right angled turn associated with its departure could not have been replicated by either of the above aircraft.
 - The lights would have been impossible to mount particularly when, unfocussed into any sort of a beam, they would seem to be singularly valueless.
- * Reflections, either from internal or external sources.
- * Transposition of other light or features due to atmospheric conditions.
- * Other local lighting. Save for The Croft's garage light with which I am familiar, there is no other source of illumination until the lights of Longtown and CAD Longtown at half-right and right of arc respectively.

Other than *Who Decides What* the only other book in my collection that makes any reference to UFOs is the *Dictionary of Misinformation* by Tom Burnam. It doesn't give much thought to them, merely reporting the sightings as "cigar-shaped forms resembling airships". I doubt my unidentified flying object meets such a criterion, even if it cannot match any other designation.

I trust that you will find these comments of help. I know that despite the eccentric quality of UFOs the matter is not treated without some regard to their potential seriousness.

Yours faithfully,

Section 40

Sat. (th April 1990



View South from Wynnecote
 (Landranger Series: Sheet 85, Grid Section 40)

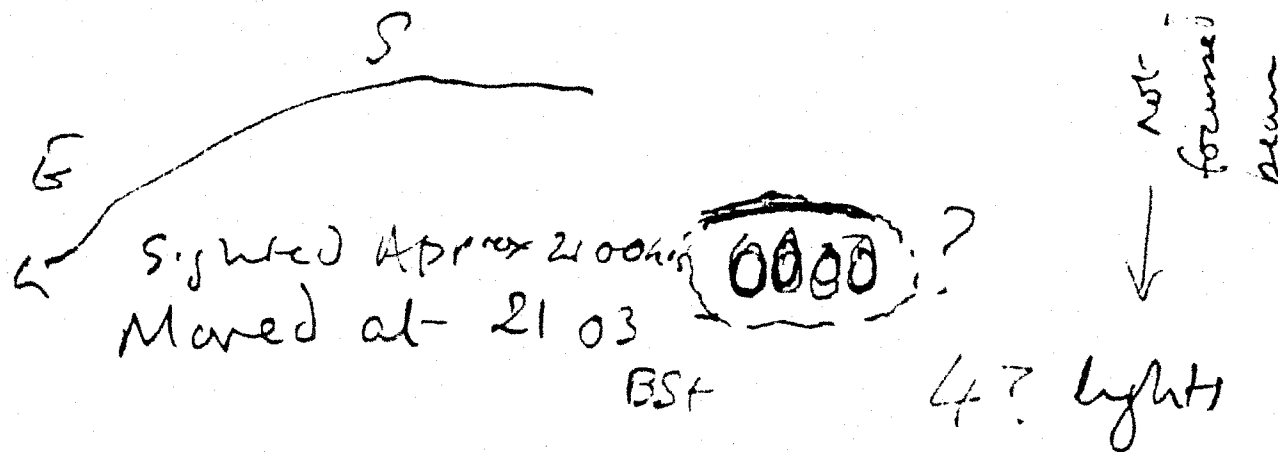

⊕ = Moon.

v. bright



74-90
90

MEMORANDUM

MOD Form 4A

To APS / Sof S

From See (As) Lea
Room Section 40
Main Bdg

Date 19th April 1990

Tel. [redacted] MB Section 40

Your ref.

Our ref. D/See (As) 12/3

Subject LETTER FROM Section 40 [redacted] DATED 1.4.90

With reference to the above letter, passed by your office to us for action on 4th April, I would like to remind you that Section 40 [redacted] has been blacklisted by See (As). A loose minute to this effect was sent on 9th Nov 1989 (copy attached.) We will not be replying to her letter.

Rank/ Appointment AS

Name in Block Letters Section 40 [redacted]

Signature Section 40 [redacted]

[REDACTED]

RECEIVED
18/11/90

MINISTRY OF DEFENCE
Sno. (4812)
18 APR 1990
FILE

17 4 90

Dear sir.

I hope you can help me. Around the 15th of October 1986. hovering lights were seen in the parbold area of Lancashire. they seemed as if they were checking something out. inquiries made in the location which may have accounted for the craft have not been successful. The local Preston observatorys estimated the star pattern for that time but no copy could be made there either

Sighting. 2 craft seen hovering too and fro on a west to east trajectory. time 8pm to 10pm. five witnesses all local people.

It seems to me that some kind of training session could be the possible cause. (ie) helicopters or Harriers. IF some kind of log book could be made I would be very pleased to hear of the result

Yours sincerely

Section 40

Note for file: 12/3

(+1) (48)

Section 40

phoned.

ve said there was increased UFO activity in Bristol area.

And that 'they' had had 2 x 1 hour communications last weeks with aliens who were going to make a massed landing in 1992.

UFOs Seen in region of Portishead Communications (Radio station on 31-37 MHz)

own
11/4

Section 40

phoned.

Said there had been a UFO sighting at Bristol airport - which had been forecast by himself and his group two days before. Sighting occurred on Saturday 14th April and was witnessed by a group of 7. Dr Henry asked whether we wanted to be informed before any appearances and I asked him to write to us.

Section 40

18/4

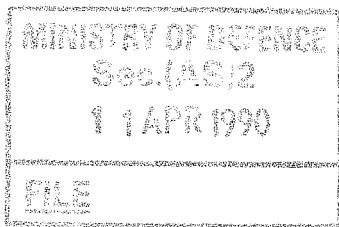

Section 40 please see if we
have any of these reports.

Section 40

nothing on file. Section 40

18/4

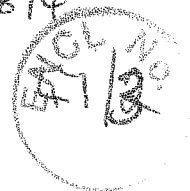

Section 40

Tel.No. Section 40

Section 40

Air Staff Secretariat 2A
Ministry of Defence
Main Building
Whitehall
London
SW1A 2HB

9th April 1990

Dear Section 40

U.F.O 's NEAR BINGHAM & R.A.F NEWTON , NOTTS.

As recently discussed I am writing to ask you if you can assist me with any details / reports made in connection with sightings reported to the R.A.F by members of the public.

The Community Affairs Officer at R.A.F Newton told me that he had forwarded some reports to his Headquarters and I hope that you can send me copies of those reports , minus name and address information of course.

Some of the sightings occurred on:-

unknown date in January 1990 (early evening)
2nd February 1990 at approx 9.45pm
3rd February 1990 at approx 6.30pm
5th February 1990 at approx 6.30pm
7th February 1990 at approx 7.15pm

If you have any reports around the same period ie January / February 1990 that you could send me I would very grateful.

Thanks , in anticipation of your help with this matter,

Yours sincerely ,

Section 40

Moved MIA to US of S 11/11
to get back.

Section 40

Ministry Of Defence,
Whitehall,
LONDON.

Section 40

be deal
accordingly -

Your ref ADG/OA/100/3342

Section 40

April 9th 1990

Section 40

Dear Section 40

11/4
Please draft
a reply, after
checking on
the quote
given in
Para 4.

Your letter of the 28th March seemsto be full of inconsistencies which leap out at me is

Section 40

1. You say that your sole involvement is to ensure that reported sightings pose no threat to our security and that you have not come across any evidence so far that they do - I am aware of a case, and I know that you are as well, when you ordered American fighter planes to shoot down a UFO in I believe 1957 - can you please explain the contradiction between this event and said comments in your letter that sightings have not been considered a security threat - I may add that I have spoken to one of the pilots personally and he told me what happened and that he was given an order to fire.

2. Following on from the above, unless you are suggesting that my Mother and I have invented our experience or that we are mad, you seem to be ignoring the stark fact that what happened to us was an infringement of UK security. We were molested on the Queens highway (The East Lancashire road) by a flying vehicle of a shape and design that we could not identify which hovered silently forty feet above our car and was able to interfere with my engine and over ride my control of the car. Added to this we lost the best part of an hour of our lives in respect of which our memories have gone - we found the experience very frightening, disturbing and frustrating at not being able to remember what happened.

How can you say, unless you are prepared to call us liars or insane, that this craft which molested two female citizens on the Queens highway and which can seemingly fly into and out of our air space unchallenged is not a threat to our security - if you do not know what the machine was and where it came from, how can you possibly know whether it is friend or foe - our impression is that it is foe and we certainly felt very threatened by it.

I would add that I have personally met eleven people who have had a similar experience - are they telling lies or are they insane?

3. You say that you make no "attemp" to investigate further or to identify what ever might have been seen unless you think they pose a threat to UK security - this is a ridiculous statement since unless you can identify what was seen how can you know whether or not it is a threat?

4. Your Section 40 said on television that your department "painstakingly and thoroughly" investigate all reported sightings and that your department are "reactive" and "responsive". This seems inconsistent with that part of your letter which says that you do not interview the originators of the reports. You say that reports are "examined" by your staff - what does this mean, and how exactly do you set about investigating a reported sighting to see if it has security implications?

check
with
office

All the people that I have spoken to who have had a similar experience felt in varying degrees, frightened of the object that they saw - as I have stated above since these flying machines seem to be able to come and go as they please and frighten people in the process - How can you say, not knowing what they are, that they do not pose a threat to the residents of this country.

It seems to me that there is something wrong with our defence system if these

craft can fly in and out as they do and that you are in breach of your duty to protect us - are we not entitled to compensation? - how do you see your duty to protect people from being frightened out of their wits by these machines?

I have a sneaking suspicion that you know more about the said machines than you are letting on and there is a government department somewhere (which may not be part of the MOD) which keeps records of reported sightings and properly deals with them in detail.

My Mother and I feel that we are being fobbed off - your letter of inconsistencies simply will not do - may I now hear from you with an early reply that does not insult our intelligence.

As far as we are concerned we were the subject of an aggressive attack by a "foreign" flying craft and that it was your duty to protect us from such craft and you failed in your duty - We were left exposed to a very frightening situation and temporarily prevented from continuing our journey. When we eventually got home we were both in shock and vomited violently, it took about a year before I could drive my car alone at night and even to this day I find the whole event very disturbing as does my Mother.

Where was our airforce and defence radar?

You have not dealt with our complaint that you have failed in your duty to protect us and as a consequence we have both suffered physically and emotionally.

In the contents of the first letter that I received from you regarding our experience, you suggested that my Mother and I should visit a Doctor, I think that I may have to take your advice as over the past year I am very concerned about certain things that are happening to me and I am convinced that these things are being caused as a direct result of the UFO experience that we suffered eight years ago.

Yours sincerely

Section 40



From:

Section 40

Secretariat (Air Staff)2a

MINISTRY OF DEFENCE

Room Section 40

Main Building Whitehall London SW1A 2HB

Telephone: (Direct Dialling) Section 40
(Switchboard)

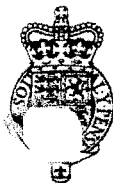
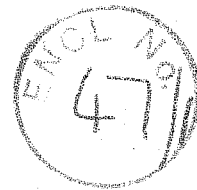

Your reference

Section 40

Our reference

D/Sec(AS)12/3

Date

6 April 1990

Dear

Section 40

Thank you for your recent letter on the subject of Unidentified Flying Objects (UFOs), in which you enclosed a tape recording for our attention.

I do not think that there is anything we can usefully add to our previous comments on the Rendlesham Forest incident. I am returning the tape recording as you requested.

With regard to your assertion that the Ministry of Defence has released small samples of reports in the past, I would like to remind you that it is possible for us to check if we have a report on a particular incident on file, and, if so, to let correspondents know what it contains. I can only assume that this was the case on the occasion to which you allude.

I hope that you will find this helpful.

Yours sincerely,

Section 40

2 APRIL 1990.

Dear Sirs,

I am writing to you with the hope that you may be able to help me. I have corresponded with you several times with regard to my interest in the subject of Unidentified Flying Objects (UFO's), you have been very helpful for which I am most grateful to you.

My reason for writing is as follows. Two MINISTRY OF DEFENCE documents I have on alleged UFO sightings contain 'distribution lists' at the bottom of the pages which show where copies of the documents would be forwarded. The distribution list on the 1st document states that copies would be forwarded to:-

- 1) AEW/GE.
- 2) AF/OPS/1/11.
- 3) DI-55.

The distribution list on the 2nd document states that copies would be forwarded to:-

- 1) ACS(P).
- 2) DD OPS GB (RAF).
- 3) DI55(B).

Could you supply a definition of the above initialled departments and what relationship they have with regard to investigating and/or analyzing alleged UFO sightings within and/or outside the United Kingdom.

Should you be able to help I would be pleased to hear from you as this is a subject I follow as a hobby. Thankyou for taking the time to read my letter it is much appreciated.

Yours Sincerely,



ENCL NO. 46/2

Head of SEC (AB) 2a

I attach a letter which the Secretary of State has received from a member of the public, and which has been acknowledged by this office.

2. I should be grateful if you would arrange for the appropriate action to be taken, including a reply as necessary. Since the Secretary of State attaches importance to such letters addressed to him being answered promptly, any reply should be sent within two weeks of the date of this minute. If, exceptionally, this should prove impossible an interim reply should be sent within the same timescale.

Section 40
[Redacted]

Pp

for APS/Secretary of State

4/1/90

Section 40
[Redacted]

NFA [Redacted] is blacklisted
Office informed 19/2.

Sec (75) 20

Rt. Hon. T. King, MP
Secretary for Defence,
Ministry of Defence,
Main Building,
Whitehall,
London SW1A 2HB.

1st. April 1990.

Dear Sir,

Enclosed you will find an article which deals with implants in the Biomedical field and includes a long list of references.

I am making a complaint to you concerning the possibility of implants on my person without my consent. How else would I be able to hear "voices" who regularly mention the Royal Air Force and members of the present government?

Who are these scientists? As the Minister for Defence you should know.

Yours faithfully,



Section 40

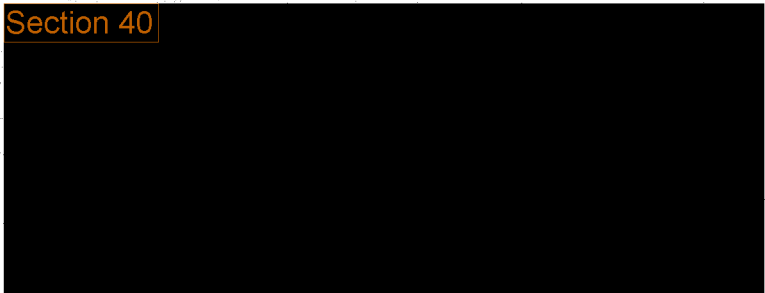

wired, or restrained animals. A large number of investigations modeling "normal" physiology or conditions of clinical importance would benefit by eliminating these restrictions. In addition, as experimental animals become more expensive and difficult to obtain, the advantages of being able to instrument an animal for several parameters and then having it available for many months of study will become increasingly valuable. Beyond all other types of medical instruments, implantable telemetry exploits fully the principal technological features—complex functional capability, high reliability, low power drain, small size, and weight—of custom monolithic integrated circuits and sensors.

The implant instruments that are aimed at clinical applications both for diagnosis and therapy are discussed in Pars. 26-21 and 26-28. A list of closed-loop control systems is given in Table 26-14 in Par. 26-55.

Biomedical Sensors and Actuators

By WEN H. KO

55. Biomedical Sensors. For biomedical electronics, both input sensors and output actuators are needed. At the input end, sensors are used to convert biomedical quantities into electric signals for the detection of body condition and behavior. At the output end, actuators are generally used to convert electrical signals into some form of stimuli of the body tissues to elicit a desired response. The physical principles, design considerations, and structure of biomedical transducers are similar to those used for other applications discussed in Sec. 10. A summary of biomedical sensors and actuators commonly used is presented in Table 26-13. Major references on conventional sensors and actuators are given in Refs. 141 to 144.

The sensor is the key to clinical measurement and diagnostic instruments. With the advance of integrated circuits and microprocessors, many measurement and instrument functions can be admirably performed by available integrated circuits or microprocessors in the field of biomedical electronics, just as they can for industrial, consumer, and aerospace applications. However, present sensors cannot match the versatility and performance of integrated circuits and microprocessors, and a need for development and research exists. Similarly, there is a need for actuators which must be fulfilled.

Many interesting biomedical systems, as shown in Fig. 26-45, are being studied and will have a strong impact on our society. Most of them need new or better transducers to make them practical for the general patient population. A summarized list of developing closed-loop-control biomedical systems and needed transducers is given in Table 26-14. By electrical stimulation of nerve or muscle, many disabled patients can regain some of their lost body functions. It has been demonstrated that "functional stimulation" can be used to (1) recover the use of a paralyzed hand, (2) allow patients in wheelchairs to stand up and walk within a controlled environment, (3) control epilepsy, and (4) control heart rate according to the body's needs, etc. Functional stimulation shows great potential in sensory aids for the deaf and blind and for control of urinary incontinence. When proper sensors are available, it is probable that an artificial pancreas for diabetes and an implant system to control hypertension will be realized.

For biomedical applications, several special requirements must be considered: (1) variations of size and weight limitations with the subjects (patients) dealt with, (2) smaller temperature range (20 to 45°C), (3) better stability and reliability for long-term experiments and patient care, (4) magnitude and range of quantities measured, which are usually small compared with those of other applications, requiring higher sensitivity, and (5) the environment in which the transducer will be used, i.e., the biocompatibility and protection of the transducer from body fluids.

With the advance of solid-state technology, many transducers have been designed with reduced size and weight specifically for medical applications.¹⁴⁵⁻¹⁴⁹ They have the potential of being used for implants for long-term study. Table 26-15 summarizes some of the solid-state transducers that were reported in the literature. Selected examples in physical and chemical areas are discussed in the following paragraphs.

56. Physical Transducers. A review on physical transducers for biomedical applications exists.¹⁴⁹ Several of the most important sensors and actuators are briefly discussed here.

TABLE 26-13 Transducers Used in Biomedical Electronic Measurements

Measured quantity	Principle or devices used	Biomedical applications
A. Physical parameters		
Electrical potential	Voltage, electrodes	Nerve and muscle activity, ECG, EEG, EMG, EOG, etc.
Impedance	Z-Bridge, electrodes	Skin condition, respiration rate, peripheral blood flow
Temperature	Thermistor, PN junction, infrared	Inflammation, cancer location, blocked circulation
Sound and vibration	Microphones, variable Z	Heart and breathing sounds, blood-pressure measurement, fluid flow
Light	Transmission, refraction, absorption, LED, detectors	Physiology research, clinical laboratory, gas and ion sensors
Magnetic	Permeability, field	Blood flow, heart activity, proximity
Force and pressure	Piezoresistance, capacitance, deformation	Pressure of blood, CSF, urine, etc., locomotion
Displacement, velocity, acceleration	Capacitive, magnetic, laser, ultrasonic, optical, ultrasound, acceleration force	Body movement, physiology research, orthopedics
Flow (blood, fluid, air)	Electromagnetic, optical and ultrasonic Doppler, pressure drop, streaming potential	Blood, air, body fluid flow, heart, lung, kidney functions
Volume	Displaced volume, dye dilution	Physiology research, cardiac output
Imaging (shape, surface, 3-D structure)	X-ray, ultrasound, microwave, nuclear isotope	Shape and motion of the organs: heart, brain, eye, teeth, etc.
Time	Delay, response time	Alertness, nerve signal transmission, signal transmission in heart and other organs
B. Chemical parameters		
Gas concentration	Gas-sensitive electrodes, chromatography, chemical analysis	Blood gas (H^+ , O_2 , CO_2 , O_2 saturation) respiration, perfusion, anesthesia, hospital operations, clinical laboratory
Humidity	Dew point temperature, resistance and capacitance, change due to condensation or absorption	Pediatric, respiratory research, intensive care
Ions	Ion selective electrodes ISFET, chemical analysis	Clinical laboratory, intensive-care unit, acid-base balance
Biomolecules	Enzyme electrodes, chemical analysis	Clinical laboratory, research laboratory, patient monitoring
C. Behavior parameters		
New sensors to be developed (in addition to those listed in A and B)		

(a) *Electrodes.* Electrodes are used to sense voltage, current, and impedance and to deliver stimulating currents to nerves or muscles to activate the desired body response. The main problems to be overcome in the development of sensing electrodes are the electrode-tissue interface stability, the corrosion and body reaction to electrodes, and the noise pickup. Metal electrodes, especially the Ag-AgCl electrode and the Pt-PtIr electrode, have been used extensively in health care. Microelectrodes with tips of around 1- μ m diameter are used for cellular-level sensing. They are traditionally made of glass tubes filled with electrolytes or metals such as tungsten. Silicon technology has been used to fabricate microelectrodes and arrays of electrodes for neurophysiological studies.¹⁵⁰ Source followers and amplifiers were integrated with the electrode tip to provide

high input impedance and low output impedance such that the environmental noise problem could be avoided. An insulated electrode was developed that has a layer of stable oxide insulation

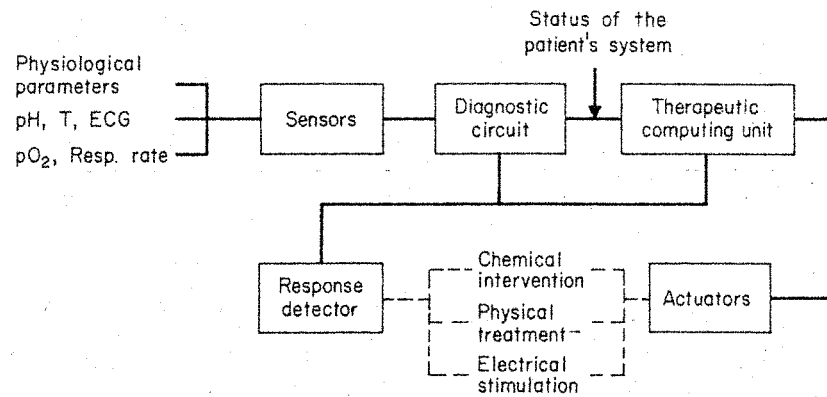

Fig. 26-45. Closed-loop medical systems.

covering the metal or other conductor surface of the electrode. The signal is picked up by the charging and discharging of the capacitor or the insulating layer.¹⁵¹ The insulated electrode using a TA_2O_3 , TiO_2 , or Si_2N_3 surface has achieved good stability and can be used as both a sensing and stimulating device. In order to alleviate the electrode-electrolyte interface problem, a scheme of microelectrode arrays is being investigated where a micropocket is formed surrounding the metal electrode and is then filled with a high-conductivity electrolyte. The pocket has an opening to interface with body electrolytes, and the opening serves as the effective electrode surface. Elec-

TABLE 26-14 Closed-Loop-Control Medical Systems

A. Therapeutic systems		
Disease	Treatment	Sensors required
Cardiac arrhythmia	Physiologic pacemakers	Pressure, flow, pH, PO_2 , PCO_2
Paraplegia and quadriplegia	Control of limbs with nerve bypass system	Electrodes, position, touch, and angle
Sensory aids	Implantable hearing and visual aids	Sensors, microphone, and stimulators
Respiratory apnea	Diaphragm or nerve pacing	Pressure, flow, PCO_2 and stimulator
Urinary incontinence	Bladder control system	Pressure and control valve
Hypertension	Automatic blood-pressure control	Blood pressure, stimulator
Epilepsy	Cerebellar stimulation	EEG sensors and stimulators
Hydrocephalus	ICP and ventricular size control	Pressure, volume, control valves
Diabetes	Automatic insulin infusion pump	Glucose sensor and controlled pump
Psychological systems	Drug-release systems and electrical stimulation	Various sensors
B. Artificial organs		
Organs	Hardware system	Sensors required
Artificial heart	Blood pump and control	Pressure, flow, PO_2 and PCO_2
Artificial pancreas	Insulin perfusion system	Flow, pressure, and glucose sensor
Artificial kidney	Dialysis machine	Uric acid, flow, and pressure
Artificial larynx	Body-controlled oscillators	EMG sensors and actuators
C. Drug delivery systems		
Disease	Treatment	Sensors required
Pain, cancer, and others	Drug pump	Drug-level sensor and actuators

tronics can be integrated on the substrate of these microelectrode arrays to improve the signal quality. Figure 26-46 illustrates the evolution of the electrodes.¹⁴⁹ Large numbers of electrodes¹⁸⁷ have been used to map the potential distribution on the body surface.¹⁹⁵

Microelectrode arrays have also been fabricated to correlate signals from neurons at different depths of the brain.¹⁹⁶ For stimulation, metal electrodes are used; the leads are coiled to provide flexibility and to avoid fatigue. The stimulating charge per pulse per unit area of the Pt electrode

TABLE 26-15 Solid-State Transducers

Parameters measured	Principles used	References
Electrical potential and impedance	Active electrodes with amplifier	149
	Microelectrode	150
Temperature and infrared radiation	Junction diode with IC	151
	Bulk barrier diode	152
	Thermopiles on Si	153
	ZnO on MOSFET amplifier	154
Sound and ultrasound	PVF ₂ with FET amplifier	155
	ZnO integrated into gate of MOSFET	156
Light	LED and diode lasers	
	CCD and photodetectors	
Magnetic field	Multicollector transistor	157
	Carrier domain movement	158
	Magnetoresistance	145
Fluid flow	"Hot wire anemometer" with IC	159
	Double-bridge detector	160
	Pyroelectric detector	161
Two-dimensional position	Light spot position-sensitive photodetectors on Si or on GaAs	162-164
	Deformation of Si diaphragm by or piezoresistance changes with IC	165, 166
Pressure	Resonant diaphragm with ZnO on Si in the feedback loop	167-169
		170
Acceleration	Inertia force on micromachined cantilever beams, on Si with IC, or on GaAs	171
		172, 174
Force	<i>PN</i> junction stress effects	175
		176
Actuators	Piezoelectric wafer-operated ink jets	176
	Electrostatic shutter display	177
	Electrostatic force on skin	178
	Charge-flow transistor	179
Moisture, humidity	Oxide films	146, 180
		146, 182
Gas concentration	MOSFET with Pd or Pt gate	145, 146, 183
Chemical species in air	Si wafer gas chromatograph	147, 184, 185
	Oxide films, potentiometric	186, 187
Ionic concentration in electrolytes	Ion-sensitive diode	188, 189, 190
	Ion-sensitive FET	145, 146, 191
Chemical ions and molecules, solution	Chemically sensitive FET	192, 193
	Optical absorbing of fluorescent indicators	

has to be limited to 30 μC per cm^2 per pulse, to avoid surface corrosion and pH change near the electrode that might damage the tissue nearby. Insulated electrodes and pocket electrodes are being investigated as stimulating electrodes. The major problems are (1) corrosion of the electrode and biocompatibility, (2) the breakage of the electrode when implanted, and (3) the relative motion between the electrode and the tissue.

(b) *Temperature.* Body and environmental temperatures are measured with thermal resistive devices—thermistors; thermoelectrical devices—thermocouples; *pn* junction diodes; temperature-sensitive resonant circuits; infrared radiation, chemical devices—liquid crystals; and others. Most of these principles can be applied to solid-state sensors fabricated on semiconductor substrates.

PN junction temperature sensors are now commercially available. For normal junction diodes with a constant current flowing through them, the *pn* junction voltage decreases about 2 to 3 mV/ $^{\circ}\text{C}$ as the temperature rises. Junction sensors with IC interfaces can give direct voltage readings

corresponding to temperature in degrees Fahrenheit or Celsius at the output.¹⁵² The sensitivity of special junction devices can be $-1.2 \text{ V}/^\circ\text{C}$ or -10% per degree Celsius, which is comparable to thermistors in sensitivity.¹⁵³ Microstructured thermopile infrared detectors have been fabricated on silicon substrates for noncontact temperature measurement or IFR detection with a responsiveness of $6 \text{ V}/\text{W}$ and a time constant of 15 ms .¹⁵⁴

A *pn* junction array was made to measure the temperature profile of the body.¹⁹⁷ The change of the energy band gap with temperature in semiconductor materials can be measured by the

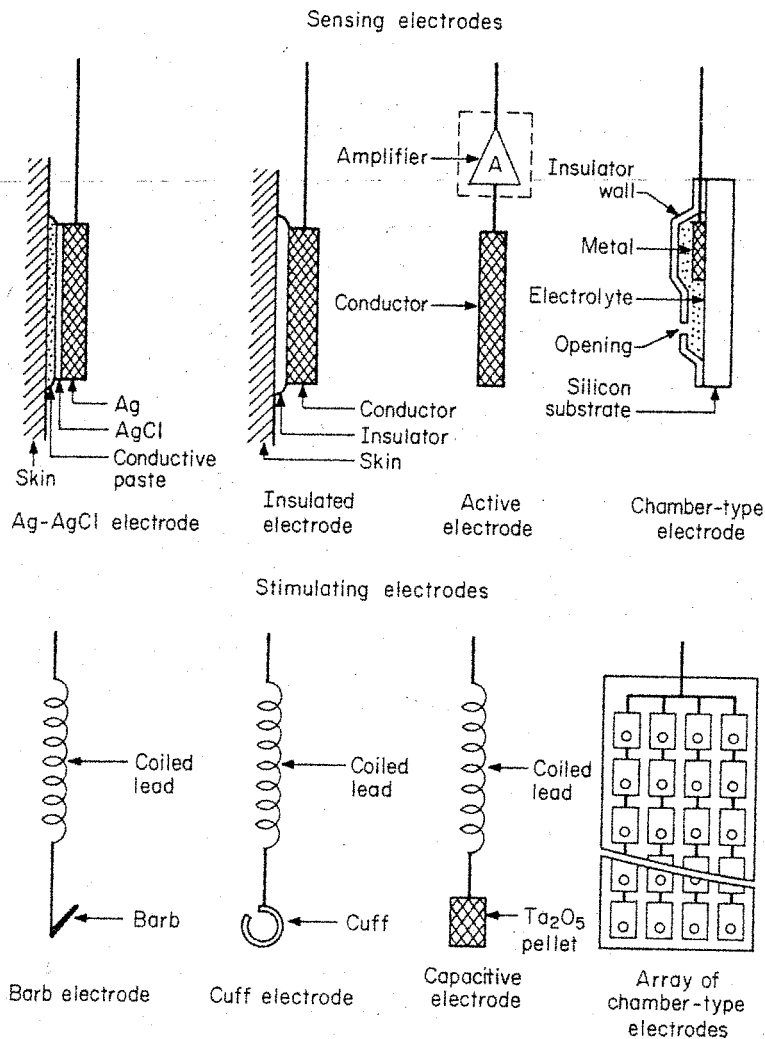

Fig. 26-46. Types of electrodes.

optical absorption spectrum edge. When incorporated with fiber optics, it provides a means of measuring body temperature with nonconductive devices. Liquid crystals or other materials that change their absorption characteristics with temperature can also be used with optical fiber to provide a nonconductive method for determining localized temperature.

(c) *Position and Motion.* Position and displacement are measured with potentiometric devices, strain gages, linear voltage differential transformers, capacitive displacement devices, and ultrasonic devices. Velocity is measured with ultrasonic or optical Doppler effects, electromagnetic devices, and integration of acceleration or differentiation of displacement. Acceleration is measured by a mass and its acceleration force. A two-dimensional position detector in the form of a 6- to 8-mm rectangular chip of silicon crystal that can determine the two-dimensional coordinates of a light spot projected on the surface of the device with good linearity was reported.^{163,164} Figure 26-47 illustrates that the displacement or position of a refracting surface can be accurately measured by optical reflection. An analog signal can be obtained at the output with the accuracy of a few microns. The device was used to measure the motion of a tympanic membrane. It can

be used for measuring small deformation of stressed elements used in load cells and others. A silicon chip mass and spring accelerometer, $2 \times 3 \times 0.6$ mm in size, weighing less than 0.02 g, was reported having a frequency response of 1,000 Hz.^{182,183} Several designs using piezoelectric films were reported to sense the inertia force.^{145,148} These devices can be used for biological and physiological prostheses and sensory aids.

Figure 26-48 shows the principle and structure of a capacitive sensor used to measure the joint angle that can provide needed feedback signals for computer-controlled walking.^{198,199} It can be

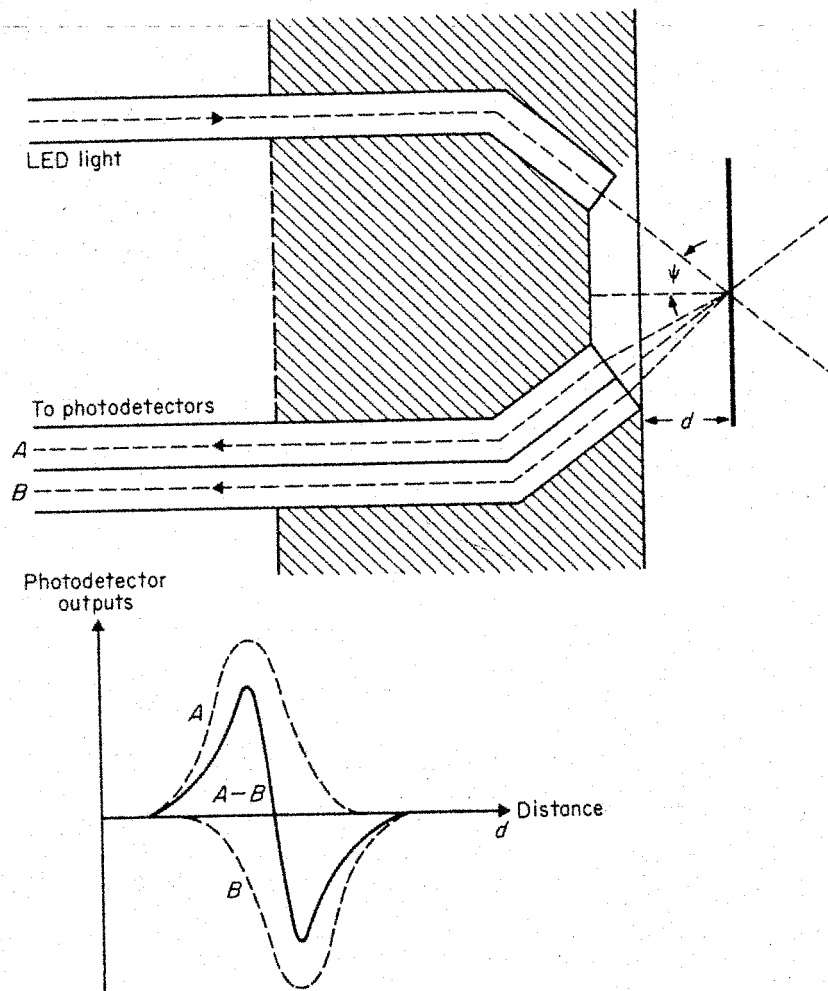

Fig. 26-47. Principle of optical position detector.

integrated onto a silicon substrate. These devices are being used in research projects to provide feedback information for computer-controlled prostheses.

(d) *Pressure.* Various indirect methods are used to measure body fluid pressures, such as the cuff method for measuring blood pressure and the force balance method used in tonometry. Direct methods include measuring mechanical deformation of tubes and diaphragms and using piezoresistive, capacitive, and optical methods to convert mechanical deformation of metal, glass, and silicon diaphragms into electrical signals representing pressure. For biomedical applications, piezoresistivity has been used to fabricate miniature force and pressure transducers. Silicon diaphragm piezoresistive devices for both gage and absolute pressure were fabricated and are now commercially available. Not only is the size small (on the order of 1 mm^3), but the long-term base-line stability of 0.1 to 0.3% per month was observed.²⁰⁰ The problem of packaging this device to protect it from body fluid seepage and the resultant bias drift needs further investigation, although implant devices in animals have achieved similar stability over 11 months.²⁰¹ The techniques developed in the heart pacemaker industry are being adopted for the packaging of

transduc
ing circu
itance br
optical r
deflectic

Fig

transducers. Several miniature silicon capacitive pressure transducers with some signal-processing circuits integrated on the chip were reported.¹⁶⁷⁻¹⁷⁰ A design with a bipolar oscillator, capacitance bridge, and follower circuits integrated on the capacitor chip is shown in Fig. 26-49.¹⁰² The optical reflection technique described above in part (c) has also been used to convert diaphragm deflection caused by pressure changes into an electrical signal.

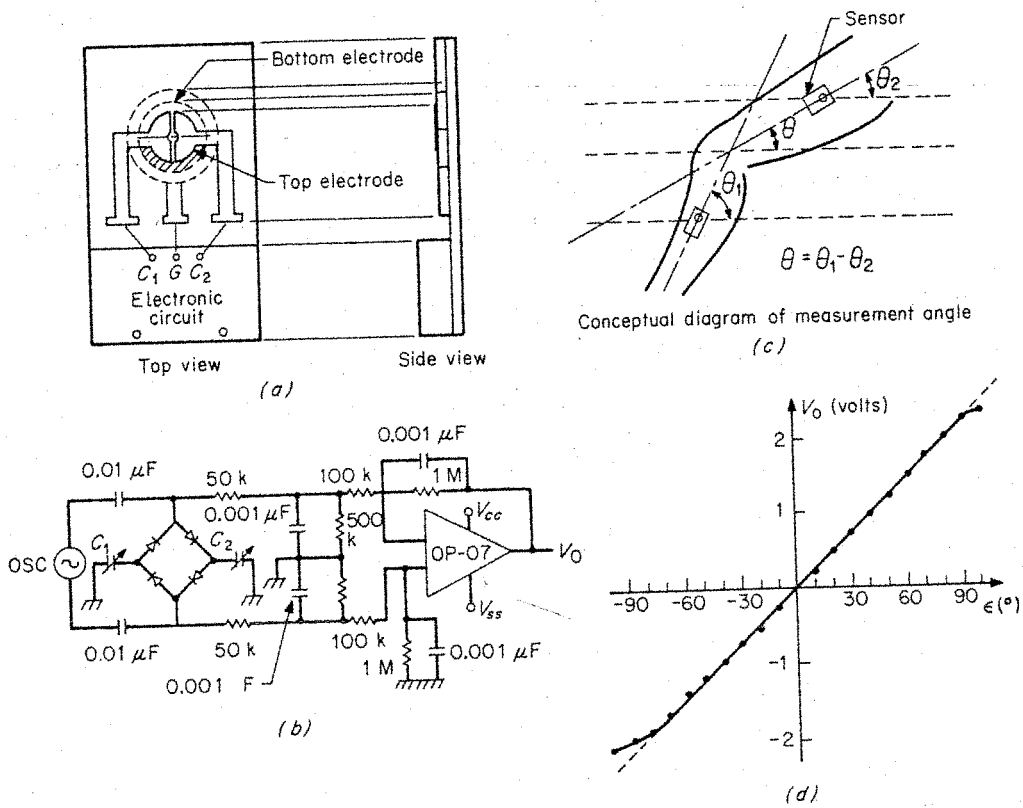

Fig. 26-48. The principle and structure of a joint angle sensor: (a) structure, (b) circuit, (c) principle, (d) results.

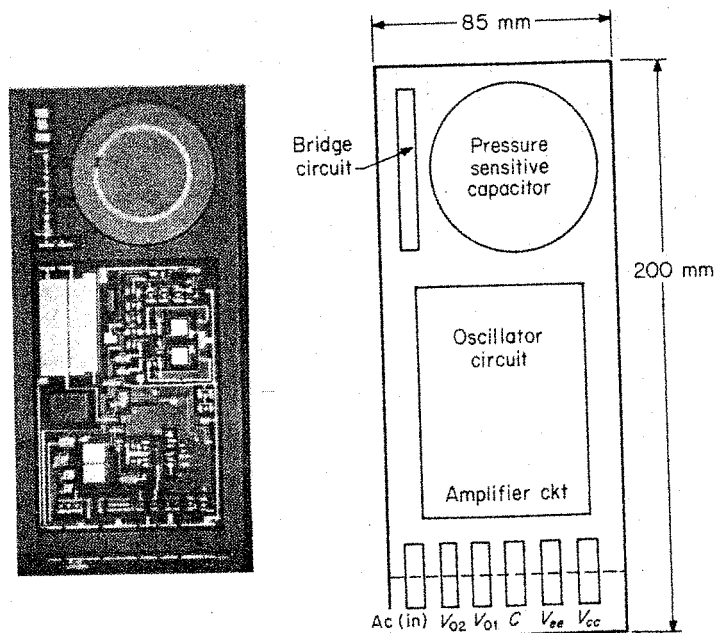

Fig. 26-49. A silicon capacitive pressure transducer with a bipolar signal-processing circuit on the chip.

others. A
an 0.02 g,
zoelectric
ogical and

the joint
It can be

to provide
such as the
tonometry,
and using
of metal
medical appli-
ducers. Sil-
icated and
at the long-
kaging this
r investiga-
ths. The
ackaging of

(e) *Flow.* Blood flow has been measured with electromagnetic devices, ultrasonic and optical Doppler devices using solid-state transducers and fiber optics, plethysmography, pressure gradient, and rapidly injected indicator dilution methods.¹⁴¹ There are many review articles and textbooks which discuss the established ultrasonic, electromagnetic, and dilution techniques for flow measurement.¹⁴¹⁻¹⁴³ Therefore, they are not discussed here. A thermal transport device fabricated on a silicon chip was reported which measures the temperature differences at the up and down streams of a heat source, referring back to the flow velocity.¹⁶⁰ Integrated circuits can be fabricated on the flow-sensor chip to perform simple processing functions.¹⁶¹

(f) *Humidity Sensor.* Humidity is an important parameter in health care, especially in respiratory therapy and packaging of implant systems. It can be measured by the change in (1) impedance of plastic material absorbing water vapor, (2) the surface impedance (resistance and capacitance) of insulators, such as Al_2O_3 , with closely spaced electrodes, and (3) the dew point when the sensor temperature is lowered. One solid-state humidity sensor uses a silicon chip on top of the Peltier cooling element. The chip contains two interdigitated electrode structures form-

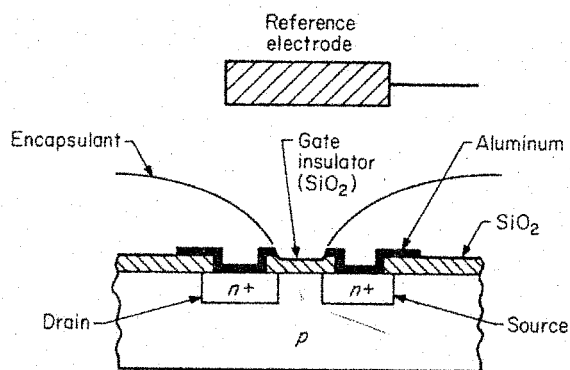

Fig. 26-50. Structure of silicon-dioxide-gate ISFET.

ing a capacitor. As the temperature is lowered, water vapor starts to condense on the structure, drastically changing its capacitance because of the large dielectric constant of water.¹⁸¹ Other designs utilize porous oxide layers sandwiched between a base metal and a top electrode.¹⁴⁷ The charge-flow-transistor oscillator also offers an interesting alternative as a humidity sensor.¹⁸⁰

(g) *Solid-State Actuators.* Solid-state microstructure research is just beginning. The existing actuator designs include cantilever beams, ink jets,¹⁷⁷ display,¹⁷⁸ and capacitive imaging devices that control touch sensation with electric potential using skin as a plate of the capacitor.¹⁷⁹ These principles and techniques can be used to design drug pumps and flow-control devices.

Other types of actuators that can be controlled by low-power electrical signals to regulate the flow or position and generate some pumping action are needed for implant prostheses. Work on implantable or indwelling drug pumps has been reported in the literature.¹⁴⁹⁻²⁰³

57. Chemical Sensors. In the chemical transducer area, the solid-state sensors have had development in the following areas.

(a) *Blood Gas and Electrolyte Concentration Sensors.* Ion-sensitive field-effect transistors, ISFETs, are shown in Fig. 26-50, with the gate insulator exposed to the electrolyte to measure ionic concentration in body electrolytes.^{188,189} Concentrations such as pH, K^+ , Na^+ , Ca^{++} , Mg^{++} , Cl^- , and F^- can be measured with various modified insulators by adding a membrane to the gate insulator.^{145,147} Thin- and thick-film sensors for PO_2 , PCO_2 , and other gas and ionic species in solution are also being developed using silicon substrates and photolithography. Multiple sensors and reference electrodes can be integrated on the chip with the exposed area on the order of $10 \mu\text{m}^2$, thus alleviating many problems due to flow and protein deposition.^{190,204} Fiber optics have been used for oxygen saturation measurement in blood. Improvement in signal analysis and sensor design should lead to the development of on-line catheter-type monitoring devices.^{205,206}

(b) *Gas Sensors.* Hydrogen gas can be monitored with Pd or Pt gate MOSFET.^{182,183} The hydrogen permeates through the metal gate into the metal insulator interface producing a change in the threshold voltage of the FET. At 150°C , 10 ppm of H_2 can be detected. Other reducing and oxidizing gases can be monitored by the impedance of SnO_2 , ZnO , TiO_2 , and other oxide sur-

faces.
already
the ch
be de
on the
26-51

faces.¹⁴⁷ The combustive gas monitor used in gas-heated homes and in various laboratories already has a sizable commercial market. Humidity can be measured by the dew point and by the change of capacitance and resistance of an interdigitated electrode structure. These oxides can be deposited on silicon substrates and then modified with various catalytic materials deposited on the surface to sense various gases with improved sensitivity and selectivity, as shown in Fig. 26-51. A gas chromatographic air analyzer was fabricated on a silicon wafer using solid-state

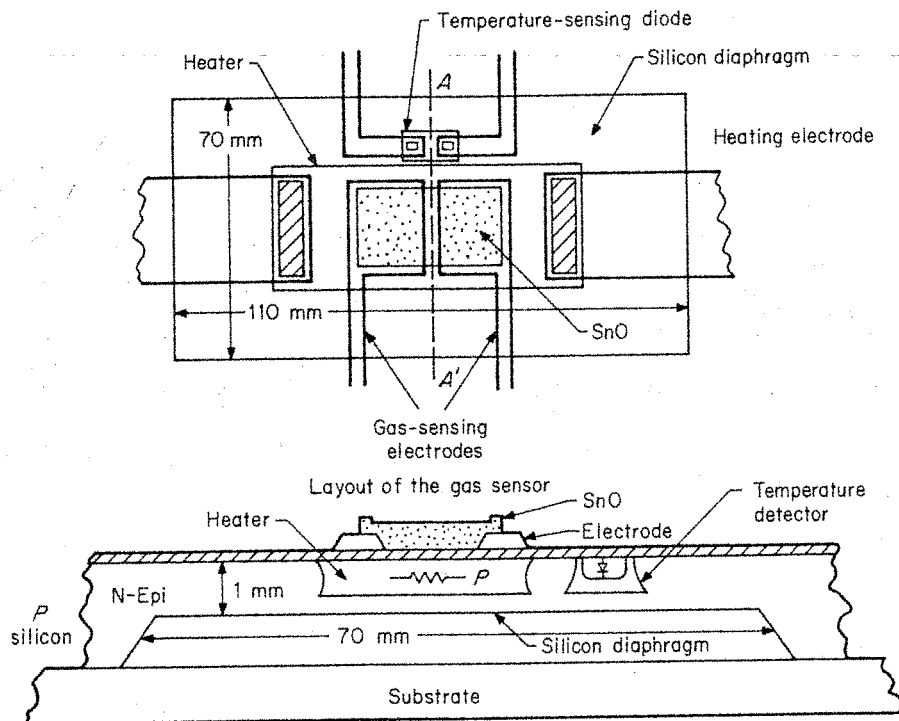

Fig. 26-51. Structure of a silicon substrate gas sensor.

electronic techniques.¹⁸⁴ Similar techniques can be used to design and fabricate gas sensors that measure the change in mass and thermodynamic properties when gas molecules are deposited on the sensor surface.

(c) *Enzyme, Protein, and Molecular Sensors.* By enclosing, trapping, or absorbing enzymes on substrate materials on the surface of chemical sensors, the product of the enzymatic reaction can be sensed as a means of detecting the presence of enzymes on the substrate.²⁰⁷⁻²⁰⁹ Similar techniques can be used for body-protein detection and the measurement of other molecular substances in biomedical research and health care. The possibility for on-line determination of proteins will greatly improve health care and advance our understanding of living systems. The stability and the packaging are, at present, the major problems encountered with these types of sensors.

The future of adopting solid-state electronic technology and micromachining methods for new and improved chemical sensors is believed to be vast and is dependent only on the creative approaches taken and the care taken in the implementation of the concepts.

58. Bibliography and References

General References

1. Cromwell, L., et al. "Medical Instrumentation for Health Care," Prentice-Hall, Englewood Cliffs, N.J., 1976.
2. Webster, J. G. (ed.) "Medical Instrumentation: Application and Design," Houghton Mifflin, Boston, 1978.
3. Welkowitz, W. and S. Deutsch "Biomedical Instruments: Theory and Design," Academic, New York, 1976.

4. *IEEE Transactions on Biomedical Engineering: Biomedical Engineering Journal*, Culver City, Calif., *Journal of American Association of Medical Instrumentation; BioMedical Engineering*, United Trade Press, London; *Biomedical Engineering (Transactions of Meditsinskaya Tekhnika); Proceedings of Annual Conference of Engineering in Medicine and Biology* (since 1959).
5. *Biophysics, Bioengineering and Medical Instrumentation*, International Medical Abstracting Service, sec. 27, *Excerpta Medica*, Amsterdam; *Medical Electronics and Communications Abstract*, MultiScience Publishing Company, Essex, England; *Index Medicus*, U.S. Dept. of H.E.W., Public Health Service, National Library of Medicine (monthly).
6. Dummer, G. W. A., and J. M. Robertson (eds.) "Medical Electronic Equipment," Pergamon, New York, 1970.
7. Weyer, E. M. (ed.) Materials in Biomedical Engineering, *Ann. N.Y. Acad. Sci.*, 1968, Vol. 146, Part 1.
8. Levine, S. N. (ed.) *J. Biomed. Mater. Res.*, March 1967.

Biomedical Electronics

9. ANSI Safety Level of Electromagnetic Radiation with Respect to Personnel, ANSI C95.1-1974, IEEE, New York, 1974.
10. Neukomm, P. A. Health Hazards from Telemetry RF Exposure, in Fryer, Miller, and Sandler (eds.), "Biotelemetry III," pp. 41-44, Academic, New York, 1976.
11. Schwan, H. P. Microwave Radiation: Biophysical Considerations and Standards Criteria, *IEEE Trans. Biomed. Eng.*, 1972, Vol. BME 19, p. 304.
12. Gandhi, O. P. State of the Knowledge for Electromagnetic Absorbed Dose in Man and Animals, *Proc. IEEE*, January 1980, Vol. 68, No. 1, pp. 24-32.
13. Special Issue on Biological Effects and Medical Applications of Electromagnetic Energy, *Proc. IEEE*, January 1980, Vol. 68, No. 1.
14. Rostoker, W., and J. O. Galante Materials for Human Implantation, *Trans. ASME*, February 1979, Vol. 101, pp. 2-14.
15. Fraker, A. C., and A. W. Ruff Metallic Surgical Implants: State of the Art, *J. Metals*, May 1977, pp. 22-28.
16. Boretos, J. W. "Concise Guide to Biomedical Polymers," Thomas, Springfield, Ill., 1973.
17. Lefaux, R. "Toxicology of Plastics," CRC Press, Boca Raton, Fla., 1968.
18. Rushmer, R. F. Future Horizons for Technology in Health Care Delivery, *Adv. Biomed. Eng.*, 1976, Vol. 6, pp. 99-153.

Electrocardiography, Biopotentials, and Patient Safety

19. Hoffman, I. (ed.) "Vectorcardiography," Vol. 2, North-Holland, Amsterdam, 1971.
20. Pozzi, L. "Basic Principles in Vector Electrocardiography," Thomas, Springfield, Ill., 1961.
21. Plonsey, R. "Bioelectric Phenomena," McGraw-Hill, New York, 1969.
22. Geselowitz, D. B., and O. H. Schmitt Electrocardiography, in H. P. Schwan (ed.), "Biological Engineering," McGraw-Hill, New York, 1969.
23. McFee, R., and G. M. Baule Research in Electrocardiography and Magnetocardiography, *Proc. IEEE*, 1972, Vol. 60, pp. 290-321.
24. Kossmann, C. E. (chairman) Recommendations for Standardization of Leads and of Specifications for Instruments in Electrocardiography and Vectorcardiography, *Circulation*, 1967, Vol. 35, pp. 583-602.
25. Hurst, J. W., and R. B. Logue (eds.) "The Heart," McGraw-Hill, New York, 1970.
26. Walter, C. W. (ed.) "Electric Hazards in Hospitals," National Academy of Sciences, Washington, 1970.
27. Geddes, L. A., and L. E. Baker "Principles of Applied Biomedical Instrumentation," Wiley, New York, 1968.
28. Brazier, M. "The Electrical Activity of the Nervous System," Macmillan, New York, 1958.
29. Donchin, E., and D. B. Lindsley (eds.) "Average Evoked Potentials," NASA, Washington, 1969.
30. Pinelli, P. (ed.) "Progress in Electromyography," Elsevier, Amsterdam, 1962.
31. Wulfsohn, N. L., and A. Sances, Jr. "The Nervous System and Electric Currents," Plenum, New York, 1970.

Radiology

32. Glasser, O., et al. "Physical Foundations of Radiology," 2d ed., Hoeber, New York, 1952.
33. Evans, R. D. "The Atomic Nucleus," McGraw-Hill, New York, 1956.
34. Johns, H. E., and J. S. Laughlin Interaction of Radiation with Matter, Chap. 2 in Hine and Brownell (eds.), "Radiation Dose Symmetry," Academic, New York, 1956.
35. Heitler, W. "Quantum Theory of Radiation," 3d ed., Oxford University Press, Fair Lawn, N.J., 1954.
36. Johns, H. E. "The Physics of Radiology," 3d ed., Charles C. Thomas, Springfield, Ill., 1969.
37. Glasser, O., E. H. Quimby, L. S. Taylor, and J. L. Weatherwax "Physical Foundations of Radiology," Hoeber, New York, 1954.
38. Hine, G., and G. Brownell "Radiation Dosimetry," Academic, New York, 1956.
- 38a. Bender, M. A. The Autofluoroscope, in Bland (ed.), "Nuclear Medicine," 2d ed., McGraw-Hill, New York, 1971.
- 38b. Anger, H. O. Gamma Ray and Positron Scintillation Camera, *Nucleonics*, 1963, Vol. 21, p. 56.

39. Wa
39a. T
T
4
40. Bl
41. Ma
42. G
Pl
43. E
L

Art

44.

45.

46.

47.

48.

49.

50.

M

A

51.

52.

53.

54.

55.

56.

57.

58.

59.

39. Wagner, H. B. "Principles of Nuclear Medicine," Saunders, Philadelphia, 1968.
- 39a. Ter-Pogossian, M. A., N. A. Mullani, J. Hood et al. A Multiposition Positron Emission Computed Tomograph (PETT IV) Yielding Transverse and Longitudinal Images, *Radiology*, 1978, Vol. 128, pp. 477-484.
40. Blahd, W. H. "Nuclear Medicine," 2d ed., McGraw-Hill, New York, 1971.
41. Maynard, D. C. (ed.) "Clinical Nuclear Medicine," Lea & Febiger, Philadelphia, 1969.
42. Gross, W., S. Feitelberg, and E. H. Quimby "Radioactive Nuclides in Medicine and Biology: Basic Physics and Instrumentation," 3d ed., Lea & Febiger, Philadelphia, 1970.
43. Early, P. J., M. A. Razzak, and D. B. Sodee "Textbook of Nuclear Medicine Technology," Mosby, St. Louis, 1969.

Artificial Organs

44. *Artificial Organs*, official journal of the International Society for Artificial Organs.
45. *Transactions of the American Society of Artificial Organs*.
46. Nose, Y. "Manual on Artificial Organs," Vol. 1 "The Artificial Kidney," Mosby, St. Louis, 1969.
47. Nose, Y. "Manual on Artificial Organs," Vol. 2, "The Oxygenator," Mosby, St. Louis, 1973.
48. *Devices Technol. Branch Contract. Meet. Proc.*, National Heart, Lung, and Blood Institute, Div. of Heart and Vascular Diseases.
49. Galletti, P. M., and G. A. Brecher "Heart-Lung Bypass," Grune & Stratton, New York, 1962.
50. *11th Annu. Contract. Conf. Artif. Kidney Program NIAMDD Proc.*, January 1978, DHEW Publication (NIH) 79-1442.

Myoelectric Control and Functional Stimulation

Myoelectric Control

51. Katz, B. "Nerve, Muscle, and Synapse," McGraw-Hill, New York, 1966.
52. Ruch, T. C., and H. D. Patton "Physiology and Biophysics," Saunders, Philadelphia, 1971.
53. Stalberg, E., and J. Trontelj "Single Fibre Electromyography," Mirvalle, 1979.
54. Basmajian, J. "Muscles Alive," Williams & Wilkins, Baltimore, 1967.
55. Scott, R. N., P. A. Parker, and V. A. Dunfield Myoelectric Control, *IEEE Med. Electron. Monogr.* 7-12, 1974.
56. Agarwal, G., and G. Gottlieb An Analysis of the Electromyogram by Fourier, Simulation and Experimental Techniques, *IEEE Trans. Biomed. Eng.*, 1975, Vol. 22, No. 3, pp. 225-229.
57. Bergey, G., R. Squires, and W. Sipple Electrocardiogram Recording with Pasteless Electrodes, *IEEE Trans. Biomed. Eng.*, 1971, Vol. 18, pp. 206-211.
58. Roesler, H. Statistical Analysis and Evaluation of Myoelectric Signals for Proportional Control, in Herberts et al. (eds.), "The Control of Upper-Extremity Prostheses and Orthoses," pp. 44-57, Thomas, Springfield, Ill., 1974.
59. Bouisset, S. EMG and Muscle Force in Normal Motor Activities, in Desmedt (ed.), "New Developments in Electromyography and Clinical Neurophysiology," Vol. 1, pp. 547-583, Karger, Basel, 1973.
60. Kreifeldt, J., and S. Yao A Signal-to-Noise Investigation of Nonlinear Electromyographic Processors, *IEEE Trans. Biomed. Eng.*, 1974, Vol. 21, No. 4, pp. 298-308.
61. Childress, D., D. Holmes, and J. Billock Ideas on Myoelectric Prosthetic Systems for Upper-Extremity Amputees, in Herberts et al. (eds.), "The Control of Upper-Extremity Prostheses and Orthoses," pp. 86-106, Thomas, Springfield, Ill., 1974.
62. Childress, D. Powered Limb Prostheses: Their Clinical Significance, *IEEE Trans. Biomed. Eng.*, 1973, Vol. 20, No. 3, pp. 200-207.
63. Dorcas, D., and R. Scott A Three-State Myoelectric Control, *Med. Biol. Eng.*, 1966, Vol. 4, pp. 367-370.
64. Childress, D. A Myoelectric Three-State Controller Using Rate Sensitivity, *Proc. 8th Intl. Conf. Med. Biol. Eng.*, 1969, pp. 4-5.
65. Herberts, P., C. Alstrom, R. Kadefors, and P. Lawrence Hand Prosthesis Control via Myoelectric Patterns, *Acta Orthop. Scand.*, 1973, Vol. 44, pp. 389-409.
66. Wirta, R., D. Taylor, and R. Finley Pattern Recognition Arm Prosthesis: A Historical Perspective—A Final Report, *Bull. Prosthet. Res.*, (B.P.R. 10-30) 1978, pp. 8-35.
67. Jacobsen, S., and R. Jerard Laboratory Evaluation of a Unified Theory for Simultaneous Multiple Axis Artificial Arm Control, *ASME Publ.* 79-WA/Bio-8, December 1979.
68. Graupe, D., J. Magnussen, and A. Beex A Microprocessor System for Multifunctional Control of Upper-Limb Prostheses via Myoelectric Signal Identification, *IEEE Trans. Autom. Control*, 1978, Vol. AC23, 4, pp. 538-544.

Functional Stimulation

69. Brindley, G. S., and W. S. Lewin The Sensations Produced by Electrical Stimulation of the Visual Cortex, *J. Physiol.*, 1968, Vol. 106, pp. 479-493.
70. Dobelle, W. H., S. S. Stensaas, M. G. Mladejovsky, and J. B. Smith A Prosthesis for the Deaf Based on Cortical Stimulation, *Ann. Otol., Rhinol. Laryngol.*, 1973, Vol. 82, pp. 445-464.

71. Peckham, P. H., and J. T. Mortimer Restoration of Hand Function in the Quadriplegic through Electrical Stimulation, pp. 83-95, in Hambrecht and Reswick (eds.), "Functional Electrical Stimulation, Applications in Neural Prostheses," Dekker, New York, 1977.
72. Mortimer, J. T. Motor Prostheses, Chap 39 in Brooks (ed.), "APS Handbook and Motor Control," American Physiological Society, in press.
73. McHardy, J., D. Geller, and S. B. Brummer An Approach to Corrosion Control During Electrical Stimulation, *Ann. Biomed. Eng.*, 1977, Vol. 5, pp. 144-149.
74. Pudenz, R. H., L. A. Bullara, D. Dru, and A. Talalla Electrical Stimulation of the Brain, II: Effects on the Blood Brain Barrier, *Surg. Neurol.*, 1975, Vol. 4, pp. 265-270.
75. Brummer, S., and M. J. Turner Electrical Stimulation with Pt Electrodes, I: A Method for Determination of "Real" Electrode Areas, *IEEE Trans. Biomed. Eng.*, 1977, Vol. BME 25, No. 5, pp. 436-439.
76. Guyton, D. L., and F. T. Hambrecht Capacitor Electrode Stimulates Nerve or Muscle Without Oxidation-Reduction Reactions, *Science*, July 6, 1973, Vol. 181, pp. 74-76.
77. Guyton, D. L., and F. T. Hambrecht Theory and Design of Capacitor Electrodes for Chronic Stimulation, *Med. Biol. Eng.*, September 1974, pp. 613-620.
78. Bernstein, J. J., L. L. Hench, P. F. Johnson, W. W. Dawson, and G. Hunter Electrical Stimulation of the Cortex with Tantalum Pentoxide Capacitive Electrodes, pp. 465-477, in Hambrecht and Reswick (eds.), "Functional Electrical Stimulation, Applications in Neural Prostheses," Dekker, New York, 1977.
79. Glenn, W. L., W. G. Holcomb, J. F. Hogan, T. Kaneyuki, and J. Kim Long-Term Stimulation of the Phrenic Nerve for Diaphragm Pacing, pp. 97-112 in Hambrecht and Reswick (eds.), "Functional Electrical Stimulation, Applications in Neural Prostheses," Dekker, New York, 1977.
80. Waters, R. Electrical Stimulation of the Peroneal and Femoral Nerves in Man, pp. 55-64 in Hambrecht and Reswick (eds.), "Functional Electrical Stimulation, Applications in Neural Prostheses," Dekker, New York, 1977.
81. Hershberg, P. I., D. Shon, G. P. Argawal, and A. Kantrowitz Histologic Changes in Continuous, Long-Term Electrical Stimulation of a Peripheral Nerve, *IEEE Trans. Biomed. Eng.*, 1967, Vol. BME 14, pp. 109-114.
82. Caldwell, C. W., and J. B. Reswick A Percutaneous Wire Electrode for Chronic Research Use, *IEEE Trans. Biomed. Eng.*, September 1975, Vol. BME 22, No. 5, pp. 429-432.
83. Mortimer, J. T., D. Kaufman, and U. Roessmann Tissue Reaction to Intramuscular Electrical Stimulation, *Proc. FASAB*, April 1974.
84. Crago, P. E., P. H. Peckham, J. T. Mortimer, and J. P. Van Der Meulen The Choice of Pulse Duration for Chronic Electrical Stimulation via Surface, Nerve, and Intramuscular Electrodes, *Ann. Biomed. Eng.*, 1974, Vol. 2, pp. 252-264.
85. McNeal, D. R. Analysis of a Model for Excitation of Myelinated Nerve, *IEEE Trans. Biomed. Eng.*, 1976, Vol. BME 23, pp. 329-337.

Computer Applications

86. Barnett, G. O. Computers in Patient Care, *New Engl. J. Med.*, 1968, Vol. 279, pp. 1321-1327.
87. Schroeder, S. A. Commentary: Why the Reservations about Medical Technology?, *Proc. IEEE*, 1979, Vol. 67, pp. 1337-1339.
88. Stacy, R. W., and B. D. Waxman "Computers in Biomedical Research," Vols. I-IV, Academic, New York, 1965-1974.
89. Special Issue on Pattern Recognition and Image Processing, *Proc. IEEE*, 1979, Vol. 67, pp. 707-856.
90. Marmarelis, P. Z., and V. Z. Marmarelis "Analysis of Physiological Systems: The White Noise Approach," Plenum, New York, 1978.
91. Yamashiro, S. M., and F. S. Grodins Optimal Regulation of Respiratory Airflow, *J. Appl. Physiol.*, 1971, Vol. 30, pp. 597-602.
92. Grodins, F. S. "Control Theory and Biological Systems," Columbia University Press, New York, 1963.
93. Blesser, W. B. "A Systems Approach to Biomedicine," McGraw Hill, New York, 1969.
94. Jones, R. W. "Principles of Biological Regulation," Academic, New York, 1973.
95. Brown, J. H. U., and D. S. Gann (eds.) "Engineering Principles in Physiology," Vols. I and II, Academic, New York, 1973.
96. Guyton, A. C., T. G. Coleman, A. W. Cowley, J. F. Liard, R. A. Norman, and R. D. Manning Systems Analysis of Arterial Pressure Regulation and Hypertension, *Ann. Biomed. Eng.*, 1972, Vol. 1, pp. 254-281.
97. Barlow, J. S. Computerized Clinical Electroencephalography in Perspective, *IEEE Trans. Biomed. Eng.*, 1979, Vol. BME-26, pp. 377-391.
98. Lindsay, R. D. (ed.) "Computer Analysis of Neuronal Structures," Plenum, New York, 1977.
99. *IEEE Proc. Comput. Cardiol. Conf.* 1974.
100. Van Bommel, J. H., and J. L. Willens (eds.) "Trends in Computer-Processed Electrocardiograms," North-Holland, Amsterdam, 1977.
101. Thomas, L. H., K. W. Clark, C. N. Mead, K. L. Ripley, B. F. Spenner, and G. C. Oliver Automated Cardiac Disrhythmia Analysis, *Proc. IEEE*, 1979, Vol. 67, pp. 1322-1337.
102. Kak, A. C. Computerized Tomography with X-ray, Emission, and Ultrasound Sources, *Proc. IEEE*, 1979, Vol. 67, pp. 61-71.
103. Jelliffe, R. W., and F. J. Goicoechea Computerized Dosage Regimens for Highly Toxic Drugs, *Am. J. Hosp. Pharm.*, 1974, Vol. 31, pp. 61-71.

104. Scheiner, L. B., M. Halkin, C. Peck, B. Rosenberg, and K. L. Melmon Improved Computer-Assisted Digoxin Therapy, *Ann. Intern. Med.*, 1975, Vol. 82, pp. 619-627.
105. Sheppard, L. C. The Computer in the Care of Critically Ill Patients, *Proc. IEEE*, 1979, Vol. 67, pp. 1300-1306.
106. Albisser, A. M. Devices for the Control of Diabetes Mellitus, *Proc. IEEE*, 1979, Vol. 67, pp. 1308-1320.
107. Schoolman, H. M., and L. M. Bernstein Computer Use in Diagnosis, Prognosis and Therapy, *Science*, 1978, Vol. 200, pp. 976-931.
108. Shortliffe, E. H., B. G. Buchanan, and E. A. Feigenbaum Knowledge Engineering for Medical Decision Making: A Review of Computer-Based Clinical Decision Aids, *Proc. IEEE*, 1979, Vol. 67, pp. 1207-1224.
109. Schultz, J. R., and L. Davis The Technology of PROMIS, *Proc. IEEE*, 1979, Vol. 67, pp. 1237-1244.
110. Collen, M. F. (ed.) "Hospital Computer Systems," Wiley, New York, 1974.
111. Barnett, G. O., and R. A. Greenes Interface Aspects of a Hospital Information System, *Ann. N.Y. Acad. Sci.*, 1969, Vol. 161, pp. 756-768.
112. Barnett, G. O., N. S. Justice, M. E. Somand, J. B. Adams, P. D. Beaman, M. S. Parent, F. R. Van Deusen, and J. K. Greenlie COSTAR: A Computer-Based Medical Information System for Ambulatory Care, *Proc. IEEE*, 1979, Vol. 67, pp. 1226-1237.

Implants

113. Meindl, J. D. Integrated Electron Devices in Medicine, *Tech. Dig. 1977 Int. Electron Devices Meet., Washington*, pp. 1A-1D.
114. Kimmich, H. P., and J. W. Knutti (eds.) Implantable Telemetry Systems Based on Integrated Circuits, *Biotelem. Patient Monitoring*, Special Issue, 1979, Vol. 6, No. 3, pp. 95-106.
115. Van Critters, R. "The Role of Animal Research in Clinical Medicine," National Heart & Lung Institute, NIH, Bethesda, Md., 1973, pp. 3-8.
116. Meindl, J. D. Biomedical Implantable Microelectronics, *Science*, October 1980, Vol. 210, pp. 263-267.
117. Jeutter, D. C. Power Sources for Biotelemeters, *IEEE Eng. Med. Biol. Mag.*, March 1983, Vol. 2, No. 1, pp. 22-23.
118. Weller, C. Infrared Telemetry of the Fetal Electroencephalogram, *Proc. 7th Int. Symp. Biotelem.*, ISOB, Stanford University, August 1982, pp. 152-155.
119. Mackay, R. S. Biomedical Telemetry: The Formative Years, *IEEE Eng. Med. Biol. Mag.*, March 1983, Vol. 2, No. 1, pp. 11-17.
120. Fromm, E. A Thick Film Hybrid Implantable Telemeter, *IEEE Eng. Med. Biol. Mag.*, March 1983, Vol. 2, No. 1, pp. 38-41.
121. Knutti, J. W., H. V. Allen, and J. D. Meindl Integrated Circuit Implantable Telemetry Systems, *IEEE Eng. Med. Biol. Mag.*, March 1983, Vol. 2, No. 1, pp. 47-50.
122. DiPietro, D. M., and J. D. Meindl Optimal System Design for an Implantable CW Doppler Ultrasonic Flowmeter, *IEEE Trans. BME*, May 1978, Vol. BME-25, No. 3, pp. 255-264.
123. Allen, H. V., J. W. Knutti, and J. D. Meindl Integrated Circuits for a Bidirectional Implantable Pulsed Doppler Ultrasonic Blood Flowmeter, *IEEE J. Solid-State Circuits*, December 1978, Vol. SC-13, No. 6, pp. 853-863.
124. Hines, J. W., and H. Sandler Biotelemetry Systems for Spaceflight Applications, *Proc. 7th Int. Symp. Biotelem.*, ISOB, Stanford University, August 1982, pp. 25-28.
125. Drake-Bailey, C., and M. F. Anderson Practical Considerations in the Long Term Use of Totally Implanted, Telemetered Systems in Dogs, *Proc. 7th Int. Symp. Biotelem.*, ISOB, Stanford University, August 1982, pp. 93-96.
126. Allen, H. V., J. W. Knutti, and J. D. Meindl Totally Implantable Directional Doppler Flowmeters, *Biotelem. Patient Monitoring*, 1979, Vol. 6, No. 3, pp. 118-132.
127. Knutti, J. W., E. Wildi, J. Marshall, H. Allen, and J. D. Meindl Totally Implantable Dimension Telemetry, *Biotelem. Patient Monitoring*, 1979, Vol. 6, No. 3, pp. 133-146.
128. Bazuin, B. J., K. Abadi, J. T. Walker, and J. D. Meindl Advances in Totally Implantable Dimension Systems, *Frontiers Eng. Comp. Health Care*, IEEE, Los Angeles, September 1984, pp. 733-737.
129. Sander, C. S., J. W. Knutti, and J. D. Meindl Monolithic Signal Processor for Multichannel Implantable Telemetry, *IEEE ISSCC Dig.*, February 1979, pp. 198-199.
130. Gescwend, S. J., J. W. Knutti, H. V. Allen, and J. D. Meindl A General Purpose Implantable Multichannel Telemetry System, *Biotelem. Patient Monitoring*, 1979, Vol. 6, No. 3, pp. 107-117.
131. E. J. Fleming, W. H. Ko, and M. R. Neuman (eds.) "Indwelling and Implantable Pressure Transducers," CRC Press, Boca Raton, Fla., 1977.
132. Sander, C. S., J. W. Knutti, and J. D. Meindl A Monolithic Capacitive Pressure Sensor with Pulse-Period Output, *IEEE Trans. Electron Devices*, May 1980, Vol. D-27, No. 5, pp. 927-930.
133. Smith, M. J., M. A. Prisbe, J. D. Shott, and J. D. Meindl Integrated Circuits for a Capacitive Pressure Transducer, *Frontiers Eng. Comp. Health Care*, IEEE, Los Angeles, September 1984, pp. 440-443.
134. Harame, D. L., J. D. Shott, J. D. Plummer, and J. D. Meindl An Implantable Ion Sensor Transducer, *Dig. IEEE IEDM*, December 1981, pp. 467-470.
135. Schmitt, J. M., F. G. Mihm, J. D. Shott, and J. D. Meindl Implantable Telemetry for Measurement of O₂ Saturation, *Frontiers Eng. Comp. Health Care*, IEEE, Los Angeles, September 1984, pp. 703-707.
136. Dorman, M. J., J. W. Knutti, H. V. Allen, and J. D. Meindl A Telemetry System for Neural Action Potentials, *Proc. 7th Int. Symp. Biotelem.*, ISOB, Stanford University, August 1982, pp. 33-36.

137. Allen, H. V., and J. W. Knutti A Fully Integrated RF Actuated Battery Controller, *IEEE ISSCC Dig.* February 1981, pp. 166-167.
138. Allen, H. V., J. W. Knutti, and J. D. Meindl Integrated Power Controllers and RF Data Transmitter for Implantable Telemetry, *Biotelem. Patient Monitoring*, 1979, Vol. 6, No. 3, pp. 147-159.
139. Gross, S. J., and J. D. Meindl An RF Command Link for Real-Time Control of Micropower Implantable Telemetry Systems, *IEEE ISSCC Dig.*, February 1984, pp. 210-211.
140. Ford, A. J., and J. D. Meindl Applications of Implantable Telemetry in Laboratory Research, *Frontiers Eng. Comp. Health Care*, IEEE, Los Angeles, September 1984, pp. 724-728.
141. Cobbold, R. S. C. "Transducers for Biomedical Measurements," Wiley, New York, 1974.
142. Allocca, J. A., and A. Stuart "Transducer Theory and Applications," Reston Publishing Co., Reston, Va., 1984.
143. Norton, H. N. "Handbook of Transducers for Electronic Measuring Systems," Prentice-Hall, Englewood Cliffs, N.J., 1969.
144. Doebelin, E. O. "Measurement Systems—Application and Design," McGraw-Hill, New York, 1983.
145. *Sensors and Actuators*, S. Middelhoek (ed.), 1981-1985.
146. *IEEE Trans. Electron Devices*, Special Issues, K. Wise (ed.), December 1979, Vol. ED-26, No. 12, and January 1982, Vol. ED-29, No. 1.
147. *Proc. Int. Meet. Chemical Sensors*, Kodansha, Japan, T. Seiyama, (ed.), Elsevier Pub. Co., 1983.
148. *Dig. 1985 Int. Solid State Sensors Actuators Conf.* June 11-5, 1985, Philadelphia, Pa., U.S.A., International Coordinational Committee on Sensors and Actuators, Electronics Design Center, CWRU, Cleveland, Ohio, 44106.
149. Ko, W. H. Solid State Physical Transducers for Biomedical Research, *IEEE Trans.*, 1986, Vol. BME-33, No. 2, pp. 157-162.
150. Ko, W., and J. Hyncek Dry Electrodes and Electrode Amplifiers, p. 169, in H. A. Miller and D. C. Harrison (eds.) "Biomedical Electrode Technology," Academic Press, New York, 1974.
151. Wise, K., J. Angell, and A. Starr An Integrated-Circuit Approach to Extracellular Microelectrodes, *IEEE Trans. Biomed. Eng.*, 1970, Vol. BME-17, p. 238.
152. Meijer, G. An IC Temperature Transducer with an Intrinsic Reference, *IEEE Trans. Sol. St. Circ.*, 1980, Vol. SC-15, p. 370.

Biomedical Sensors and Actuators

153. Schaffer, H., and O. Koeder A Sensitive All Silicon Temperature Transducer, *Sensors and Actuators*, 1983, Vol. 4, p. 661.
154. Lahiji, G., and K. Wise A Batch-Fabricated Silicon Thermopile Infrared Detector, *IEEE Trans. Electron Devices*, 1982, Vol. ED-29, No. 1, p. 14.
155. Royer, M., et al. ZnO on Si Integrated Acoustic Sensor, *Sensors and Actuators*, 1983, Vol. 4, p. 357.
156. Swartz, R., and J. Plummer Integrated Silicon-PVDF₂ Acoustic Transducer Arrays, *IEEE Trans. Electron Devices*, 1979, Vol. ED-26, No. 12, p. 1921.
157. Yeh, Y., R. Muller, and S. Kwan Detection of Acoustic Waves with a PI DMOS Transducer, *Japan J. App. Phys.*, 1977, Vol. 16-1 (Suppl.), p. 517.
158. Zieren, V., and D. Duyndam Magnetic-field-sensitive Multicollector n-p-n Transistors, *IEEE Trans. Electron Devices*, 1982, Vol. ED-29, No. 1, p. 83.
159. Popovic, R., and H. Balter Dual-collector Magnetotransistor Optimized with Respect to Injection Modulation, *Sensors and Actuators*, 1983, Vol. 4, p. 155.
160. Huijsing, J., J. Schuddemat, and W. Verhoef Monolithic Integrated Direction-sensitive Flow Sensor, *IEEE Trans. Electron Devices*, 1982, Vol. ED-29, No. 1, p. 133.
161. Van Putten, A. An Integrated Silicon Double Bridge Anemometer, *Sensors and Actuators*, 1983, Vol. 4, p. 387.
162. Rahnamai, H., and J. Zemel Pyroelectric Anemometer: Preparation and Flow Velocity Measurements, *Sensors and Actuators*, 1981, Vol. 2, p. 3.
163. Noorlag, D., and S. Middelhoek Two Dimensional Position Sensitive Photodetector with High Linearity Made with Standard IC Technology, *IEEE J. Sol. St. Elec. Dev.*, 1979, Vol. 3, p. 75.
164. Petersson, G., and L. Lindholm Position Sensitive Light Detectors with High Linearity, *IEEE J. Sol. St. Circ.*, 1978, Vol. SC-13, p. 392.
165. Lubke, K., G. Rieder, and H. Thim A High-speed High-resolution Two-dimensional Position-sensitive GaAs Schottky Photodetector, *Sensors and Actuators*, 1983, Vol. 4, p. 317.
166. Ko, W., M. Bao, and Y. Hong A High-sensitivity Integrated-circuit Capacitive Pressure Transducer, *IEEE Trans. Electron Devices*, 1982, Vol. ED-29, No. 1, p. 48.
167. Ko, W., et al. Capacitive Pressure Transducers with Integrated Circuits, *Sensors and Actuators*, 1983, Vol. 4, p. 403.
168. Borkey, J., and K. Wise Integrated Signal Conditioning for Silicon Pressure Sensors, *IEEE Trans. Electron Devices*, 1979, Vol. ED-26, No. 12, p. 1906.
169. Sugiyama, S., M. Takigawa, and I. Igarashi Integrated Piezoresistive Pressure Sensor with Both Voltage and Frequency Output, *Sensors and Actuators*, 1983, Vol. 4, p. 113.
170. Yamada, K., M. Nishihara, and R. Kanzawa A Piezoresistive Integrated Pressure Sensor, *Sensors and Actuators*, 1983, Vol. 4, p. 63.
171. Smits, J., et al. Resonant Diaphragm Pressure Measurement System with ZnO on Si Excitation, *Sensors and Actuators*, 1983, Vol. 4, p. 565.

172. Roylance, L., and J. Angell A Batch-fabricated Silicon Accelerometer, *IEEE Trans. Electron Devices*, 1979, Vol. ED-26, No. 12, p. 1911.
173. Petersen, K., A. Shartel, and N. Raley Micromechanical Accelerometer Integrated with MOS Detection Circuitry, *IEEE Trans Electron Devices*, 1982, Vol. ED-29, No. 1, p. 23.
174. Chen, P., et al. Integrated Silicon Microbeam PI-FET Accelerometer, *IEEE Trans. Electron Devices*, 1982, Vol. ED-29, No. 1, p. 27.
175. Hok, B., C. Ovren, and E. Gustafsson Batch Fabrication of Micromechanical Elements in GaAs-Al_xGa_{1-x}As, *Sensors and Actuators*, 1983, Vol. 4, p. 341.
176. Sansen, W., P. Vandeloos, and B. Puers A Force Transducer Based on Stress Effects in Bipolar Transistors, *Sensors and Actuators*, 1982, Vol. 3, p. 343.
177. Petersen, K. Fabrication of an Integrated, Planar Silicon Ink-jet Structure, *IEEE Trans. Electron Devices*, 1979, Vol. ED-26, No. 12, p. 1918.
178. Cadman, M., et al. New Micromechanical Display Using Thin Metallic Films, *IEEE Elec. Lett.*, 1983, Vol. EDL-4, p. 3.
179. Bel, N. Integrated Capacitive Imaging Display for the Blind, *Proc. 4th European Conf. Electronics*, W. A. Kaiser and W. E. Proebster (eds.), North-Holland Pub. Co., Germany, 1980, p. 549.
180. Senturia, S., S. Garverick, and K. Togshi Monolithic Integrated Circuit Implementations of the Au Charge Flow Transistor Oscillator Moisture Sensor, *Sensors and Actuators*, 1981, Vol. 2, pp. 52-72.
181. Regtien, P. Solid State Humidity Sensors, *Sensors and Actuators*, 1981, Vol. 2, pp. 85-95.
182. Lundstrom, K., M. Shivaman, and C. Svensson A Hydrogen Sensitive Pd-gate MOS Transistor, *J. App. Phys.*, 1975, Vol. 46, p. 3876.
183. Poteat, T., and B. Lalevic Transition Metal-gate MOS Gaseous Detectors, *IEEE Trans. Elect. Dev.*, 1982, Vol. ED-29, p. 123.
184. Terry, S., J. Jerman, and J. Angell A Gas Chromatographic Air Analyzer Fabricated on a Silicon Wafer, *IEEE Trans. Elect. Dev.*, 1979, Vol. ED-26, p. 1880.
185. Fouletier, J. Gas Analysis with Potentiometric Sensors: A Review, *Sensors and Actuators*, 1982, Vol. 3, p. 295.
186. Groset, M., P. Schnell, G. Velasco, and J. Sielka Study of Calcia-stabilized Zirconia Thin Film Sensors, *J. Vac. Sci. Technol.*, 1977, Vol. 14, p. 777.
187. Wen, C., T. Chen, and J. Zemel Gate Controlled Diodes for Ionic Concentration Measurement, *IEEE Trans. Elect. Dev.*, 1979, Vol. ED-26, p. 1945.
188. Bergveld, P. Development, Operation and Application of the Ion Sensitive Field Effect Transistor as a Tool for Electrophysiology, *IEEE Trans. Biomed. Eng.*, 1972, Vol. BME-19, p. 342.
189. Cheung, P., W. Ko, C. Fung, and A. Wong Theory, Fabrication, Testing, and Clinical Response of Ion Selective Field Effect Transistor Devices, pp. 91-118, in P. Cheung et al., "Theory, Design and Biomedical Applications of Solid State Chemical Sensors," CRC Press, Boca Raton, Fla., 1978.
190. Siu, W., and R. Cobbold Basic Properties of the Electrolyte-SiO₂-Si System: Physical and Theoretical Aspects, *IEEE Trans. Elect. Dev.*, 1979, Vol. ED-26, pp. 1805-1815.
191. Matsuo, T., and K. Wise An Integrated Field Effect Electrode for Biopotential Recording, *IEEE Trans. Biomed. Eng.*, 1974, Vol. BME-21, p. 845.
192. Janata, J., and R. Huber Chemically Selective Field Effect Transistors in Ion-Selective Electrode, pp. 31-79, in H. Freiser (ed.), "Analytical Chemistry," Plenum Press, New York, 1980, Vol. 2.
193. Lubbers, D., and N. Opitz New Fluorescence Photometrical Techniques for Simultaneous and Continuous Measurements of Ionic Strength and Hydrogen Ion Activities, *Sensors and Actuators*, 1983, Vol. 4, p. 473.
194. Peterson, J., R. Fitzgerald, and D. Buckhold Fiber Optic Probe for in vivo Measurement of pO₂, *Analyt. Chem.*, 1984, Vol. 56, p. 62.
195. Ko, W., B. Bergmann, and R. Plonsey Data Acquisition System for Body Potential Mapping, *J. Bioeng.*, 1977, Vol. 2, pp. 38-46.
196. Prohaska, O., et al. A 16-fold Semi-microelectrode for Intracortical Recording of Field Potentials, *Electroenceph. Clin. Neurophys.*, 1979, Vol. 47, p. 629.
197. Barth, P., and J. Angell Thin Linear Thermometer Arrays for Use in Localized Cancer Hyperthermia, *IEEE Trans. Elect. Dev.*, 1982, Vol. ED-29, p. 144.
198. Marsolais, E. B., et al. Functional Walking in Paralyzed Patients by Means of Electrical Stimulation, *Clin. Ortho. Reb. Res.*, 1983, Vol. 175, pp. 30-36.
199. Ko, W., S. Wang, and E. Masolais Altitude Sensor for Angle Measurement in Neural Prosthesis, *Proc. 37th ACEMB*, Los Angeles, September 1984, p. 106.
200. Ko, W., J. Hyncek, and S. Boettcher Development of a Miniature Pressure Transducer for Biomedical Application, *IEEE Trans. Elec. Dev.*, 1982, Vol. ED-26, p. 1986.
201. Leung, A., W. Ko, T. Spear, and J. Bettice Intracranial Pressure Telemetry System Using Semicustom Integrated Circuits, Part I: Overall Development, submitted to *IEEE Trans. BME.*, 1985.
202. Ko, W., and C. Fung VLSI and Intelligent Transducers, *Sensors and Actuators*, 1982, Vol. 2, p. 239.
203. Spencer, W. A Review of Programmed Insulin Delivery Systems, *IEEE Trans. BME*, 1981, Vol. MBE-28, p. 3.
204. Karagounis, V., L. Lun, and C. C. Liu A Thick Film Multiple Component Cathode Three-Electrode Oxygen Sensor, *IEEE Trans.*, February 1986, Vol. BME-33+2, pp. 108-112.
205. Prohashka, O. J. New Developments in Miniaturized Electrochemical Sensors, *Technical Dig. 3rd Int. Conf. Solid State Sensors and Actuators*, Philadelphia, June 1985, p. 402.

206. *Workshop on Micromachining Micropackaging Transducers*, November 7-9, 1984, Electronics Design Center, Case Western Reserve University, to be published by Elsevier Scientific Pub. Co., November 1985.
207. Aizawa, M. Molecular Recognition and Chemical Amplification of Biosensors, *Proc. Int. Meet. Chemical Sensors*, Japan, 1983, pp. 683-671.
208. Wingard, L., et al. Electrochemical Measurement with Glucose Oxidase Immobilized in Polyacrylamide Gel, *Biotechnol. Bioeng.*, 1971, Vol. 13, p. 629.
209. Romette, J., et al. Enzyme Electrode for Specific Determination of L-lysine, *Biotechnol. Bioeng.*, 1983, Vol. 25, p. 2557.

Tel: Section 40

Section 40

31 March 1990

Secretariat (Air Staff) 2a,
Room Section 40
Ministry of Defence,
Main Building,
Whitehall,
London SW1A 2HB.

Ref: BUFORA Case Reports into UFO incidents at Little Hayward, Staffs (4 Aug 1988)
and Staffordshire flap (16 May 1988) .

Dear Sir,

With reference to the above BUFORA case reports that were completed by myself on behalf of the British UFO Research Association (BUFORA) and in which copies were passed on to yourselves, I am enclosing the photostat from the latest issue of Northern UFO News (NUFON NEWS), edited by Section 40 which may be of interest to you.

It would seem that not only the poor old MoD are being accused of a 'cover-up' but also the UK's main UFO research organisation as well...

I wish to express my hope that civilian bodies who are responsible and objective can work with official bodies to secure scientific fact, to find the truth from the fiction, and to organise our mutual resources together, in order that scientific data be obtained and evaluated and the public kept intelligently informed at the same time as maintaining required levels of security and costs.

Yours faithfully,

Section 40

BUFORA Midlands Investigator/ Independent UFO Network, and Leicester UFO Centre,

J. R. Comments.

Readers may recall the stories carried in NUN over the past 18 months about mass sightings in Staffordshire. MP Bill Cash got involved and was annoyed at reports by the MoD that the lights were merely holiday air traffic into Birmingham. We, ourselves, reached slightly different conclusions. The local paper (the Staffordshire Newsletter) featured this story a good deal - and in fact first contacted NUN for a quote. Now comes a disturbing sequel.

Barry Heafield (who was the man who first phoned me when the sightings occurred in Spring 1988) published a lengthy article on 15 December 1989, entitled 'Staffordshire UFOs not consistent with aircraft says author'. This is in the guise of a review of Tim Good's book 'UFO Report 1990' (see this issue). However, it contains some curious allegations.

To recap the situation, in NUN 131 (1988) 'UFO F-19 or VC-10?' reports briefly on the 16 May sightings in and around Stafford. I had suggested an F-19 (Stealth) on test from RAF Alconbury because the 'two white headlamps' seen matched earlier sightings that we believe possibly were F-19 flights. Aircraft activity was strongly hinted in this case by the spread of witnesses and the steady flightpath. The VC-10 suggestion came from an aviation enthusiast who was also a witness and who tracked an exercise from RAF Brize Norton that passed over the area. It moved very slowly and included an array of lights for mid-air refuelling. We noted how Clive Potter of LUFODIC and BUFORA was investigating but felt "some form of aircraft explanation is involved in these multi witness (sightings)."

Simple enough, you might think. In the next issue (132) I added how Bill Cash had made his public appeal for witnesses, had found some (who seemed to be reporting new unconnected UFO sightings) and was taking the matter up with the MoD. Meanwhile some aviation experts had supported our suggestion that stealth testing might be going on under the convenient cover of 'if anyone sees it they'll report a UFO and nobody believes in them!' It was suggested that local UFOlogists should assist Bill Cash in his quest. Clive Potter did exactly that, but despite a brief note from the MP promising to report back when he had an answer from the MoD all Potter's future letters to Westminster disappeared into the usual bureaucratic black hole.

Next - in NUN 134 - the debate between Stealth and refuelling exercise raged and I pinned my colours now to the refuelling exercise. We also reported that Bill Cash had got his answer about 'holiday air traffic' and mooted "I suppose we should also believe that (the MoD under-secretary) has the tooth fairy as a grannie" - which more or less shows what I thought of the Birmingham Airport connection. MP Cash was praised for not giving up.

Finally, in NUN 137 (1989) a more detailed account of the 'Night of 16 May' indicated the help the MoD had offered us, providing Clive Potter with copies of other reports for that night. From this a plot could be made of the course of the objects and the aircraft refuelling exercise from RAF Brize Norton - flying VC-10s and smaller jets in convoy - fitted far better than anything else proposed. Clive rightly questioned why the MoD were unable to reach this conclusion, given all their resources. Ergo case closed.

For me this was sensible, first class UFOlogy, concluded by an excellent case file from Clive Potter now logged with BUFORA for anybody who is interested to see copies of several of these NUNs went to the Staffordshire Newsletter to report our findings. So it is puzzling to now discover this recent 'book review' which comments in an atrocious manner on our work.

The paper note that "no satisfactory explanation has been forthcoming from any quarter, including the British UFO Research Association..." (which one must take to mean that our conclusion of the refuelling exercise KNOWN to be on that night and KNOWN to be over the area at the time in question is regarded as unsatisfactory; although no reason for this is offered).

It then goes on to support Tim Good's charges of a 'cover-up' - but not just from the MoD! No - "One only has to telephone the police after a rash of sightings or try to get any kind of real explanations out of the government or BUFORA to know that UFO information is routinely covered up as soon as it has happened"... Worse still, we find that... "Whilst HM government wanted everybody to believe a UFO which burnt a bush last September was really only aircraft lights over Birmingham and BUFORA insisted the May sightings were the Americans test flying their new multi million dollar Stealth bomber, Mr Good is a bit more honest. In dealing with a variety of UFO investigators over the last couple of years I have been left wondering who is sane and who is not..."

But for the desire not to engage in the current mania for lawsuits that threatens to destroy what little credibility UFOlogy has left, BUFORA might by now have taken legal advice over this slur. To allege that we have covered up information and been dishonest because we did not give the paper another sort of answer requires explanation and apology. I am sending the paper a copy of this editorial, so they will have that chance. Heafield knows perfectly well that the 'stealth' suggestion was given off the cuff when he first called me to report the sightings and long before we had any chance to investigate them. Had he read our many reports (in NUN, UFO Brigantia, or elsewhere) (wonderful cover-up!!!) he would have known that our ultimate conclusion favoured the refuelling exercise on 16 May for extensive reasons that seem difficult to refute. As for the other sightings, he should have read our comments on the 'burnt bush' case - as we accepted this was a 'UFO' after EXTENSIVE investigation, involving scientists and sample analysis studies. This, again, has been noted in depth (eg in Brigantia) and my book 'Mind Monsters' published in March features a detailed report.

Sadly, the newspaper are not blameless, because they have distorted some of the facts. The bush was NOT burnt, merely crushed and dehydrated by some force. It happened in August, not September as alleged. The MoD gave an aircraft verdict on the earlier sightings not that particular case.

Indeed, it is interesting to note that in a frank letter to Clive Potter (dated 20 September 1989) Clive Neville of Air Staff 2 (the MoD 'UFO department') says; "In our correspondence with William Cash, MP, to which you refer, I think it would be fairer to say that we merely suggested that the sighting could have been caused by extra air traffic around Birmingham, rather than we concluded, positively, that this was the case... Indeed, from the description of the sighting (in your report) we would agree that it could also have been caused by a tanker exercise, but I regret that due to a lack of time and resources I have been unable to establish this definitely. I was also disappointed to read that our response to Mr Cash was treated as 'yet another' example of MoD secrecy... We do not attempt to cover up the phenomena, and I would suggest that our sometimes rudimentary replies are a product of the lack of significance the subject holds within (the) MoD compared to other more pressing matters..."

It is a shame that the media, UFOlogists and MPs cannot combine forces more effectively than this, because the truth is usually the first casualty of any needless emotive battle. We are, after all, only trying to find out what goes on here - and to start crying 'cover-up' gets us nowhere.

Section 40

Secretariat (Air Staff) 2a



MINISTRY OF DEFENCE

Room Section 40

Main Building Whitehall London SW1A 2HB

Telephone: (Direct Dialling) Section 40
(Switchboard)



Section 40

Your reference

Our reference

D/Sec (A S) 12/3

Date

28 March 1990

Dear

Section 40

Thank you for your letter of 13 March on the subject of Unidentified Flying Objects (UFOs), in which you requested any information we might have on reports generated in the South Wales area.

As you will be aware from previous correspondence, the Ministry of Defence's sole involvement with this subject is to ensure that reported sightings pose no threat to the security of the United Kingdom. We have no department which is appointed solely for the purpose of studying reports, and no staff employed on the subject full time. With this in mind, we do not carry out studies, investigations or surveys into the phenomenon.

With regard to your request for information, I am afraid that our reports are not filed in such a way as to make it easy to pick out those generated in a particular area. We have neither the staff nor the resources to enable us to conduct the searches of our files necessary to compile this type of information. Additionally it should be pointed out that, like all Government Departments, Ministry of Defence files are subject to the Public Records Act, which states that all files are to be closed from general view until thirty years after the last action has been taken on them. This means that we are unable to release small samples of reports, although - as I am sure Mr Neville explained - we are able to answer specific queries about particular incidents which have occurred recently, and can let you know if we have a report on file and, if so, what it contains. If you have a particular enquiry to make, and can provide details as to the date, time and location of the incident, we may be able to be of more assistance.

Finally, the Ministry of Defence received 258 UFO reports in 1989.

I hope this is helpful.

Yours sincerely,

Section 40

Section 40

Secretariat (Air Staff) 2a



MINISTRY OF DEFENCE

Room Section 40

Main Building Whitehall London SW1A 2HB

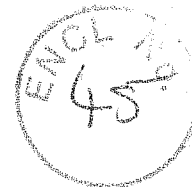
Telephone: (Direct Dialling) Section 40
(Switchboard)

Section 40

Your reference

Our reference

ADG/OA/100/3342

Date

28 March 1990

Dear

Section 40

Thank you for your letter of 13 February to the Under Secretary of State for the Armed Forces on the subject of Unidentified Flying Objects (UFOs). I have been asked to reply.

I was sorry to read of your illness, and I hope that you are now making a good recovery. I am afraid that there is little I can add to our comments in our previous correspondence with you. As you are aware, the Ministry of Defence's sole involvement with this subject is to ensure that reported sightings pose no threat to the security of the United Kingdom. Unless we judge that they do, and I would like to confirm that this has not been the case so far, we make no attempts to investigate further or to identify whatever might have been seen. It is evident that, given this limited involvement with the subject, the vast majority of sighting reports passed to us remain, by definition, unidentified, though we believe that rational explanations could be found for most, if not all, of them.

The Ministry of Defence has no department which is appointed solely for the purpose of studying UFO reports, nor are there any staff employed on the subject full time. The reports we receive, which are usually confined to very brief details of what was witnessed, are examined by staff in the departments concerned with the UK's air defence as a part of their normal duties. It is not, nor has it ever been, Ministry of Defence practice to interview any of the originators of reports. With this in mind, we do not intend to investigate your reported experience further.

I would like to apologise if previous correspondence has not been entirely clear as to the extent of our involvement with this subject, and I hope that you are now fully aware of the position.

Yours sincerely,

Section 40

Section 40

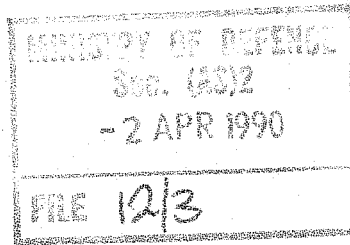

Section 40

Section 40

Secretariat (Air Staff) 2a
Room Section 40
Whitehall
London

27th March 1990.

Dear Sir,

Thank you for your letter of 29th January 1990 concerning my sighting of a UFO.

I did not realise that helicopters travelled in excess of 3000mph in the vicinity of Aldergrove Airport.

Yours sincerely,

Section 40

SM, suggest NFM
COWH
21/6/90



MINISTRY OF DEFENCE

Main Building Whitehall London SW1A 2HB

Telephone: (Direct Dialling) **Section 40**
(Switchboard)

DEFENCE WHITEHALL
2a 44

Section 40

Quebec
CANADA

Your reference

Our reference D/Sec(AS)12/3

Date 26 March 1990

Dear

Section 40

Thank you for your letter of 19 March on the subject of Unidentified Flying Objects (UFOs).

I would like to begin by saying that although we do receive and co-ordinate some information about UFO sightings, the Ministry of Defence's sole concern is to determine whether or not UFOs present a threat to the security and defence of the United Kingdom. Unless we judge that they do, and this is not normally the case, no attempt is made by MoD to investigate or identify the objects.

Regarding the UFO 'report' you refer to in your letter, I feel that it would be inappropriate for me to make any comment as the alleged incident did not occur within UK airspace. However, I can confirm that the Ministry of Defence does not possess any positive evidence to suggest that 'alien spacecraft' have landed on the planet.

Although the UFO reports we receive are unclassified, the release of any material on the subject 'en bloc' is not possible as, like other government departments all MoD files are subject to the Public Records Act. This act states that official files generally remain closed from public viewing for 30 years after the last action has been taken.

I hope this is helpful.

Yours sincerely,

Section 40

From: **Section 40**, Secretariat (Air Staff)2a, Room **Section 40**

Air Press Officer

c/o Air Defence Ministry,
Main Building,
Whitehall,
LONDON.
SW1A 2HB

Section 40

26 March 1990

Dear Sir/Madam,

I am currently attempting to obtain material for an article about Unidentified Flying Objects-Sightings and Explanations.

I believe the Air Ministry has a 'Space Vehicle Sighting Section' and that you may be able to provide me with information.

I should be very grateful for any assistance you are able to render in this matter. I thank you for your kind consideration and look forward to hearing from you in due course. Please find enclosed a sae for your reply.

yours faithfully,

Section 40

ence.

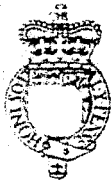

MINISTRY OF DEFENCE

Main Building Whitehall London SW1A 2HB

Telephone: (Direct Dialling) **Section 40**
(Switchboard)



Section 40

Your reference

Our reference D/Sec(AS)12/3

Date 26 March 1990

Dear

Section 40

Thank you for your letter of 8 March on the subject of Unidentified Flying Objects (UFOs).

Although we do receive and co-ordinate some information about UFO sightings, the Ministry of Defence's sole concern is to determine whether or not UFOs present a threat to the security and defence of the United Kingdom. Unless we judge that they do, and this is not normally the case, no attempt is made by MoD to investigate or identify the objects.

The Ministry of Defence does not possess any positive evidence to suggest that 'alien spacecraft' have landed on the planet.

I hope this is helpful.

Yours sincerely,

Section 40

From: **Section 40** Secretariat (Air Staff)2a, Room **Section 40**

42/10

Section 40

Dear Sir,

Thank you for your reply dated 12th January 1990.

I am now able to reply to this letter; you have stated on every occasion that the Rendlesham forest incident was of no defence implication or significance - maybe so, but you seem ignorant of the information available in assessing what phenomenon, natural or man-made, can create low level balls of light causing localised

property damage, animal sensory stimulation and ground traces of radiation.

I merely continue to put this case to you as you are the only source of official information on the case (unless you can recommend police sources also implied in the initial sighting reports.).

In recognition of your lack of information on the taped on-site investigation of the initial sighting I have enclosed a second generation copy of the original (much edited) tape released, by the investigation leader Col. Halt to UFO Investigators. The main comment on the tape is Halt, plus other team members, who have all confirmed the

The tape is genuine. Within the tape is a secondary sighting of five substantially real balls of light moving in the sky and chased by the team on the ground - at this point the tape becomes highly edited but it is purported that this secondary sighting led to a full blown close encounter (of the second kind at least.) It takes a few hearings to understand the conversations but you may find it interesting -

Please return it using the SSAE provided, when you have finished with it.

Meanwhile, my requests for information releases may have

not little response, but in the past the MOD has released a 'small sample' of reports in the past to Ufo Investigators - I do not expect you to do the same for me, but I feel it right to correct you on this matter.

However I thank you for your time and putting up with my enquiries - any other sources of information on the Rendlesham case would be gratefully received.

Yours Sincerely

Section 40

3/3

Section 40

[Redacted]

rang.



He wanted to know [Redacted] extension
 because he said that he [Redacted] had passed
 20 year-old reports to [Redacted] (another
 UFOlogist) whereas we had refused to pass
 reports to him. He asked whether this had
 anything to do with [Redacted] knowing
 [Redacted] father. I said no [Redacted] it was most
 likely that [Redacted] had the files to hand.

He went on to talk about [Redacted] interception
 of UFOs within UK airspace (presumably
 describing the QRA process). I said this was an
 operational matter and I wouldn't discuss it.

Section 40

23/3

0723

March 19, 1990

Section 40

to

Section 40

Section 40

Quebec Canada

Section 40

your Reference

D/SEC (AS) 12/3 Date of your Post Mark September 25, 1989.

ENCL. NO. 4

Dear Sir,

In the early 1950's when I was a member of the British Flying Saucer bureau in Bristol, I was told by then serving R.A.F. officers, that they were not allowed to discuss Flying Saucers with the general public. Early in 1954 the then British Air Ministry issued an order to all Air Force Personnel to the effect that reports of Flying Saucers were restricted information not to be 'developed' to the general Public. But the Air Ministry and now the Department of Defence will still not say why. In your letter of Sept 25, 1989 to

Section 40

you I have repeated the standard statement from Britain, Canada and the U.S.A. that U.F.O.'s do not pose a threat to the National Security, both you and I know that you are not referring to the Misinterpretations BUT to the genuine sightings of unidentified objects in the skies above the Earth.

Sir, you may or you may not know, that a report has been made to the effect that on May 7 1989, a naval frigate radioed Cape Town Naval Headquarters to report an unidentified flying object that appeared on Radar scopes heading at a very high speed of 5746 nautical miles per hour towards the African coast, in a North westerly direction. Naval Headquarters acknowledged and confirmed that the object was also tracked by air-borne radar, Military Ground radar.

Installations, and D.F. Malan international air Port at Cape Town. Officers at VALHALLA air Force base were notified, and 2 Mirage Fighters were sent up armed with the experimental THOR 2 laser cannon. The object was disabled and crash landed 80KM north of South African border with Botswana. Two live crew (aliens - not of Earth) - were taken into custody.

SIR, IF THE UFO WAS NOT A THREAT TO NATIONAL SECURITY? WHY WAS IT BROUGHT DOWN? ALSO, IF SUCH A CRAFT WAS BROUGHT DOWN ON OR NEAR A LARGE CITY SUCH AS LONDON, WHAT WOULD BE THE RESULTS, ??? ?????

Sincerely,

Section 40



OFFICE OF THE
DIRECTOR OF PROJECT

INTERCONTINENTAL U. F. O. GALACTIC SPACECRAFT -
RESEARCH AND ANALYTIC NETWORK ®

DIR. OF PROJECT **Section 40** MEMBER OF THE AMERICAN
INSTITUTE OF AERONAUTICS AND ASTRONAUTICS (A.I.A.A.)

File 12/3
ENCL 40

Section 40

14 March, 1990

Section 40

MINISTRY OF DEFENCE, Room **Section 40**
Secretariat (Air Staff) 2a
Main Building Whitehall
London SW1A 2HB
England Europe

Your Ref.: D/Sec(AS) 12/3

Dear **Section 40**

Your kind and reasonable information on our requests, dated on
25 September, 1989, have been gratefully appreciated.

Regarding the recent intention of the Mighty Powers facing to the
Alien (UFO) Forces created global security problem, we are in full concord
with Her Majesty's distinguished General Staff considerations and obviously
implemented precautionary defence measures.

Please accept our sincere thanks for your cooperative assistance,
we remained

Yours respectfully,,

Section 40

Major Ret. **Section 40**

Section 40

39/1

Ministry of Defence.
Main building
Whitehall
London SW1A 2HB

MINISTRY OF DEFENCE
Sec. (AS)2
14 MAR 1990
FILE

Section 40

13.3.1990

Dear Section 40

I last wrote to you on 9 December 1988, reference D/Sec(AS)12/3.
I was most grateful for your informative reply and would like your cooperation once again.

Relating to the U.F.O. phenomenon, can you please supply me with the latest U.F.O. reports (number of) you received in 1989.

Did the M.O.D. receive any such reports from the South Wales area in 1989 or more recently. If so, you did suggest it may be possible for me to obtain copies of recently reported sightings. Therefore, may I request that you send me any reports the M.O.D. may have from the South Wales area, or from Wales in general.

Yours Sincerely

Section 40

Section 40

19 MAR 1990
FILE 12/3

41
ENCL 30

Section 40

Esq.,
Secretariat (Air Staff) 2a
Ministry of Defence, Main Building,
Whitehall London SW1A 2HB.

Ref d/Sec(AS)12/3

Dear

Section 40

Thank you for your letter of Jan 16 last year - I meant to reply before but it is just as well as I found I had a computer fault. I think that one of the problems with UFOs is we do not have a satisfactory methodology, or even if we had one people would prefer it if we didn't. Thus the Bishop of Norwich says that people who believe in UFOs could be trying to start up a cult. This is a proposition the opposite of which it is impossible to prove.

I enclose some charts of 1367 Ball Lightning events going back to 1850, plotted on the variable length of the Sun's Motion from the Barycentre (it moves a maximum of 1 million miles in an average period of 20 years approx.) The results are none too reliable, for in graph B we get a strong 'peak' in cells 2,3, and 4, these figures have been invented by randomizing the years! The Ball Lightning statistics are taken out of one book, so to get reliable results one would need to take data from other sources and run them as well, to eliminate personal bias.

The Ball Lightning problem seems to be reasonably unemotional.

Yours sincerely,

Section 40

TOTAL QT 1367

Bull lightning 130 yrs up to 1978.

(A)

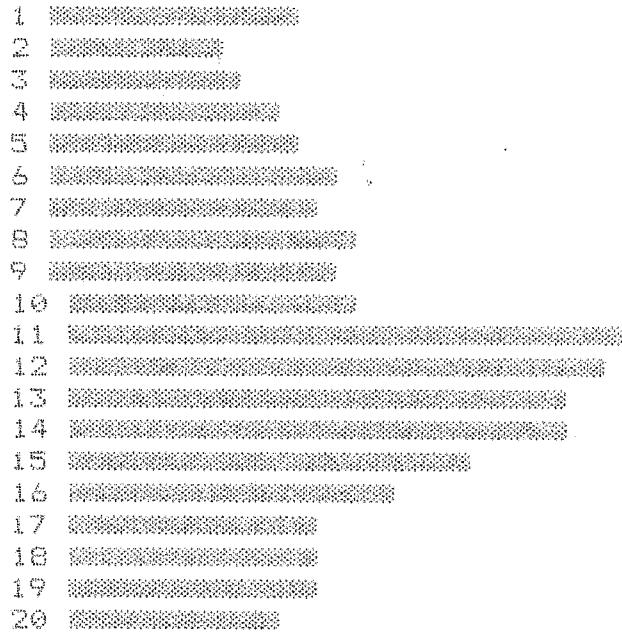

54 38 43 52 55 62 58 68 64 64 118
116 105 106 86 69 56 53 55 45 CHI 165.626189

TOTAL QT 1367

110 100 100 00 07 00 00 40 01 017.12017
TOTAL QT 2734

(B)

1 [redacted]
2 [redacted]
3 [redacted]
4 [redacted]
5 [redacted]
6 [redacted]
7 [redacted]
8 [redacted]
9 [redacted]
10 [redacted]
11 [redacted]
12 [redacted]
13 [redacted]
14 [redacted]
15 [redacted]
16 [redacted]
17 [redacted]
18 [redacted]
19 [redacted]
20 [redacted]

17 135 141 148 47 22 57 98 91 76 27
77 73 79 71 37 28 81 16 45 CHI 451.95022
TOTAL QT 1366

Section 40 [redacted]

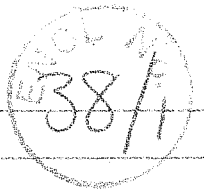

Mansfield UFO Society.

Bingham or RAF Newton.

2+3 5+7 February.

To write letter asking for details.

Sec(As) 2a



12/3

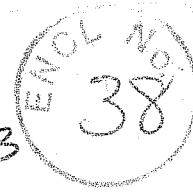

We spoke. 11/16/3

With the compliments of

Section 40

Private Secretary to

Air Member for Supply and Organisation

Ministry of Defence

Main Building Section 40

Whitehall SW1A 2HB

Tel no: Section 40

SAINTS OF GOD CHURCH INTERNATIONAL (S.G.I.)

World HQ

Africa HQ

Asia HQ

Section 40

Section 40

Section 40

ENGLAND

NIGERIA

INDIA

Type of Organisation: 144,000 end-time saints scattered throughout all nations - plus women and children in submission.

Leadership: Section 40 end-time Apostle and Prophet in the power of Elijah.

Purpose: To prepare the 144,000 end-time saints (plus women and children in submission) for the Second Coming of Christ and the soon coming Day of Wrath, by restoring the laws of God that were given to mankind at Horeb inc. circumcision, 7th Day Sabbath, 7 Special Sabbaths, Feast Days, and dietary laws. At present, the sacrificial laws are only continued through the bread (grain offerings) and red wine (animal offerings) which represent the Body and Blood of Christ. However, the sacrificial laws pertaining to the Temple will be reintroduced when the Temple in Jerusalem is rebuilt. The end-time apostle and prophet has also power to correct misleading teachings concerning circumcision, Sabbath, Feast Days and dietary laws promulgated by the Apostle Paul, and give guidance on all matters of faith and conduct, even as Moses did in the wilderness. All conflicting viewpoints will be answered in accordance with the law of God given to Moses and the words of Yahshua Ha Mashiah - and NO OTHER person, whether they be angel, apostle or prophet. For as the Apostle Paul himself said, ONLY be followers of me, as I am of Christ.

Membership/Affiliation: 144,000 end-time saints, circumcised in both heart and flesh, comprising 12,000 from each of the 12 Tribes, inc. both Israelites and grafted-in Gentiles, plus women and children in submission. Total approx. $\frac{1}{2}$ million scattered throughout all 7th Day congregations of Yahshua in all nations.

History: Section 40 means highest point, and Section 40 means priceless) was called by Divine intervention i.e. no human agency, to be an end-time apostle and prophet in the power of Elijah on 31st Dec 1972 aged 22 yrs. Since then the Lord has been preparing him for his task in preparing the 144,000 end-time saints. Much of this preparation was spent in India, and he has an Indian wife Section 40 and 5 children. The Lord has guided him into restored truth by direct revelation of the Holy Spirit. Section 40 was the first son, born on the Feast of Firstfruits 1950, which represents the resurrection of Christ; and his first

Section 40

son, [redacted], was born on the Day of Atonement 1987, which represents the resurrection of the saints; and both were circumcised on the 8th day in accordance with the law of God [redacted] being circumcised by [redacted] himself.

The exact location of the Mount of God at Horeb has also been revealed to [redacted] as well as the exact route of the Exodus and borders of the Promised Land as given by Yahshua, son of Nun (type of Yahshua, Son of Elohim). St Anthony has since fasted on the Mount of God for 7 days in Feb/March 1988, which is situated in Northern Sinai near the Wadi El Arish and is known today as Gebal Halal, which means 'Holy Mountain.' As a result of his sojourn on the Mount the Lord has revealed that Israel will be invaded by the forces of Antichrist in Summer of 1994; and, consequently, we only have a few years left to the commencement of the Day of Wrath, which takes place some months prior to the invasion of Israel.

[redacted] is, however, a human being and NOT infallible - thus he is open to correction and reproof, but only in accordance with the law of Elohim and the words of Yahshua Ha Mashiah.

[redacted] is also NOT one of the 2 prophets who prophesy in Jerusalem for $3\frac{1}{2}$ yrs during the Day of Wrath period. These 2 prophets will be the true Enoch and Elijah come back in the flesh.

Distinctive Points of Doctrine: Restoration of the law of God inc. Circumcision, 7th Day Sabbath, Feast Days, and dietary laws. Restoration of only ONE LAW for both Jew and Gentile (Ex 12.49). Sealing in forehead by the angels of God of 144,000 end-time saints at commencement of Day of Wrath. Post-tribulational rapture and resurrection of the saints. The Man of Sin is the end-time leader of the 10 nation Communist Bloc, and Rome is Mystery Babylon, the Mother of Harlots.

Evangelistic Efforts: Literature publication covering end-time restoration of the law and end-time events. Fellowship with Lord's Supper every Sabbath eve at commencement of 1st day of the week. [redacted] is prepared to speak and have fellowship with any person or group who feel they are part of the 144,000 end-time saints. He is also prepared to be a witness to those who have not come into restored truth.

Publications: [redacted] Speaks booklets, tracts and newsletters. Maps of Exodus inc. location of Mt Sinai and all stopping places, and borders of Promised Land as given to Yahshua, son of Nun.

Published by [redacted] Saints of God Church Inter'l

[redacted]

PREPARING THE SAINTS FOR THE SECOND COMING OF CHRIST

OPERATION EARTH

The Interplanetary Council of the Sovereign God has deemed it necessary for the salvation of planet earth to launch a MASS INVASION at the end of this decade.

Surveillance operations were begun in earnest after the first atomic bombs were exploded, and operations have continued to increase in readiness for the FINAL PUSH at the turn of the century.

We will, therefore, be launching large scale aerial attacks on Antichrist forces throughout the earth, which will result in the greatest tribulation ever known to man.

These attacks will NOT be nuclear, but biologically compatible, such as large scale earthquakes, plagues of various kinds, floods, famines, cosmic upheavals etc.

These attacks have ALREADY BEGUN to some degree (4 Horsemen of the Apocalypse), and will eventually culminate in the Biblical DAY OF WRATH.

Meanwhile, on earth mankind will be divided between 2 Power Blocs - the Northern Power Bloc, which is a DEMOCRATIC DICTATORSHIP led by the Antichrist (Beast); and the Southern Power Bloc, which is an ISLAMIC DICTATORSHIP led by the Mahdi.

The leader of the interplanetary invasion forces, known on earth as Jesus Christ, has repeatedly warned the inhabitants of planet earth of the consequences of their actions in refusing to obey the Universal Laws of the Creator; and although the governments of the world have, at present, placed a veil of secrecy over our surveillance operations and forthcoming invasion to defeat the governments of the world and establish the Kingdom of God here on earth - that secrecy is soon to be shattered when we begin our full scale invasion of the planet - which will eventually culminate in the BATTLE OF ARMAGEDDON.

If, however, mankind had REPENTED of its SINS and allowed us to redeem the planet peaceably as originally intended - then there would have been no cause to adopt the present tactics. However, mankind, as in the days of Noah, leaves us with NO ALTERNATIVE - even as Jesus the Christ warned you.

Likewise, the various Satans that are, at present, governing this planet and are steering the governments towards a FINAL SHOW-DOWN with God will, likewise, be defeated at the Battle of Armageddon.

This message comes to the people of earth at the MIDNIGHT HOUR, and you are urgently warned to REPENT of your sins NOW, before its too late.

MAN, THE COSMOS AND GOD

Between man, the cosmos and God there exists a symbiotic relationship whereby man, the cosmos and God are in a state of ecological equilibrium with one another. That is to say, they are symbiotically interacting with one another physically, mentally and spiritually to produce an overall state of ecological balance and well-being.

When, however, this state of equilibrium is upset either physically, mentally or spiritually there results a corresponding upset in the symbiotic relationship between man, the cosmos and God. This upset is now abundantly seen all around us in the physical sickness, mental strife and spiritual sin that have been plaguing mankind for the last 6000 yrs, and even more so today.

Our aim, therefore, must be to promote the restoration of this symbiotic relationship between man, the cosmos and God - thus restoring the ecological equilibrium that is so essential to the survival of mankind and the planet on which he resides.

Now, obviously, this restoration is going to require help from higher intelligences than ourselves, who have hopelessly made a complete mess of ourselves and the world in which we live. Thus, the necessity of Divine revelation is of paramount importance in the rectification of the present world situation. This is why God-ordained prophets, anointed by the power of the Holy Spirit, are of supreme importance in bringing about this restoration.

In addition to this, it is also important to understand that because this planet is under the ultimate authority of God, however fallen and unstable it is at present, there will eventually come a time when God Himself, along with other superior intelligences, will return once again to the earth to establish God's Kingdom upon it. In Biblical terms, this is described as the Second Coming of Christ, who is accompanied by vast armies of saints and angels, to establish the Kingdom of God here on earth.

Thus, it should be understood that because the forces of evil are in the majority on this planet there will of necessity, be a consequent upsurge in the degree of ecological instability - physically, mentally and spiritually. However, this upsurge is soon to reach it's peak within the next few years, but because the nature of evil is basically self-destructive, there will come a point where God Himself will intervene to save mankind from utterly destroying himself.

However, our duty at this present moment in time is to restore the ecological equilibrium in our lives and in the world around us as best we can, in readiness for the complete restoration when Christ returns.

Published by **Section 40** Saints of God Church Inter'l

Section 40

PREPARING THE SAINTS FOR THE SECOND COMING OF CHRIST

THE LAST DECADE

Mankind has now entered into the last decade of this age of existence on this planet, which will culminate in the Second Coming of Christ and the establishment of the New Age or Millennial Kingdom of heaven on earth.

This decade, therefore, is the transitional period during which the changeover from the old to the New Age will take place.

To give you some idea of the massive upheavals that have to take place during the next 10 years to bring about this change, I will first of all outline some of the things which will no longer exist in the New Age of heaven on earth.

1) No nuclear bombs or any non-ecologically compatible weaponry of any kind ie. there will be famines where pockets of resistance to God's Kingdom still exist.

2) No banks or money of any kind ie. work will be done out of love and not based on selfish gain, and goods will be shared with those in need.

3) Non-ecologically compatible technology and industry will be superceded by ecologically compatible forms of technology ie. virtually all existing man-made technology will be scrapped eg. motor cars, aeroplanes, factories, nuclear power stations etc.

4) No artificial drugs or butchering of people's bodies by drills and scalpels ie. healing will be brought about by nutritional, mental and spiritual means.

5) No artificial borders, passports or visas ie. the earth will be common to all and all will be allowed to settle in the place of their choosing.

6) All democratic dictatorships will be superceded by a theocratic dictatorship based on love ie. the Universal Laws of God.

Now, to inaugurate these changes will necessitate a complete upheaval of life as we know it during the next 10 years.

This upheaval is outlined quite vividly in the Book of Revelation; and will basically involve massive upheavals of the earth's crust and increasing judgments upon nations opposed to God's rule, culminating in the Battle of Armageddon where Christ and His angels defeat the forces of Antichrist.

These changes are absolutely necessary for the ultimate good of the planet in restoring the ecological balance and the establishment of God's Kingdom here on earth.

If, therefore, you wish to prepare yourself for these changes I would urge you to live as simply as possible in complete obedience to God and His laws - these laws can be found in the Books of Moses and the teachings of Christ.

THE THIRD WORLD WAR
has already happened!

Dear friend, are you aware that the 3rd World War has already taken place - and is STILL taking place!

Now, to explain, we all know about the 2 atomic bombs that were dropped on Hiroshima and Nagasaki in 1945 resulting in the loss of over 100,000 lives. However, are you aware that since 1945 about 1700 atomic bombs have been exploded around the world in so-called 'peace' time.

Well, all I can say is, if this is peace - then I'm for WAR!

You see, dear friends, there is a SECRET war going on against the human race by the powers of DARKNESS.

You see, mankind can easily spot a war when both sides declare war, but what happens when both sides keep saying 'peace, peace' - when there is NO peace. For did not the Bible prophesy that the governments of the world would be declaring peace when in fact there is WAR (Jer 6.14).

You see, Satan is the Father of LIES, and has DECEIVED the WHOLE world (Jn 8.44 & Rev 12.9); and it is he who has misled the people into believing we are at peace, when in fact we're at WAR.

Satan, also, is the one who manipulates governments for his own ends - that is why he tempted Jesus by saying he would give him all the kingdoms of the world if Jesus would worship him. However, Jesus had come to save the world from Satan's clutches and so rebuked the Devil and commanded him to worship God.

It would seem, however, that Jesus has done a poor job of saving the world - but, like Satan, He is working secretly behind the scenes saving a soul here and a soul there, in readiness for the final overthrow of Satan and the forces of Antichrist at the Battle of Armageddon.

- That time, now, is fast approaching as the effects of 1700 atomic bombs is rapidly causing life on earth to become extinct - with millions now dying of cancer and heart disease, and radiation levels now reaching saturation point.

Meanwhile, the British and other governments have firmly pledged to continue exploding atomic bombs ad infinitum - so that except those days are shortened, no flesh would be saved (Matt 24.22).

Thank God, however, those days WILL be shortened when Christ returns to defeat the governments of the world and establish the kingdom of God here on earth.

Let us, therefore, REPENT of our sins and prepare ourselves for His soon return.

Published by **Section 40** Saints of God Church Inter'l

Section 40

PREPARING THE SAINTS FOR THE SECOND COMING OF CHRIST

THE UFO'S AND GOD

Nowadays, it is a common occurrence for people to see flying saucers, and also make contact with visitors from outer space. However, what many people fail to realise is that the Bible also refers to life in outer space.

Let us first look at the locations of heaven and hell in the Bible - for as is commonly known, heaven is 'up there' and hell is 'down there'. However, many people fail to grasp the implication of what they are saying.

In Gen 1:8 heaven is described as the 'sky' or 'firmament', and says 'God called the firmament 'heaven' - thus, heaven in the Bible is 'outer space'. Secondly, in Ezk 31:16 it refers to hell being in the lower parts of the earth - thus, hell is located below the surface of the earth. Thus, when a person dies with their soul either goes 'down' into hell or 'up' into heaven - depending on the deeds they have done.

Now, having established the locations of heaven and hell, we will now show how the Bible describes life in outer space, and how, very soon, some startling events are to take place there.

Let us, therefore, turn to Rev 12.4 which states that the Devil cast a third of the STARS down to earth. This, however, does not mean that the universe collapsed in on the earth, but that aliens from planets in this sector of the universe who are under the authority of Satan i.e. forces opposed to God, came down to the earth to rule over it.

However, in v.7-9 God decides to rectify the situation by sending Michael and his angels to make war against Satan and his angels; which results in a major conflict in the heavens i.e. outer space, the outcome of which is that Satan and his angels are defeated and retreat down to earth.

Then in v.12 it gives the conclusive PROOF of life in outer space by saying, 'Rejoice ye heavens and ye that DWELL in them. Woe to the inhabitants of the earth - for the Devil has come down to you having great wrath, because he knows his time is short.'

Friends, STAR WARS is REAL, and will come upon us sooner than you think! In fact, there are already alien bases on the earth - one, for instance, near Dulce, New Mexico and another in the White Hills of New Hampshire.

However, we need not fear as Christ Himself also ascended into heaven i.e. outer space, and said that He would RETURN in a like manner along with His angelic forces to defeat the forces of Antichrist and set up the Kingdom of God here on earth (Acts 1.11 & Rev 19.11-20.3).

Let us, therefore, prepare ourselves for Christ's soon return by keeping the faith of Jesus Christ and the commandments of God (Rev 12.17).

CREATION OF THE WORLD

In Gen 1 we find the well known story of how God created the world - however, what many people fail to realise is that the account of creation ONLY refers to this SOLAR SYSTEM.

In fact, the account clearly states that the heaven that God created at that time was only that portion of sky between the earth and the clouds (v. 6-8).

In fact, the only reference to STARS is found in v. 16 which certainly does not give any clear indication that God made the stars at the time He made the earth - although some versions would have us believe He did. However, in the KJV it is clear that the words 'He made' in reference to the stars is NOT in the original text; and that the only clear reference to creation in the verse is concerning the sun and the moon. The reference to the stars appears only in connection with the giving of light at night along with the moon - but no specific reference is made to their creation.

Science, however, has shown that new solar systems come into being at different times; and thus, our particular solar system was created about 6000 yrs ago. This, of course, means that other civilisations were in existence long before life on earth - which also accounts for the numerous visits of extra-terrestrials that have been witnessed by people down through the ages.

The creation, however, of our solar system was the responsibility of 2 men from the Godhead - the Godhead being a UNITY of ONENESS which manifests itself through CREATION. This 2 man team is known in scripture as the Father and Son who are 2 HUMAN manifestations of the Godhead who are responsible for creating life here on earth in this sector of the universe.

However, certain sectors in the galaxy were not in unison with the Godhead and were rebellious against the Father and the Son. They then, in turn, sought to establish their rulership here on earth - which resulted in the earth becoming corrupted.

The Father and Son, however, devised a plan of redemption for the earth to enable the earth to be restored to its former glory; and for those who have chosen to obey God's commandments to be exalted to positions of rulership along with the Father and Son.

Thus, we see that man is by no means alone in this vast universe, and the earth itself is but a speck in the vast ocean of space.

Likewise, also, we realise that God in His entirety is much greater than just 2 human individuals who made man in their image in this tiny corner of the universe - yet these 2 individuals are the manifestation of the Godhead who have been given charge over us; and, therefore, it is to them, and them alone, that we must worship as our Creator and Redeemer.

THE TREE OF KNOWLEDGE

The Tree of Knowledge is described as the Tree of Knowledge of GOOD and EVIL. The Tree of Knowledge is also described in relation to God as being an attribute of the Divine Nature (Gen 3.5,22). The Tree of Knowledge may better be described, therefore, as the Tree of WISDOM or the Tree of DISCERNMENT between GOOD and EVIL.

Now, although God had commanded man not to eat of the tree, it was also in the Divine Plan that he DOES eat of it; but that in eating of it, he would have to forego eating of the Tree of Life until such time as he proved himself to be able to choose the GOOD rather than the evil - that is why God told him that when he eats of the Tree of Knowledge, he will surely DIE (Gen 2.17).

Man, therefore, to become like God, had to take of the Tree of Knowledge of Good and Evil i.e. the Tree of Wisdom or Discernment; otherwise, he could NOT become a true son of God. Likewise, Christ also took from the Tree of Knowledge during His childhood and grew in wisdom and the grace of God (Lk 2.40,52).

Therefore, the Tree of Knowledge or Wisdom is an essential part of our development as sons and daughters of God - however, because the acquisition of knowledge and wisdom is a slow process that requires a prolonged testing period whereby it can be shown that we have chosen to do the GOOD rather than the evil, the Tree of Life is kept from us until such time as we have proved our worthiness to live forever.

That is why there has to be a Day of Judgment when God judges all men on their WORKS i.e. whether they have chosen to obey God's commandments or disobey God's commandments.

Now, concerning God's commandments, one of the greatest heresies that the Devil has promulgated is that God's commandments no longer exist, and that people are now free to do as they want.

This heresy is especially prevalent in the CHURCH where the doctrine is put forth that ALL God's commandments were 'nailed to the Cross' and done away with. This heresy is a complete abomination to God and has resulted in millions of Christians having to suffer the fires of hell to purge them of their sins - which could have been avoided if the commandments of God were clearly preached from the pulpit.

The lack of preaching of the laws of God has also resulted in the tragic misuse of the earth's resources and the rapid destruction and pollution of our environment - which if God did not intervene, would mean the END of the world. However, God in His mercy is going to intervene and destroy all evil from the earth and RESTORE the earth to its NATURAL state.

Let us, therefore, take only that which is GOOD from the Tree of Knowledge, so that we may be allowed to partake of the Tree of Life and live forever in God's Kingdom.

GOD IS A MAN

Many people regard God as unknown and unknowable - however, the Bible clearly shows that this is NOT the case.

Let us first turn to Gen 1.26 where God said 'Let us make man in our image' - thus, also, if we reverse the sentence we see that God is in the image of MAN.

Secondly, it is clear that when Adam and Eve were in the Garden of Eden, God was also living with them - for it says, 'God was WALKING in the garden in the cool of the day' (Gen 3.8).

Likewise, in Gen 3.21 it says, 'God made some clothing for them from animal skins' - which also proves, by the way, that God is not against killing animals for the purpose of clothing to people.

Also, even after Adam and Eve were driven out of the Garden, God was still physically present when Cain and Abel presented an offering to Him, and also shortly afterwards when Cain slew his brother and God set a mark on him (Gen 4.1-15).

Another striking incidence of God physically appearing as a man was when God and 2 angels came to visit Abraham to tell him that his wife was to have a son, and to warn him of the impending destruction of Sodom and Gomorrah (Gen 18).

Note, especially, in Gen 18.2 that it specifically mentions that both God and the angels were MEN. There is, therefore, no question that the God of the Bible is a MAN. However, God in His entirety is a UNITY of ONENESS, and ALL beings who are incorporated into that Oneness become a part of God.

Thus, when we are regenerated and 'born again' we become sons and daughters of God, just as Christ and the angels are sons and daughters of God - Christ, however, is pre-eminent as He is the FIRSTBORN Son of the Father of this world's creation (Col 1.15, 1 Rev 3.14 & Prov 8.22-31).

Thus, the whole of creation emanates from God, and is a part of God. However, God in His entirety is incomprehensible to man as He is both in the universe and beyond the universe - our planet being like a tiny grain of sand in the midst of the ocean of space.

The God, however, that we have to serve and worship is the Father and the Son of this world's creation who communicate themselves to us through God's Holy Spirit.

God, therefore, relates to us through the mediary of a human form in a physical sense, and through the Holy Spirit in a spiritual sense.

Published by **Section 40** Saints of God Church Inter'l

Section 40
PREPARING THE SAINTS FOR THE SECOND COMING OF CHRIST

THE TRUE ALIENS

Many people believe that aliens are little green men from Mars - however, a true alien is actually much more closer to home.

To find out, therefore, who the true aliens are, let us first turn to the Bible - which, believe it or not, has a lot to say about aliens.

First of all, the Bible says that God Himself is an alien who resides in the heavens - which, in Biblical terms, means 'outer space' (Gen 1.8).

Those, however, who reside inside the earth and on the surface of the earth are referred to as 'evil spirits' and 'sinners'.

In this respect, the lower regions of the earth are referred to as 'hell'; while on the surface of the earth reside the 'sinners' - who, in turn, are guided by the evil spirits who inhabit the lower regions of the earth, and who also manifest themselves on the surface through possessing the bodies of the sinners - which, in the Bible, is called 'demon possession'.

Another form of this is witchcraft, where sinners on the surface co-operate with the evil spirits below the surface to manipulate circumstances for their own ends. This co-operation with the spirits of the underworld is also manifested through mediums and clairvoyants who temporarily allow their bodies to be taken over by these spirits.

This is why ALL these practices are forbidden in the Bible, because the God in the heavens does not want sinners to be controlled by the spirits of the underworld, but He wants us to be controlled by the Spirit of God.

Now, for a sinner to be controlled by the Spirit of God means that God must RECREATE us to be His children. That is why Jesus spoke about being 'BORN AGAIN' (Jn 3.3).

Now, when we are 'born again' of the Spirit of God we then are transformed into the children of God; and thus, are no longer children of this world, but are children of the heavenly world.

That is why Jesus says we are 'NOT OF THIS WORLD' and that His Kingdom is not of this world; and that is why the Bible also says that all the saints down through the ages have been ALIENS on the earth (Jn 17.16, 18.36 & Heb 11.13).

So, if you want to see a true alien, then just look for those who have been REGENERATED by the Holy Spirit, and who keep the faith of Jesus Christ and the commandments of God (2Cor 5.17 & Rev 12.17).

THE BRAIN POWER

As you, no doubt, are aware the brain is a highly sophisticated piece of equipment which enables us to think and to control how we act.

However, what many people fail to realise is that the brain is also a highly sophisticated TRANSMITTER and RECEIVER.

In fact, the brain is able to transmit and receive messages over vast distances of space many billions of miles away in just a few seconds.

Scientists, however, have failed to realise this fact, and are busy building vast receivers on earth costing millions of pounds to try and pick up messages from space.

However, ever since the dawn of creation there has been in existence in every human being a transmitter and receiver which can send and receive messages from the outermost regions of the universe in a matter of seconds.

Now, in Biblical terms, this transmission of information is called PRAYER, and reception of information is called REVELATION.

However, just as we have to dial the right number to reach the right person - so, likewise, you have to speak to the right person when utilising prayer.

Now, the Bible says there are many gods in the world going by all kinds of different names - however, those who wish to contact the Supreme God must call Him by His Name - which, in the Hebrew tongue, is called 'YAH' meaning 'I AM' - which also is rendered YAH-WEH meaning YAH - THE ANCIENT OR ETERNAL ONE, and YAH-SHUA meaning YAH - THE SAVIOUR. These last 2 terms are usually given nowadays to the Father and the Son respectively to help distinguish one from the other - however, as God is a ONENESS, all 3 terms are interchangeable as all refer to God and all utilise the basic root 'YAH' or 'I AM'.

So, in praying to God, we must direct our prayers to the Supreme God, which is YAH - the God of Abraham, Isaac and Jacob; otherwise, we are liable to receive transmissions from other gods who are not in subjection to the Supreme God; and who will, therefore, lead us astray - that is why Yahweh says you shall have no other gods before Me; and that is why we are commanded to pray to God in Yahshua's Name (Ex 20.3 & Jn 16.23).

Published by **Section 40** [REDACTED] Saints of God Church Inter'l

Section 40

PREPARING THE SAINTS FOR THE SECOND COMING OF CHRIST

ENDANGERED SPECIES

Many people are aware that thousands of animal species are becoming extinct throughout the world.

However, what many people fail to realise is that one of the most endangered species is Man himself.

This danger has been brought about by 2 contributing factors - firstly, the development of an industrialised society; and secondly, the rapid increase in world population.

Now, first of all, the earth was never designed to sustain an industrial based society - which is all the more aggravated by an ever increasing population which is industrially based.

If, however, society was agriculturally based then the earth would be able to sustain a massive population far in excess of what we have today; but because society is industrially based it cannot even sustain the present level of population, let alone an ever increasing one.

This then results in mass starvation of millions of people, together with a massive increase in deaths due to poisonous waste from industry entering into the food chain and the atmosphere causing cancer, heart disease, premature death and a multitude of other diseases.

The only remedy, therefore, is to get back to an agriculturally based society where each family group has its own house and land to grow crops and to raise livestock.

This, by the way, is a God ordained Biblical principle; and is, therefore, the only way the earth will be able to sustain an ever increasing population, while maintaining an ecological balance.

These 2 factors, therefore, must be taken into consideration if this planet is going to sustain mankind into the 21st century.

If, however, mankind persists in continuing on its present course, the Bible has predicted that remedial action of a more severe kind will have to be brought into operation.

This remedial action will entail a complete upheaval of the earth's crust, resulting in a complete destruction of industrialised society as we know it.

This upheaval can be compared to the farmer ploughing his field before sowing his crop - which then enables the seed to take root and bring forth fruit.

Thus, if mankind continues on its present course without reverting back to an agriculturally based society, then God Himself will rectify the situation by destroying man-made industrialised society and bringing the earth back to its natural state to enable the seed of God's Kingdom to take root and grow.

Let us, therefore, do all in our power to return to a self-supporting, agriculturally based lifestyle to enable the ecological balance to be maintained and an ever increasing population to be sustained.

ECOLOGY AND THE CAR

The motor vehicle is the PRIME source of a sustained pollution of the atmosphere - which, in turn, contaminates the rainwater - which, in turn, contaminates the seas, the rivers, the land and everything on earth.

What happens, in effect, is that carbon monoxide emissions eventually converts to carbon dioxide in the atmosphere - a substance deadly to man and all living creatures. Thus, as the level of carbon dioxide increases in the atmosphere, the level of life supporting oxygen consequently decreases.

With this in mind, if, for instance, we had a scenario where everyone in India and China had a motor car i.e. about 2 billion people, or about $\frac{1}{2}$ the world's population, then all life on earth would become extinct virtually overnight.

However, if this wasn't bad enough, carbon dioxide also has the property of retaining infra red heat from the sun - thus contributing to the greenhouse effect, resulting in a gradual global warming and the melting of the polar ice caps - the result of which would be that vast land masses would sink under the sea; some, of which, would include England, Ireland and Holland.

Furthermore, carbon dioxide also combines with rain water to form carbonic acid; which then falls as acid rain contaminating land, sea and rivers.

In addition to this, however, is the emission of nitric oxide - which also combines with rain water to form nitric acid; which also results in clouds of nitric acid pouring down acid rain upon the earth.

Also, the combination of nitric oxide and nitrogen in the atmosphere can result in the formation of nitrous oxide or laughing gas - so I suppose one could say that, at least, we would all die laughing!

Finally, but by no means least, there is the emission of LEAD into the atmosphere which is deadly poisonous to all living creatures - and, once breathed in, is stored in the nervous system of living creatures, especially in brain tissue; which results in ever increasing mental derangement and eventual death.

It should also be noted, that current legislation regarding lead emissions does NOT solve the problem of existing lead in the atmosphere; NOR does it prevent the emissions of lead from car exhausts - but only REDUCES the emissions of lead to a lower level.

With all this in mind, what we propose as an interim step, is to make compulsory the fitting of catalytic converters to all car exhausts to remove all harmful emissions, with the ultimate goal of scrapping the motor vehicle altogether and reverting back to a NATURAL and ECOLOGICAL means of transportation, such as the horse and sailing ship.

THE DARK ONES

The Dark Ones are those in the unseen world who are controlling the forces of evil on this planet.

The Dark Ones are controlling the governments of this world, the schools and medical institutions, newspapers and television, music and entertainment, factories and industry, and just about everything pertaining to this present world system.

They are, in fact, controlling what we see, what we do, what we think, what we eat and what we breathe.

They are the princes of darkness of this present world system who are leading mankind on the pathway that leads to destruction.

They are the ones who initiated the Industrial Revolution, they are the ones who have destroyed our earth, polluted our rivers, poisoned our air, contaminated our food, and caused a myriad of plagues and sicknesses to destroy mankind.

They are the ones that have started world wars, let off atomic bombs, built atomic power stations, spilt oil over the seas, pumped deadly fumes into the atmosphere, sprayed chemicals on our crops, and caused the whole of mankind and life as a whole to degenerate and decompose into one giant rubbish heap of sickness, disease and death.

Life on this planet, and the world as a whole is now decomposing so rapidly that mankind is liable to become extinct by the turn of the century.

The very air we breathe is now so full of carbon monoxide and lead that most people are walking around half asleep and behaving like a bunch of mindless zombies.

The clouds in the sky are now composed of nitric and carbonic acid which is rapidly eating away and destroying everything it falls on.

The ozone layer is now virtually non-existent with vast holes appearing all over the world.

All parts of the planet are now saturated in radio-active fallout from hundreds of atomic bomb tests, let alone the tons of radio-active waste from nuclear reactors that are dumped all over the place.

The earth's crust is also now beginning to buckle and give way as millions of tons of oil are sucked out from underneath it, causing massive earthquakes around the world.

People are also poisoning their bodies through drugs, pills, cigarettes and alcohol.

Doctors are also mutilating people's bodies by slicing them open, ripping out organs and playing around with people's genes.

Dentists also have ruined people's teeth by mutilating them with drills and ripping them out so as to force people to wear dentures.

Friends, we must become AWARE of what the Dark Ones are doing to the human race. We must SPEAK OUT against their evil machinations - for the Dark Ones know that their time is short and that the Divine Order is soon to be restored again upon the earth.

They are, therefore, accelerating their programme of destruction, knowing that their end is near.

Friends, there is HOPE for the world - for Christ Himself said 'I shall return'. Thus, as this age draws to a close and the New Age dawns, let us go forth and proclaim the Good News of the soon coming Kingdom of God and the destruction of the forces of darkness - for all things pertaining to this current world system are to be destroyed and God's Kingdom of peace and happiness is to be restored once again upon the earth.

* * * * *

END-TIME SAINTS

In view of the onslaught of the Dark Ones upon mankind and the world as a whole, God is preparing an end-time army of 144,000 saints who will declare war against the forces of darkness and be ready for when Christ returns.

At the forefront of this end-time army is God's end-time apostle and prophet who has been called to prepare the world for the soon coming Kingdom of God.

The end-time prophet has already been given numerous revelations to bring people back to a more spiritual and ecologically balanced lifestyle to enable them to overcome the Dark Ones and be ready for when Christ comes.

These revelations include the restoration of the Divine Laws of God, the healing of sickness through spiritual means without damaging body tissue, and the filling of teeth without damaging them through drilling.

If you wish to know more about how to become an end-time saint and put into practice the revelations received by God's end-time prophet, please feel free to contact us at the address below.

Published by St **Section 40** Saints of God Church Inter'l

Section 40

PREPARING THE SAINTS FOR THE SECOND COMING OF CHRIST

ST ANTHONY'S SURE GUIDE TO SUCCESS
Physically, Mentally and Spiritually

Since the dawn of creation mankind has been beset with all kinds of ills - both physically, mentally and spiritually.

The Bible says that mankind is a fallen species ie. it has fallen into physical sickness, mental torment and spiritual sin.

Physical, mental and spiritual health are all interlinked, and thus a symptom in one indicates a disease in all.

Thus, the human race for about the last 6000 yrs has been plagued with physical, mental and spiritual sickness which has now resulted in a literal hell on earth.

Mankind, however, has constantly been searching for ways to solve the problem - but generally, has ended up creating more problems than it has been able to solve.

This is basically due to mankind's tendency to try and solve problems without being in accordance with Universal Law. Thus, mankind has adopted techniques which are out of accordance with the Divine Will; and, consequently, have resulted in ecological disaster for both man and the planet on which he resides.

Now, to be perfectly frank, there is no way mankind is going to be able to rectify the global situation without a Divine intervention. This Divine intervention is known in Biblical terms as the Second Coming of Christ.

However, we as individuals can do something to restore our own ecological balance both in our bodies and in the areas in which we live - but a full restoration will only be achieved after Christ has returned.

However, it is important for our own physical, mental and spiritual well-being to commence that restoration now in readiness for the complete restoration when Christ returns.

Firstly, it's important to become familiar with the Divine Will and the Universal Laws which govern mankind.

These laws are found in the first 5 Books of the Bible - however, to begin with your first step is to become familiar with the basic Ten Commandments found in Ex 20.

Now, as you study through these 5 Books - and especially those parts which specifically reveal the Divine Law, you will become gradually aware of those areas in your life which are out of accordance with the Divine Order.

When, therefore, you become aware of these areas of your life you will need to adjust your lifestyle in accordance with the Divine directives. This, obviously, will be a gradual process - but you have to start somewhere.

Probably the best way is to start with the 1st Commandment in Ex 20 and adjust your lifestyle accordingly; then go on to the 2nd Commandment and do likewise; followed by the 4th, 5th, 6th and on up to the 10th.

Then, once you have achieved this, you can then look to the other more detailed commandments. Included in these are basic ordinances of circumcision or the cutting of the foreskin, baptism or the Divine washing, and the Eucharist or the eating of the Bread and the Wine in remembrance of Christ's death.

Now, once you have reached this stage you will be well on the road to ecological equilibrium in your life.

One personal word which has been of great benefit to me both physically, mentally and spiritually is the habit of FASTING.

Fasting, of course, is strongly advocated throughout the Bible, and is compulsorily enjoined at least once a year on the Day of Atonement. However, regular fasting is a God ordained way of keeping the body fit and healthy, and the soul in tune with the Divine Will.

For example, when the Apostles could not cast out an evil entity from a person, Yahshua (Jesus) advised them to fast and pray to enable the Divine Power to flow through their body more freely. Thus, fasting is of paramount importance in overcoming evil influences in our life.

Not only this, but it also keeps our body in excellent shape and optimum health. The body, in fact, really only needs ONE good meal a day to sustain it in perfect health. Thus, people, especially in the West, are grossly overfed - which consequently results in all kinds of diseases and a separation from the Divine Will; thus allowing evil entities to take control.

Now, I personally, have proven that fasting does work. I have personally fasted many times where I have totally abstained from ALL forms of food, including water. Other times I have gone on a prolonged fast with water only - and on one occasion I have fasted with water only for over 40 days.

However, I have discovered that as a general rule you only need to eat or drink during the EVENING ie. I personally only now eat and drink after 5pm, and do not allow myself to eat or drink anything between MIDNIGHT and 5pm the following day.

Now, to achieve this you will have to go through what I call a 'breaking in' period of 100 days. That is to say, the body will take approx 100 days to adjust to eating and drinking only in the evening.

Once this is achieved, you will only WANT to eat and drink in the evening, as the mind and body will have adjusted itself to only expect an intake of food and drink at that time.

This, then will enable you to achieve peak performance, physically, mentally and spiritually, and will bring about an ecological equilibrium in your life.

Published by **Section 40** Saints of God Church Inter'l

Section 40
PREPARING THE SAINTS FOR THE SECOND COMING OF CHRIST

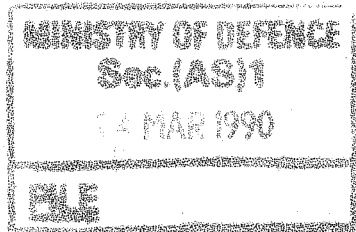

20 8th, March, 1990

37/1

The Air Ministry
Whitehall,
London.

Dear Sir:

Your first reaction to this letter will be one of pure disbelief however, let me assure you I am neither insane or a charlatan as the facts will prove.

During W.W.2, as I am sure you are aware, a crashed U.F.O. was recovered by the military somewhere in this country. I should like to know the exact date and location of this event?

It is possible this was Pusslock Warren the location of which I am as yet unable to discover. There are several options, Wistman's Wood by West Dart Devon, between Gars Point and Blackstone Point Devon, the Norfolk coast or Wenlock Edge. In fact the name Pusslock Warren could be quite wrong, it just came into my mind one morning from whence I know not.

The crashed vehicle contained two males from Spectra, a planet orbiting the star Zeta Tucanae and a female from one of the two inhabited planets in the Sirius system, Amegon the planet of warrior women. That female was me. So I have a right to ask my question. (see sketch 1.)

Spectrans are very white with oriental features no hair and 'Mr. Spock' ears. They can and do interbreed with Terrans.

Although Spectra is a member of the Federation of Nine you may not know them. The people you work with are from a planet orbiting 82 Joridani. They are your 'brothers' descendants of Adam. (This planet may be Thebal.)

I will now acquaint you with my story in brief.

I am a Wearer of the Purple, a top rank in the military. Some years ago our President, Adrasta, asked me to come to Earth, with

Utriana, an other Wessex of the Purple, to check out what was going on.
(I was very familiar with Earth.)

This woman betrayed me and I was captured by Spectra troops.

I protested. They ignored me. I killed them - I remember them lying peacefully over the control console with its rows of small square push buttons in chalky shades of grey, blue, yellow and pink. Colours they use a lot.

I was wrong. I cut the drive confident my death would free me from them. The vehicle fell like a brick (To this day I hate lifts because of that little falling feeling one gets.)

When it struck the ground I must have lost consciousness for the next memory is of laying face down on the floor my head on its left side limbs spread out. A piece of cloth in front of me I think (see sketch 2.) I suppose the two also fell on the floor. A warm feeling spread through my body. It was quite nice until it stopped me from breathing easily my eyesight blurred and then blackness.

Whilst my body lay in the U.F.O. I was taken into the Spectra computer. That was a strange experience.

The parents of my present body were chosen in 1940. They saw a rocket shaped U.F.O. trailing a blue flame, and experienced a strange stillness.

Although Spectra rule me they will not tell me why I am here.

They have an other body just like this one. It lies in a bed wearing a sort of helmet from which hangs a thick cable plugged into a computer probable, behind a panel on the wall.

I hope you can answer this letter.

Yours faithfully

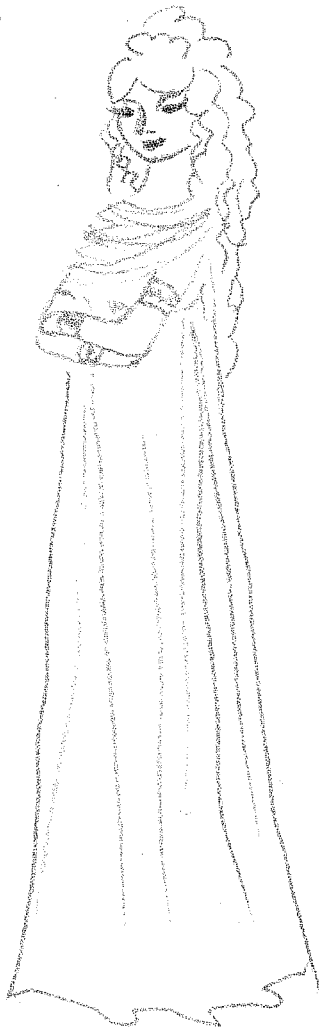

The
gown
purple.

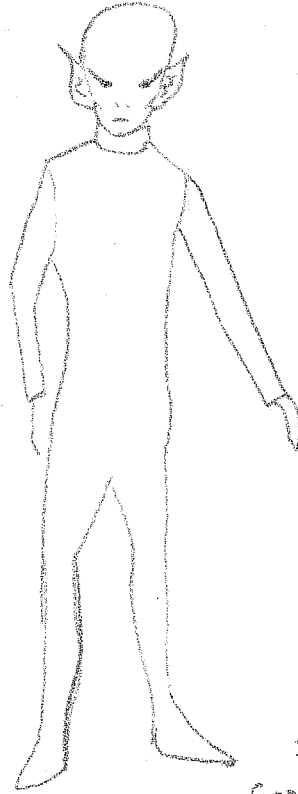

Spectre
garment black
with white bands
close to cuff sometimes
showing rank.

One white band is a pilot.
Top brass have 6 band of dull red
on each side of chest, from shoulder
to waist.

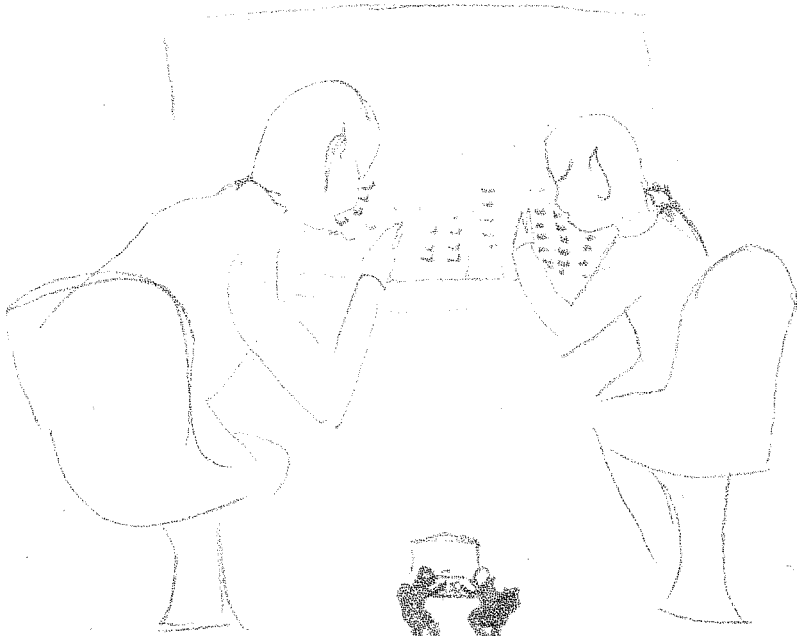

ENCLOSURE
37

Section 40

Secretariat (Air Staff)2a,
Room Section 40
Ministry of Defence,
Main Building Whitehall,
London SW1A 2HB

Section 40

Date: Mar. 7th, 1990
Ref: 90-0307/2

Dear Section 40

I acknowledge with thanks the receipt of your letter dated 02 MAR 1990, in response to my letter to Earl of Arran.

I am expecting you reply with regards to my earlier letter to you dated 02 FEB 1990, which somewhat predates to my letter to Earl of Arran.

Yours sinerely,

Section 40

cc: file.



MINISTRY OF DEFENCE

Main Building Whitehall London SW1A 2HB

Telephone: (Direct Dialling) Section 40
(Switchboard)

36

Section 40

Your reference

Our reference D/Sec(AS)12/3

Date 7 March 1990

Dear

Section 40

Thank you for your letter of 2 February on the subject of Unidentified Flying Objects (UFOs).

To begin, I would like to reiterate that it is not our practise to interview people in connection with UFO sightings. The Ministry of Defence has no department which is appointed solely for the purpose of studying reports of UFOs and we have no staff who are employed on the subject full time. We do not have the resources to undertake any further investigation or general survey.

I can tell you that the UFO sighting reports we receive are referred to our staff in the departments which are responsible for the air defence of the United Kingdom, and who examine the reports as part of their normal duties.

It has now been ascertained that, contrary to the impression given in the House of Lords debate of 4 March 1982, a number of files in the class AIR 20 dealing with UFO reports dated prior to 1967 are available for inspection at the Public Records Office.

I am afraid that I cannot provide you with copies of the last two UFO sighting reports received by ourselves in 1989. The release of any material on the subject 'en bloc' is not possible as, like other government departments all MoD files are subject to the Public Records Act. As you may be aware, this act states that official files generally remain closed from public viewing for 30 years after the last action has been taken. However, we are able to answer any specific queries you may have about particular incidents which have occurred recently (i.e. within the last three years) and can let you know whether we have a report on the incident and if so what it contains.

I hope this is helpful.

Yours sincerely,

Section 40

From: Section 40 Secretariat (Air Staff)2a, Room Section 40

35

AL

From: Section 40 Secretariat
(Air Staff)2a



MINISTRY OF DEFENCE Room Section 40
Main Building Whitehall London SW1A 2HB

Telephone Section 40 (Direct Dialling)
(Switchboard)

Section 40

Your reference

Our reference

AOG/OA/100/3342

Date

7 March 1990

Dear Section 40

Thank you for your letter of 13 February to the Under Secretary of State for the Armed Forces, on the subject of Unidentified Flying Objects (UFOs).

Your letter is receiving attention, and I hope to be in a position to offer a full reply in the near future.

Yours sincerely,

Section 40



Department of Transport

Room **Section 40**
2 Marsham Street London SW1P 3EB
Telex **Section 40**

34/1

Direct line **Section 40**
Switchboard **[REDACTED]**
GTN **[REDACTED]**

AIS (M)
LATCC (Mil)
Porters Way
W Drayton
MIDDLESEX
UB7 9 K

Your reference

Our reference
AP/13/010

Date 5 March 1990

Dear Sir or Madam,

REQUEST FOR INFORMATION - UFO'S

I enclose the attached letter from a **Section 40** requesting addresses on the above subject. I have been given to understand that your section deals with these queries and I would be grateful if you would reply to **Section 40** direct.

Yours faithfully,
Section 40
[REDACTED]

Civil Aviation Policy Division 2

With Compliments



City of Westminster

Press and Public Relations Division

WESTMINSTER CITY HALL · 64 VICTORIA STREET · LONDON SW1E 6QP

TELEPHONE **Section 40**

date 15-1-1990.

to the
british council house
victoria street
London
England

Section 40

AMSTERDAM
NETHERLANDS

department
information

CAP?
S7/04?

subject
address information

esteemed british council house
department information

HERE A information LETTER

PLEASE CAN YOU SEND ME
THE ADDRESSES

FROM THE UNIDENTIFIED FLYING OBJECTS / UFO ASSOCIATION
IN ENGLAND
AND FROM THE ASTRONOMY ASSOCIATION
IN ENGLAND

AND HERE BY I WAITING FOR YOUR INFORMATION LETTER
AND WITH THE ESTEEM HIGHLY GREETINGS

Section 40

Section 40

Secretariat (Air Staff)2a



MINISTRY OF DEFENCE Room Section 40

Main Building Whitehall London SW1A 2HB

Telephone: (Direct Dialling) Section 40
(Switchboard)



Section 40

Your reference

Our reference

D/Sec (AS)12/3

Date

5th March 1990

Dear Section 40

Thank you for your letter of 19 February on the subject of Unidentified Flying Objects (UFOs), in which you requested any information we might have on three unusual sightings.

A search of our files has revealed that, contrary to the press reports, the Ministry of Defence did not receive any details of these incidents.

I am sorry I cannot be more helpful.

Yours sincerely,

Section 40

Section 40

Section 40

Secretariat (Air Staff)2a

ENCLOSURE
33



MINISTRY OF DEFENCE

Room Section 40

Main Building Whitehall London SW1A 2HB

Telephone: (Direct Dialling Section 40)
(Switchboard)

Section 40

Your reference

Our reference

D/Sec(AS)12/3

Date

5th March 1990

Dear

Section 40

Thank you for your letter of 8 February on the subject of Unidentified Flying Objects (UFOs).

I am sorry that you were not entirely satisfied with my reply to your previous letters. I would like to make it clear that military aircraft are not permitted to overfly Blackpool at low level without the express permission of Blackpool Air Traffic Control. Firing of missiles of any kind over populated areas is prohibited, so I am of the opinion that that detail of this report can be discounted. It is also exceedingly doubtful that any military aircraft would be seen as late as 11.10pm. You yourself implied that this report might be a hoax; I consider this the strongest possibility.

I hope this is helpful.

Yours sincerely,

Section 40

Section 40

Section 40

Secretariat (Air Staff)2a



MINISTRY OF DEFENCE

Room Section 40

Main Building Whitehall London SW1A 2HB

Telephone: (Direct Dialling) Section 40
(Switchboard)

Section 40

Your reference

Our reference

D/Sec(Air)12/3

Date

5th March 1990

Dear

Section 40

Thank you for your letter of 24 January, on the subject of Unidentified Flying Objects (UFOs) in which you requested any information we might have on an incident on 8 January.

To answer your first question, the Ministry of Defence did not receive any reports relating to this date. As far as establishing whether or not RAF aircraft were in the area at the time is concerned, it would be helpful if you could be a little more precise as to the location, perhaps providing a map reference. Finally, we are not aware of any aircraft equipped with headlamp type lights, though it should be pointed out that all aircraft do have landing lights which are of course very bright.

I hope that you will find this helpful.

Yours sincerely

Section 40



MINISTRY OF DEFENCE

Main Building Whitehall London SW1A 2HB

Telephone: (Direct Dialling) **Section 40**
(Switchboard)



Section 40

Your reference

Our reference ADG/OA/100/3344

Date 2 March 1990

Dear **Section 40**

Thank you for your letter of 16 February to The Earl of Arran on the subject of Timothy Good's books 'Above Top Secret' and 'UFO Report 1990', which has been passed to the Air Staff Secretariat for reply.

The contents of your letter have been noted. However, I feel that it would be inappropriate for me to make any comment as the points you raise appear to be a matter for the United States authorities.

I hope that this has been of some help.

Yours sincerely,

Section 40

From: **Section 40** Secretariat (Air Staff)2a, Room **Section 40**

From: Section 40

Secretariat (Air Staff)2a

MINISTRY OF DEFENCE

Room Section 40



Main Building Whitehall London SW1A 2HB

Telephone: (Direct Dialling) Section 40
(Switchboard)



Section 40

Your reference

Our reference

D/Sec(AS)12/3

Date

26 February 1990

Dear

Section 40

Thank you for your recent letter on the subject of Unidentified Flying Objects (UFOs), in which you enclosed a tape recording for our attention.

I think it would be helpful if I begin by reminding you that the Ministry of Defence has a very limited involvement with this subject, our sole concern being to determine that no threat has occurred to the United Kingdom's defences. With this in mind, I am afraid that neither of the incidents apparently documented on this tape is of any interest to us, as both occurred outside UK airspace. I am therefore returning the tape to you.

I hope this is helpful.

Yours sincerely,

Section 40



LOOSE MINUTE

D/CS(R)1/6/1/3 **Section 40**

Feb 1990

Sec (AS)2a **Section 40**"UFO" RECORDS AT THE PUBLIC RECORD OFFICE, KEW

Reference A. D/Sec (AS) 12/3 dated 13 Feb 90

1. Thank you for the useful collection of letters to and from **Section 40** forwarded with the reference.
2. Enclosed is a copy of our reply to **Section 40** letter (also enclosed) which itself was in response to our letter to **Section 40** ref D/CS(R)1/6/1/3 dated 19 December which we sent you a copy of late last year.
3. Neither this office, nor the PRO, keep a subject index but enquiries at AHB(RAF) where they have a UFO "buff", **Section 40** who previously worked for the PRO, have revealed that the following files containing references to UFOs are available to the general public at Kew:

AIR 16/1199	1952 Flying Saucers Occurrences Reports by Service personnel at Topcliffe Station, Thirsk and local public sector.
AIR 20/7390	1950-54 Unidentified aircraft (Flying Objects) Reports.
AIR 20/9320	1957 PQs on UFOs
AIR 20/9321	1957 PQs on UFOs
AIR 20/9322	1957 PQs on UFOs
AIR 20/9994	1950-54 Reports on aerial phenomena
PREM 11/855	File from the Prime Minister's Office

Should you wish to examine any of these files, please let me know and I will call them up from the PRO.

4. If either **Section 40** or **Section 40** writes on again I will forward the letters to your office.

Section 40

Hd CS(R)1

Section 40



CS(R)1
Ministry of Defence
St Christopher House Southwark Street London SE1 OTD
Room **Section 40** Telephone Operator **Section 40**
Direct Dia **Section 40**

Section 40

Your reference

Our reference

D/CS(R)1/6/1/3

Date

22 February 1990

Dear **Section 40**

I refer to your recent undated letter concerning files at the Public Record Office containing references to UFOs.

I am sorry that you feel that my letter to **Section 40** was unhelpful. However **Section 40** was asking for an explanation of why government files are closed to examination by the public and I explained that the authority for closure for 30 years is the Public Records Acts of 1958 and 1967. As I also explained, security considerations have no bearing on this period of closure. All government records, irrespective of any security classification, or lack of it, are closed for 30 years under the provisions of these Acts. Copies of the Acts are available from HMSO Bookshop.

Our information regarding the destruction of UFO reports prior to 1967 came from a House of Lords debate on the subject on 4 March 1982. It was stated that since 1967 all UFO reports have been preserved. Before that time they were generally destroyed after five years.

Following your letter which indicates that, contrary to the impression given in the House of Lords debate, there are files available in the Public Record Office, we have made further enquiries and established that there are files available in class AIR 20, but doubtless you have already examined these. Other relevant material will, of course, be progressively transferred to the PRO when it reaches the 30 year point prescribed by the Public Records Acts.

Yours sincerely

Section 40

MINISTRY OF DEFENCE
CS (R) 1
11 JAN 1990
ST. CHRISTOPHER HOUSE

ENCL NO.
5

Section 40

Deputy Departmental,
Records Officer,
Common Services(Records)1,
Room Section 40
Ministry Of Defence,
St Christopher House,
Southwark St.,
London, SE1 0TD

Section 40

Dear Section 40

✓ A copy of your letter referenced D/CS(R)1/6/1/3, dated 19.12.1989, has been passed on to me.

✓ In my time I have read a good amount of official garbage thrown at people, but your letter could be nominated as an excelant piece standing tall amongst the others. WHY?

For your information, we do have in our possession UFO documents dating to 1957, hence your comments in your third paragraph of your letter is nothing short of...

✓ You have mentioned that currently there are no UFO documents available in PRO, would you like me to give you the reference number of the files available in PRO? Or, you would withdraw them in order to fulfill your comments in your fourth paragraph?

✓ I can not understand why MOD treats people's inquiry with regards to this subject with such contempt. Either you are fully aware of the facts I mentioned in this letter, or this is yet another attempt to keep the public in the dark when a subject of this seriousness is brought to your attention.

✓ You seem to have a fairly brief knowledge about the history of the UFO proceedings, what I can not understand is the fact that you are trying to cover up that little amount of material which has been officially released from the public. Why?

✓ Finally, could you explain to me what is the defference between the classified material and un-classified. If a subject is unclassified why should it be kept under the lock for 30 years? It simply does not make sense, could you make any sense out of it, I am eager to know.

Yours Truly
Section 40

Encl: copy 1957 doc. on UFO
cc: files.

1.
S.6.

I should be grateful for a definite reply and notes to this question not later than 5.0 on Wednesday 8th May. I understood that you already have a set of press cuttings about the object pursued on 29th April.

I attach a recent P.O. 193/54 in connection with which you provided some background information and an earlier question of Major Wall - P.O. 196/55.

Section 40

S4.6.
1/5/57

2.

D.D.I. (Tech)

I should be grateful for advice on both parts of this question. I suggest that the definition of "UFO's detected" should be regarded as reasonably authenticated and reliable reports, including radar reports, for which no satisfactory explanation has been advanced. Thus for 1955 and 1956 together (para.1 of your min.3 on P.O. folde 193/57 attached) the maximum number would appear to be 6. I should be glad of figures for 1955, 1956 and 1957 to date, separately.

2. I understood from what A.C.A.S.(I) said at the Air Staff meeting yesterday that reports of the incident of 29 April were still very collated. I should be glad c

ENCLOSURE
29/2

OUR REF: ADG/OA/100/3342

..... Sec(AF)

The attached letter from Section 40

..... is forwarded to you for official action. this letter has/~~has~~ not been acknowledged from this office. The Minister attaches great importance in prompt replies to correspondence he receives and would like this letter answered by COP 7th March 90, or alternatively, if a delay is anticipated, an interim reply should be forwarded, preferably within the same timescale.

Would you please let us see a copy of your reply quoting our reference. If this correspondence is transferred, then this office must be notified.

Section 40

AA/US of S(AF)

Section 40

21 FEB 1990
.....

Section 40 - 04
20 FEB 1990

Tel Section 40
Tel [redacted]
MOD
LONDON

Section 40
[redacted]

Case goes back
8 Yrs Ago

13th February 1990

File Prob destroyed

0A/100/3342

Dear Section 40

Eight years ago my Mother and I had a UFO sighting whilst travelling home from Southport to Manchester, a craft, which was soundless, hovered forty feet above our car causing electrical problems and mechanical interference.

My Mother and I two ordinary people endured a terrible experience, so profound, that after all these years we are still haunted by it. We both lost almost one hour out of our lives during this experience that we cannot account for either consciously or when hypnotically regressed.

I wont go into detail about the sighting because I am sure that you have it on file already. After the experience I wrote to the MOD on two occasions. Months later I received a letter from the department suggesting that we both visit a doctor;- (which we found very insulting) My second letter was ignored.

Shortly after I wrote my second letter I fell very ill Section 40 needless to say, I have been preoccupied to say the least, fortunately now I am much better and would like to carry on where I left off..

I would like your explanations as to why, you, as an official government body are deliberately and seriously misleading the public by stating as you did a couple of years ago that the MOD investigate all UFO sightings. I have this on video tape but I would like to quote, word for word, what you said on that programme.

" Our job in the MOD is a rational and I hope, a painstaking and calm way to investigate all UFO sightings and reports. We are reponsive, we are reactive, and we investigate them thoroughly and satisfy ourselves that there was no threat to national security. If there had been at any time of the sighting then our reponse would have been immediate."

The MOD send out a standard letter to the public who report a UFO sighting -(if they are lucky)- saying that, although some UFO sightings can not be explained, as long as they are of no threat to UK air space, the ministry is not concerned or interested. Dont you think for one minute that a controlled and highly sophisticated machine that can hover forty feet above a car is close enough for it to be invading UK air space.?

Thousands of frightened people who have reported a similar experience to ours get absolutely no response from the MOD; no rational explanation, and neither do they get a reative response, or any form of painstaking investigations that you claim. ~~My colleagues and I have been researching UFO reports and abduction cases for years,~~ and not once has the MOD shown the slightest glimmer of concern or interest at any one time. It strikes me Section 40 that you are talking through your hat.

Professional

Forgive me if my letter comes across as being bitter, but if you in the department are insensitive enough to suggest that UFO witnesses should resort to seeing a doctor, then what do you expect?.

Cont'd

Many people who report a sighting are usually articulate, honest, and very down earth and quite frankly, they can do without all the ridicule, the hurt and humiliation, that comes along after the report. I admit that the media are mainly responsible for a lot of this. They appear to delight in turning most UFO sightings into a mickey taking exercise. But the MOD is a very different kettle of fish. Your whole attitude towards these witnesses should change drastically.-

Of course I am not so naive as to believe that some witnesses are disturbed, or lonely, and are desperately trying to bring attention to themselves. But a serious researcher has very little trouble in bottoming these bogus reports. Indeed, my colleagues, and I, have met a few so called Ufologists who are bordering on the unhinged; which is unfortunate and doesn't help the cause at all. Most of the cases that we have been involved in are totally genuine, and cannot be explained away.

As a result of your television appearance, I now wish to make an official complaint.

My Mother and I, were threatened by a craft of unknown origin, on the 10th January 1982. This threat took place in UK air space and we both lost fifty five minutes of time out of our lives. As a result of this threat and the missing time, it has left both of us extremely upset and frightened as to what happened during this missing time.

We are available at your convenience for the department to painstakingly investigate our experience, we hope that you will be responsive and expect you to be reactive, as you so adamantly claim to be.

I am yours sincerely

Section 40

ENCL No. 9/1

OUR REF: ADG/OA/100/3344

..... Sec(AS)

Section 40

The attached letter from . [redacted]

..... is forwarded to you for official action. this letter has/~~has~~ not been acknowledged from this office. The Minister attaches great importance in prompt replies to correspondence he receives and would like this letter answered by COP 7th March 90, or alternatively, if a delay is anticipated, an interim reply should be forwarded, preferably within the same timescale.

Would you please let us see a copy of your reply quoting our

reference. If this correspondence is transferred, then this office

must be notified.

Section 40

21 FEB 1990

.....

AA/US of S(AF)

Section 40

0A/PO/3344

Sec (AS)

19 FEB 1990

Section 40

The Earl of Aaran,
Parliamentary Under-Secretary of State
for Defence for The Armed Forces,
Ministry of Defence,
Main Building Whitehall,
London SW1A 2HB

Date: Feb. 16th, 1990
Ref: 90-0216/3

Dear Sir,

I am enclosing herewith some documents, which are classified Top Secret/Eyes Only. These documents are not declassified and have been made public by a gentleman called Timothy Good in his book titled "Above Top Secret". When Section 40 was questioned by some citizens with regards to the methods by which he obtained these documents, he mentioned that he received them from a CIA source. In his recent book (Relevant copies enclosed), as it could be seen he has confirmed his comments.

Through the inquiries I have made with the CIA through the FOIA regulations, I am told that one page of these documents which allegedly belongs to CIA is fake. However, despite our several inquiries via FOIA to other US establishments, we have not had any denial on these papers.

In one letter that Section 40 has written to a researcher in US, when he has been asked to answer certain specific questions (Copies enclosed), he has not denied his role in so many words as a "Controlled Informant" and furthermore, he has gone further to say that he "was given the permission to reproduce these documents". So far, despite our repeated attempts in trying to get precise answers from Section 40 about, where and from whom he has obtained these documents, he has kept his silence. In one of the pages of his second book, which I have enclosed herewith, he believes that these documents are authentic. This does raise some important questions in fact:

- A. Does Section 40 as he claims, have CIA sources which leak out this type of top secret documents?
- B. Is it legal?
- C. Does he work for any foreign agency? If so, is it legal for him to actually to make it public?
- D. Is it a campaign of disinformation organized by certain governments targeting certain community?

If these documents are fake and fabrication, is it legal for him to reproduce them in his book as a factual evidence, and sell thousands of copies? Is not a fraud? If it is, who should make an attempt to stop it. We have witnessed the so called Hitler's diary, and now this. The difference is that, there no-body cashed in, whilst in this incident, right under the nose of the authorities Section 40 has sold enormous numbers of his book?

The fundamental point which seems to be important to be established is that, whether even under the freedom of speech, it is allowed such type of material which clearly implicates the governments involvement, and does leave halmarks in the readers' mind, to be published by certain individuals who make such unusual claims concerning the ways and methods they have applied to receive these type of documents, irrespective of the text.

Looking forward to hearing from you, I remain.

Yours sincerely, *ed*

Section 40

Encl; MJ12 Documents

Pages from UFO Report 1990, By T. Good.

Copies of Section 40 and Section 40 Letters.

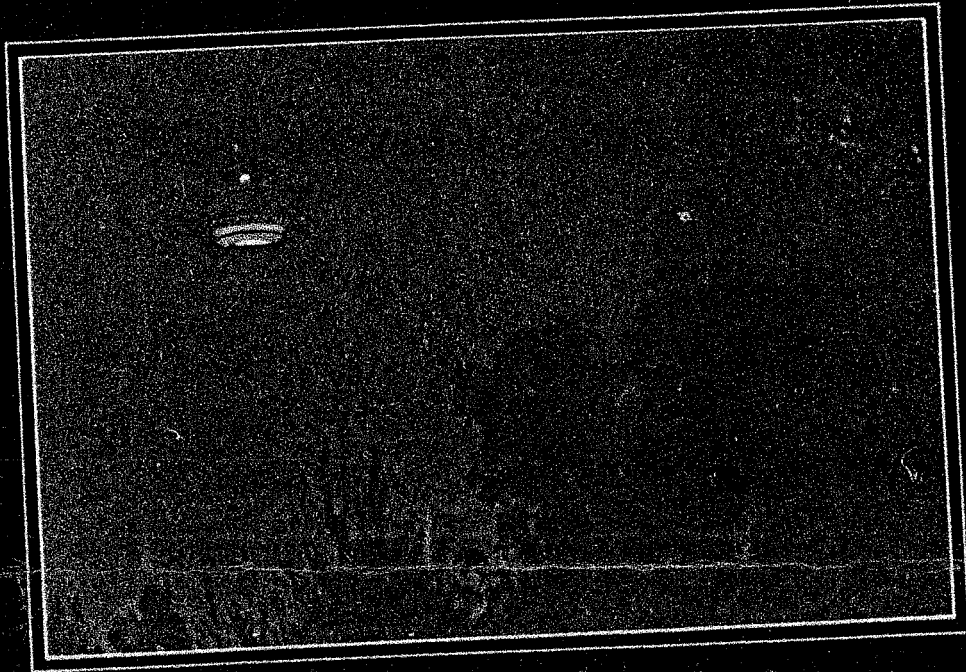

THE
UFO
REPORT
1990

EDITED BY
TIMOTHY GOOD
the author of **Above Top Secret**

THE UFO REPORT 1990

(involving physical evidence); 1,477 a CEIII (alien occupants seen); and an astonishing 2,969 witnesses who claimed to have been abducted by aliens (CEIV).²

On the programme, Paul Shartle, former security manager and chief of requirement for the audio-visual programme at Norton Air Force Base, California, revealed the existence of an official film taken at Holloman AFB, New Mexico, which allegedly shows a UFO landing and the occupants communicating with various personnel at the base. Interviewed with Shartle was the TV producer Robert Emenegger, who obtained the film via the Pentagon in the early 1970s when he was in the process of making a documentary on the subject. He had hoped to include the film in his documentary, but permission was suddenly withdrawn.

Two alleged US Government intelligence agents, 'Condor' and 'Falcon', appeared on the documentary, with their faces blacked out and voices electronically modulated. They confirmed the existence of the so-called 'Majestic-12' committee, established under President Truman in 1947, following the retrieval of an alien spacecraft and its dead occupants in the New Mexican desert (details of which were first published in *Above Top Secret*). They further revealed that there had been actual communication with a number of extraterrestrials.

All this could be disinformation, of course. And the obtrusive synthesized background music that pervaded the entire documentary did little to enhance the agents' credibility. None the less, I have been informed that their credentials, at least, are bona fide.

Many people have written to ask me if the Majestic-12 briefing document, prepared for President-elect Eisenhower by former CIA director Vice-Admiral Roscoe Hillenkoetter in November 1952, reproduced for the first time in *Above Top Secret*, is authentic. The document (which I obtained from a CIA source) received world-wide publicity in 1987, and lengthy articles appeared in such newspapers as the *Observer* and the *New York Times*. The document's authenticity has been questioned by the Dwight D. Eisenhower Library, the Harry S. Truman Library, and the National Archives, but a great deal of information has now surfaced which tends to indicate that it is genuine.

A 1954 top secret memorandum from presidential assistant Robert Cutler to the then Air Force Chief of Staff, General Nathan Twining, makes reference to the 'MJ-12 Special Studies

Project' in cc
16 July that y
USAF Intellig
indication tha

Dr Roger V
at Drew Uni
writing style c
be-authentic e
he stated as fo
reason to reg
to believe tha
Hillenkoetter.

This does no
Further resea
William Moor
appropriated l
can devote sev
there are some

Sightings by c
Chapter 5, Cy
the crew and j
plane, as well
1988.

Two days e
observed over
pilots and air
aircraft, includ
Oscar Botero,
area for half a
Cordova airpo
to the UFO, b
Avianca Boeir
was following
instead of land

Significantly
on the incident
permission fro
air traffic com
a fast-moving s

19 DEC 1989

Section 40
[REDACTED]

Reference: F89-1820

Dear Section 40
[REDACTED]

This is in response to your letter of 13 October 1989, which we did not receive until 29 November 1989, regarding your Freedom of Information Act (FOIA) requests F89-1506 and F89-1532.

The FOIA provides for public access to reasonably described records. This means that a document must be described sufficiently to enable a professional employee familiar with the subject to locate the document without an unreasonable amount of effort. This, with few exceptions, means that the documents must be locatable through the indexing to our various records systems. The FOIA does not require us to perform research or create records for a requester. Neither are we required to answer questions nor to study a body of material to see if any of it is related to a specific event, activity, or incident. Thus we are unable to assist you with a "correspondance address of NRO" nor any identification of "MAJESTIC 12" documents. You will recall that we have previously advised you that the only "MJ-12" (or whatever) document which was purported to be a CIA document was a obvious fake.

If you have reason to believe that supposedly "classified" information is being divulged by an individual who purports to be affiliated with the CIA, we would appreciate it if you would contact the Federal Bureau of Investigation (FBI) to report such ostensibly "illegal" activity. You should also be aware that impersonation of a Federal official is a Federal crime, and should also be reported to the FBI.

As to the balance of your request on "A-Bilderberg Group, B-Trilateral Commission, and C-Ditchley Park Foundation (U.S. Branch)," we call your attention to our letter of 4 October 1989 in response to your earlier FOIA request F89-1506. You will recall that the FOIA authorizes Federal agencies to collect fees for records services. We are enclosing, therefore, another copy of our fee schedule for your guidance. You will note that we charge search fees, including computer time where indices are computerized, and copying costs for releasable documents.

11 May 1988

Section 40

Dear Section 40

Sir, I have heard that you have written a book about the MJ-12 document. It is reported, however, that copies of your book that are sold in the United States are missing 168 pages of original information.

I would like to know just how I might obtain two autographed copies of your book (with the original pages); one for me and one for my friend Section 40 and how much they would cost (in U.S. currency)?

I would also like to resolve a puzzle-

Section 40 indicated to me that you were (like he) a "controlled informant" and that it was your function to release the MJ-12 document in England at the same time that he did in the U.S.

He reports now, however, that he "HAD" to release the MJ-12 document in the U.S. because you beat him to the punch by releasing the document in England. He says that he does not know where you got the document. He also tells me that some agency of my (the U.S.) government specifically told him to approach me to leak the MJ-12 document to the public and that even when I became fearful of circulating the thing "they" were circulating it in my name.

I would like to know the truth and just how you came to obtain a copy of the document?

I would also like to know if you have heard an more about the alleged USAF/Lockheed stealth fighter; specifically, has anyone seen it; photos, drawings?

Thank you for your time, Sir.

Sincerely,

Section 40

Monrovia, CA 91016 USA

ABOVE TOP SECRET

THE WORLDWIDE UFO COVER-UP

Section 40

Section 40

19 May 1988

☎ 0306 880669

Dear Section 40

11.V.88

Many thanks indeed for your letter and interesting enclosures on "Stealth" developments. But for heaven's sake, you don't need to address me as Section 40

ABOVE TOP SECRET is due to be published in its entirety - plus some important amendments and corrections - on 28 June, by William Morrow & Co. of New York, at \$19.95. I hope it will be widely available. I'm enclosing two stickers which I have autographed for you and Mr Ron Regehr.

~~Regarding MJ-12, what you say is accurate, to the best of my knowledge. However, there is nothing I can tell you - or anyone else - about how or from whom I obtained the document. I was given permission to reproduce the document in my book, which was first published in July last year. Since copies were available to the press at the end of May, it was impossible for me to stop them from publicizing the MJ-12 story.~~

I don't know any more about Stealth than you - and probably a lot less. The most interesting information I have read about the fighter/reconnaissance version appeared in the February issue of GUNG-HO. If you don't have this, I'll gladly send you a copy. I'm enclosing two very recent clippings about the Stealth bomber - the B-2 - from the International Herald Tribune and Time Magazine. The existence of this aircraft is, as you know, officially confirmed.

The clippings on Stealth that you sent me are most interesting. I do think that you should be careful when talking about your work with the press - or indeed anybody - since it is likely that details of the U-2 manufacture are still secret. I might be wrong about this, but anyway - take care.

~~Finally, please give my warmest regards to your wife.~~

Kind regards

Section 40

Encs: IHT, TIME, autographs

~~TOP SECRET~~
~~SECRET~~
THE WHITE HOUSE
WASHINGTON

September 24, 1947.

MEMORANDUM FOR THE SECRETARY OF DEFENSE

Dear Secretary Forrestal:

As per our recent conversation on this matter, you are hereby authorized to proceed with all due speed and caution upon your undertaking. Hereafter this matter shall be referred to only as Operation Majestic Twelve.

It continues to be my feeling that any future considerations relative to the ultimate disposition of this matter should rest solely with the Office of the President following appropriate discussions with yourself, Dr. Bush and the Director of Central Intelligence.

Harry Truman

~~TOP SECRET~~
~~SECRET~~

008

These documents ARE NOT DECLASSIFIED

ALL INFORMATION CONTAINED HEREIN IS UNCLASSIFIED

~~EYES ONLY~~

COPY ONE OF ONE.

NUMERATION OF ATTACHMENTS:

- *ATTACHMENT "A".....Special Classified Executive Order #092447. (TS/EO)
- *ATTACHMENT "B".....Operation Majestic-12 Status Report #1, Part A. 30 NOV '47. (TS-MAJIC/EO)
- *ATTACHMENT "C".....Operation Majestic-12 Status Report #1, Part B. 30 NOV '47. (TS-MAJIC/EO)
- *ATTACHMENT "D".....Operation Majestic-12 Preliminary Analytical Report. 19 SEP '47. (TS-MAJIC/EO)
- *ATTACHMENT "E".....Operation Majestic-12 Blue Team Report #5. 30 JUN '52. (TS-MAJIC/EO)
- *ATTACHMENT "F".....Operation Majestic-12 Status Report #2. 31 JAN '48. (TS-MAJIC/EO)
- *ATTACHMENT "G".....Operation Majestic-12 Contingency Plan MJ-1949-04P/78: 31 JAN '49. (TS-MAJIC/EO)
- *ATTACHMENT "H".....Operation Majestic-12, Maps and Photographs Folio (Extractions). (TS-MAJIC/EO)

~~TOP SECRET//SI//NF~~

~~EYES ONLY~~

T52-EXEMPT (B)

~~TOP SECRET~~

COPY ONE OF ONE.

A need for as much additional information as possible about these craft, their performance characteristics and their purpose led to the undertaking known as U.S. Air Force Project SIGM in December, 1947. In order to preserve security, liason between SIGM and Majestic-12 was limited to two individuals within the Intelligence Division of Air Materiel Command whose role was to pass along certain types of information through channels. SIGM evolved into Project GRUDGE in December, 1948. The operation is currently being conducted under the code name BLUE BOOK, with liason maintained through the Air Force officer who is head of the project.

On 06 December, 1950, a second object, probably of similar origin, impacted the earth at high speed in the El Indio - Guerrero area of the Texas - Mexican border after following a long trajectory through the atmosphere. By the time a search team arrived, what remained of the object had been almost totally incinerated. Such material as could be recovered was transported to the A.F.C. facility at Sandia, New Mexico, for study.

Implications for the National Security are of continuing importance in that the motives and ultimate intentions of these visitors remain completely unknown. In addition, a significant upsurge in the surveillance activity of these craft beginning in May and continuing through the autumn of this year has caused considerable concern that new developments may be imminent. It is for these reasons, as well as the obvious international and technological considerations and the ultimate need to avoid a public panic at all costs, that the Majestic-12 Group remains of the unanimous opinion that imposition of the strictest security precautions should continue without interruption into the new administration. At the same time, contingency plan MJ-1949-04P/78 (Top Secret - Eyes Only) should be held in continued readiness should the need to make a public announcement present itself. (See Attachment "G".)

~~TOP SECRET~~~~EYES ONLY~~

T52-EXEMPT (E)

00

~~TOP SECRET~~
.....
~~TOP SECRET~~
.....
COPY ONE OF ONE.

A covert analytical effort organized by Gen. Twining and Dr. Bush acting on the direct orders of the President, resulted in a preliminary consensus (19 September, 1947) that the disc was most likely a short range reconnaissance craft. This conclusion was based for the most part on the craft's size and the apparent lack of any identifiable provisioning. (See Attachment "D".) A similar analysis of the four dead occupants was arranged by Dr. Bronk. It was the tentative conclusion of this group (30 November, 1947) that although these creatures are human-like in appearance, the biological and evolutionary processes responsible for their development has apparently been quite different from those observed or postulated in homo-sapiens. Dr. Bronk's team has suggested the term "Extra-terrestrial Biological Entities", or "ETBEs", be adopted as the standard term of reference for these creatures until such time as a more definitive designation can be agreed upon.

Since it is virtually certain that these craft do not originate in any country on earth, considerable speculation has centered around what their point of origin might be and how they got here. Mars was and remains a possibility, although some scientists, most notably Dr. Menzel, consider it more likely that we are dealing with beings from another solar system entirely.

Numerous examples of what appear to be a form of writing were found in the wreckage. Efforts to decipher these have remained largely unsuccessful. (See Attachment "E".) Equally unsuccessful have been efforts to determine the method of propulsion or the nature or method of transmission of the power source involved. Research along these lines has been complicated by the complete absence of identifiable wings, propellers, jets, or other conventional methods of propulsion and guidance, as well as a total lack of metallic wiring, vacuum tubes, or similar recognizable electronic components. (See Attachment "F".) It is assumed that the propulsion unit was completely destroyed by the explosion which caused the crash.

~~TOP SECRET~~

T52-EXEMPT (E)

~~TOP SECRET~~

04

Top Secret is the
arches. Timothy Go
inist.

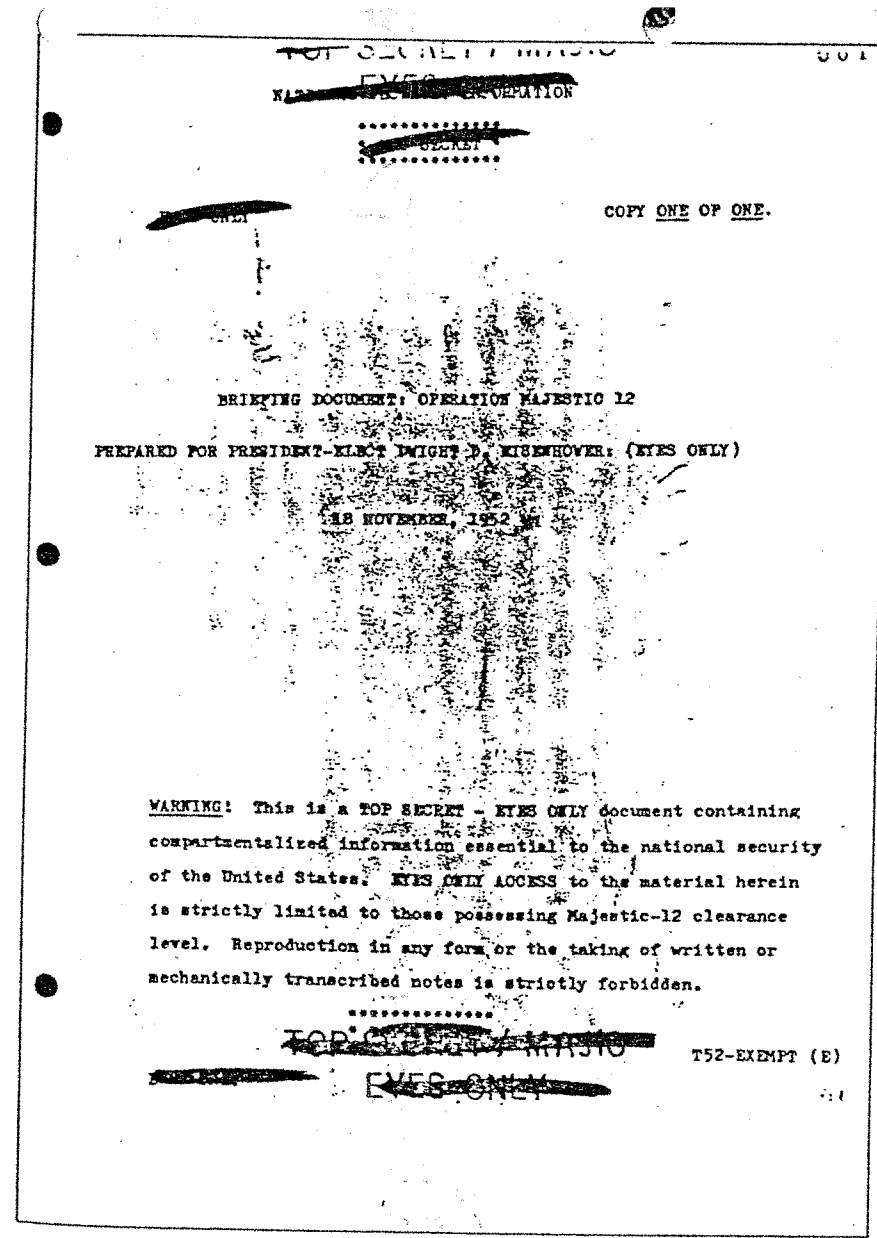

TOP SECRET - MASTO
EYES ONLY
OPERATION MAJESTIC 12
18 NOVEMBER, 1952

WARNING: This is a TOP SECRET - EYES ONLY document containing compartmentalized information essential to the national security of the United States. EYES ONLY ACCESS to the material herein is strictly limited to those possessing Majestic-12 clearance level. Reproduction in any form or the taking of written or mechanically transcribed notes is strictly forbidden.

TOP SECRET - MASTO
EYES ONLY
T52-EXEMPT (E)

re from the Majestic-12 briefing document Eisenhower in November 1952, hitherto AJIC - EYES ONLY. They were made in early 1987, before their release by the

one of the eight attachments - Attachment , this being the Special Classified Executive 1 Majestic 12, signed by President Truman that further details will have been released et is published.

with; who replaced James Forrestal (MJ-3) ctor of Central Intelligence in October that at successive DCI's - who head the entire ell as the CIA - are automatically assigned ; logical to assume that each President is taking office. According to the Air Force ons document dated November 1980, (see ill functioning that year, and I have been lthough probably under a different name. tual alien bodies were recovered during is of course sensational news. Until the s document was made available, it was by were found following the retrieval of UFO orth-west of Roswell, New Mexico, in July n to have seen dead bodies beside a crashed ariance with the MJ-12 version of events, ther crash (see Chapter 11).

ble is the fact that the United States author- es - as well as UFO wreckage - in their e seen whether further details, including ope? - actual exhibits from the Roswell eged to have taken place (see Chapter 16), ll they remain classified - above Top Secret?

152-EXHIBIT (B)

~~SECRET~~
~~CONFIDENTIAL~~

The death of Secretary Forrestal on 22 May, 1949, created a vacancy which remained unfilled until 31 August, 1950, upon which date Gen. Walter B. Smith was designated as permanent replacement.

- Adm. Roscoe H. Hillenkoetter
- Dr. Vannevar Bush
- Gen. Nathan F. Twining
- Gen. Hoyt H. Vandenberg
- Dr. Dettler Bronk
- Dr. Jerome Hunsaker
- Mr. Sidney A. Bowens
- Mr. Gordon Gray
- Dr. Donald Kennel
- Gen. Robert M. Montgomery
- Dr. Lloyd A. Berkner

Members of the Majestic-12 Group were designated as follows: Dr. Vannevar Bush and Secretary James Forrestal. (See Attachment President Truman on 24 September, 1947, upon recommendation by which was established by special executive order of the President of the United States. Operations of the project are Intelligence operation responsible directly and only to the OPERATION MAJESTIC-12 is a TOP SECRET Research and Development/

NOTE: This document has been prepared as a preliminary briefing document only. It should be regarded as introductory to a full operations briefing intended to follow.

SUBJECT: OPERATION MAJESTIC-12 PRELIMINARY BRIEFING FOR PRESIDENT-ELITE MEMBERS.
DOCUMENT PREPARED 18 NOVEMBER, 1952.
BRIEFING OFFICER: ADM. ROSCOE H. HILLENKOTTER (M-1)

COPY ONE OF ONE

~~SECRET~~
~~CONFIDENTIAL~~

Timothy Good has broadcast and lectured on his subject for several years and is the author of one previous book. *Above Top Secret* is the synthesis of all his previous researches. Timothy Good is also a professional violinist.

COPY ONE OF ONE.

On 24 June, 1947, a civilian pilot flying over the Cascade Mountains in the State of Washington observed nine flying disc-shaped aircraft traveling in formation at a high rate of speed. Although this was not the first known sighting of such objects, it was the first to win widespread attention in the public media. Hundreds of reports of sightings of similar objects followed. Many of these came from highly credible military and civilian sources. These reports resulted in independent efforts by several different elements of the military to ascertain the nature and purpose of these objects in the interests of national defense. A number of witnesses were interviewed and there were several unsuccessful attempts to utilize aircraft in efforts to pursue reported discs in flight. Public reaction bordered on near hysteria at times.

In spite of these efforts, little of substance was learned about the objects until a local rancher reported that one had crashed in a remote region of New Mexico located approximately seventy-five miles northwest of Roswell Army Air Base (now Walker Field).

On 17 July, 1947, a secret operation was begun to assure recovery of the wreckage of this object for scientific study. During the course of this operation, aerial reconnaissance discovered that four small human-like beings had apparently ejected from the craft at some point before it exploded. These had fallen to earth about two miles east of the wreckage site. All four were dead and badly decomposed due to action by predators and exposure to the elements during the approach. A special scientific team took charge of removing these bodies for study. (See Attachment "G.") The wreckage of the craft was also removed to several different locations (See Attachment "H.") Civilian and military witnesses in the area were debriefed, and news reporters were given the effective cover story that the object had been a mislaunched weather research balloon.

152-EXHPT (E)

EXHPT ONLY
 TOP SECRET

Way

19 FEBRUARY 1990

Dear Sirs,

I have corresponded with you several times with regard to my interest in the subject of Unidentified Flying Objects (UFO's). In your letter of 28 March 1989 it was stated that you could answer specific queries about particular incidents which have occurred recently.

My reason for writing is to enquire if it is possible to obtain copies of any reports relating to 3 sightings. According to recent press reports details were forwarded to MOD and/or Air Force.

X 1) Report in 'ADSCENE' week ending Friday 17th November 1989 of a sighting over Canterbury, specifically in the Waltham area. According to the press report a witness was asked to fill in a report by the local police which was forwarded to RAF MANSTON.

X 2) A sighting reported in the 'Herne Bay Gazette' of 13 Oct. 1989 regarding a sighting made by a BELTINGE woman. According to the press report Kent International Airport stated that the MOD would be informed.

X 3) A report in the 'Evening Sentinel' newspaper of Stoke On Trent dated 7 December 1989. This refers to a sighting by police officers from Kidsgrove. This report states that the MOD had been informed.

Should you be able to supply copies of any relevant reports I would be very pleased to hear from you. Thank you for taking the time to read my letter.

Yours Sincerely,

File. 12/3

ENCL No
28/11

Section 40

phoned to ask whether we were doing anything about the TOP SECRET 'Majestic 12' documents from the CIA in US. He asked whether it was against the law to publish such documents in the UK. When I replied that I had no idea he told me that he had reported the matter to the US Embassy for onward transmission to the FBI. I then intimated that this was really nothing to do with us and he rang off.

Section 40

Section 40

16/2/90

Since the book was published ages ago I fail to see why [redacted] is getting so excited.

Section 40

(H) ENCL No. 28

MEMORANDUM

MOD Form 4A

To Section 40
AA/US of S (AF)
Room Section 40
Main Building
Date 16 Feb 90
Your ref. ADG/CA/3283

From Sec(AS)2a
Room Section 40
Main Building
Tel. Section 40
Our ref. D/Sec(AS) 12/3

Subject OUTER SPACE ACT 1986

I attach a copy of my note of 25 Jan 90 in which I told you that the matter had been passed to the DTI for action. I attach also your note of 15 Feb 90.

Rank/ Appointment E0 Name in Block Letters Section 40 Signature Section 40



Department of the Environment

Room Section 40

Romney House 43 Marsham Street London SW1P 3PY

Direct line Section 40
Switchboard G

ENCLOSURE No. 27

Section 40

Sec (AS) 2a
MOD
Main Building
Whitehall

Your reference

Our reference

Date 13/2/90

Dear Section 40

LETTERS FROM THE PUBLIC

I enclose copies of the replies I have sent to

Section 40

and pupils from
Dame Alice Owen's School.

Yours Sincerely

Section 40

Global Atmosphere Division



DEPARTMENT OF THE ENVIRONMENT

Room **Section 40**

Romney House 43 Marsham Street London SW1P 3PY

Telex 22224

Direct Line **Section 40**
Switchboard
GTN

Section 40

Your reference

Our reference

Date 13 February 1990

Dear

Section 40

Thank you for your letter, and those of your pupils, to the Prime Minister. I have been asked to reply and must apologise for the delay in doing so.

I enclose replies to two of your pupils, **Section 40** and **Section 40**. **Section 40** I understand the Ministry of Defence has replied to **Section 40**. I hope **Section 40** and their classmates will find the leaflets of interest.

My colleagues in this division are concerned with climate change and have issued a booklet on the subject. I enclose a copy which you may find useful for classwork on the environment.

Section 40

Global Atmosphere Division



DEPARTMENT OF THE ENVIRONMENT

Room **Section 40**

Romney House 43 Marsham Street London SW1P 3PY

Telex **Section 40**

Direct Line **Section 40**
Switchboard
GTN

Section 40

Your reference

Our reference

Date 13 February 1990

Dear

Section 40

Thank you for your letter of 7 October 1989 to the Prime Minister, about the need to safeguard the ozone layer which protects the earth from harmful ultra-violet radiation. I have been asked to reply and apologise for the long delay in doing so.

Recent scientific evidence has shown that chlorofluorocarbons or CFCs (man-made compounds containing chlorine, fluorine and carbon) are responsible for the serious reduction of ozone in the upper atmosphere. As a result of this evidence an international agreement, the Montreal Protocol on Substances that Deplete the Ozone Layer, was agreed in 1987 to limit the production and consumption of CFCs and some other ozone depleting chemicals called halons.

Since 1987 new evidence has shown that the Protocol is not good enough. In March last year, the Prime Minister held the "Saving the Ozone Layer" Conference which was attended by representatives from 123 countries. It was generally agreed that production and consumption of CFCs and halons should be phased out.

In June this year the countries who are Parties to the Montreal Protocol are to meet in London to negotiate a strengthening of the Protocol. The UK, EC, and many other countries will be arguing for CFC production and consumption to be phased out by the year 2000.

You were asking for aerosol use to stop. In 1986 aerosols represented 62% of the UK's CFC use; by the end of last year 90% of aerosols were CFC-free. The remaining 10% are applications where safe alternatives have not yet been found, such as a replacement for CFCs in asthma inhalers.

I hope this reassures you that the Government is doing a great deal to reduce the amount of CFCs released to the atmosphere. I enclose leaflets on the ozone layer and air quality which you may find of interest.

Section 40



Global Atmosphere Division



DEPARTMENT OF THE ENVIRONMENT

Room **Section 40**
Romney House 43 Marsham Street London SW1P 3PY

Telex **Section 40**

Direct Line **Section 40**
Switchboard
GTN

Your reference

Our reference

Date

13 February 1990

Section 40

Dear

Section 40

Thank you for your letter of 9 October 1989 to the Prime Minister. I have been asked to reply and apologise for the long delay in doing so.

First of all, regarding the landing of aliens on earth, I have consulted the Ministry of Defence who confirm that they have yet to receive any positive evidence to suggest that alien craft have landed on the planet.

Turning to your concerns about air pollution, I enclose some leaflets on air pollution and the steps we are taking to improve air quality. I hope you find these of interest.

Yours Sincerely

Section 40

Section 40

Global Atmosphere Division

ENCL No. 26

MEMORANDUM

MOD Form 4A

To Section 40
CS(R) 1

From See (AS) 2a
Room Section 40
Main Bdg

Date 13th February, 1990

Tel. Section 40 M.B.

Your ref.

Our ref. D/Sec (MS) 12/3

Subject LETTERS FROM Section 40

As promised in our telephone conversation this morning, I attach correspondence See (AS) has had with Section 40. As you will see, he is a frequent correspondent, to put it mildly! I fear that he will interpret whatever he is told as part of the 'conspiracy of silence'. If your reply to him merely produces more of the same in return, please pass the letters to us. It might help in blacklisting proceedings should they be felt necessary. A copy of Section 40 letter to you would be appreciated.

Rank/
Appointment AD

Name in
Block Letters Section 40

Signature Section 40

ENCL N.P.
25

to:

Phone call from [Section 40] in CS(R)1, regarding

pendence from [Section 40]. Some months

, I asked CS(R)1 to write a letter to [Section 40]

[Section 40] (another regular) explaining the Public Records

[Section 40] has apparently copied that letter to

[Section 40], who has written a typically abusive

note to CS(R)1. They are prepared to write to

on this occasion, but I have suggested that

it looks like a protracted correspondence they

should pass all mail to us to handle. Meanwhile,

am copying our most recent correspondence with

M, and our standard paragraphs to CS(R)1.

[Section 40] 13/2.

5 part F



LOOSE MINUTE

D/CG&DGSy(RAF)/68/2/1

12 Feb 90

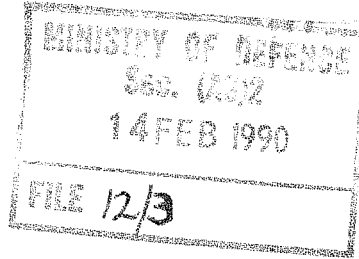

Sec(AS)2a

Copy to:

DI 55
DD MOD Sy
DDGE/AEW

Section 40 [redacted] - UFO CORRESPONDENT

Reference:

A. D/Sec(AS)12/3 dated 17 Jan 90.

1. At Reference A you asked for advice regarding activities and background. Enquiries were tasked to the appropriate RAF P&SS Region.

Section 40 [redacted]

Section 40 [redacted]

nothing else of an adverse political, security or criminal connection is recorded.

Section 40 [redacted]

Sqn Ldr
PM1a(RAF)

Section 40 [redacted]

9/2/90

Section 40

1-20
2k

F44 1JQ

Dear [Section 40]

I recieved your letter dated 29 Jan 1990, I find the letter very lacking on the commital side, Regards the F3 Tornado firing a air to air missile at a Unidentified air craft, Is it normal policy to allow one of her Majesty's R A F fighters to carry out such antics over a highly populated area, ie Blackpool, If so I think there should be a general inquiry made, I'm sure the populace of this NW coastal town would find it very interesting to know, that a pilot has the authority to take it upon himself to blow up anything he sees fit to do so.

I hope for a more informed statement from you regarding this matter, Did a F3 Tornado take off on that night,

yours sincerely

[Section 40]

MUFORA

ENCL No 2

MINISTRY OF DEFENCE
Sec. (S)2
- 6 FEB 1990
FILE

SUBJECT : U.F.O.'s.

.....
Unidentified
Flying
Objects.
.....

Section 40
[Redacted]

/ 2 / 1990.

TEL / Section 40

Dear Sirs,

I am sending this letter in order to request information regarding a 'UFO Incident' in which a Section 40 Tri-star was involved, en-route from Malta to Gatwick Airport, on, 21 - March- 1989 ? .

And also, the following 'UFO Incident' which involved the American 'Space-Shuttle, Discovery' , on the ,13-March-1989, do you have any detailed information regarding this incident ? , on file ? .

There is not much difference in the dates of the above incidents, could it be the same Object involved , or , UFO ?

I am of the belief ,or firm conviction that these UFO incidents were subjected to an attempted , ' Cover - up ' , but then failed,due to wide press coverage.

* For your interest,I have enclosed a Copy of an cassette recording of the above incidents, as they happened at the time. The Tristar incident, firstly,is mentioned, then followed by the , 'Space-Shuttle' incident, on side - A , of the tape. This may be of help !

Yours Sincerely,

Section 40
[Redacted]

MINISTRY OF DEFENCE
Sec. (AS)2
- 7 FEB 1990

ENCLOSURE
22

Section 40

Secretariat (Staff) Ca
Room Section 40
Ministry Of Defence,
Main Building Whitehall,
London, SW1A 2HB

Section 40

Date: Feb. 2nd, 1990
Ref: 90-0202/2

Dear Section 40

This is in response to your letter dated 30 JAN 1990, D/Sec(AS)12/3.

Although your letter was somehow more coherent comparing with your previous letter, however, there are areas which you have not provided qualified answers to my questions put to MOD.

Not what he says in his letter to CS(R)A

Not answering

Not answering

Not answering

Not answering

- / 1. Reference is the third paragraph in your recent letter. Is it or is it not correct that the police force in UK would pass any reports where MOD is involved to you? In other words one is trapped in a circle where starts off with MOD, police acts as a conduit, and ends up with MOD. Hence, why you are not prepared to answer a legitimate question? I do not believe, and neither do you that the visitors, who show a great skill and knowledge about various departments in MOD (Many times unknown to the public, and verified in latter day upon careful inquiries) could possibly be imposters.
- / 2. I am pleased to hear at last that the UFO reports (From the civilian public or the military establishments) are passed on to the appropriate departments in MOD. Could you please tell us which particular departments are in charge of dealing with a subject which a. does not constitute a national threat, b. is unclassified. I would require a list of those departments.
- 3. Could you please qualify for me, since what date, the MOD discovered that the UFOs are not a national threat. If this is genuinely the case why even after the thirty year legal time, there are no reports of the sightings available to the public in the Publics Records Office?
- 4. I repeat herewith my previous request. Could MOD prove by furnishing me with a copy of the Official Findings Report and the scientific analysis that UFOs are not a national threat?
- 5. Could MOD confirm whether has used or consulted with an English born Section 40 in any aspect/s relating to UFOs, or the product of the findings derivative of UFOs in connection with any MOD project?
- 6. Could MOD say what is known on the element 115?
- 7. Could MOD provide me with a copy of the last two reports in 1989 for my research?
- 8. Could you please tell me what is the function of Airspace Intelligence in connection with UFOs.

Finally, commenting on your fourth paragraph. I do not think you would
refute the presence of Naval Intelligence in such cases.

Yours sincerely, *o f*

Section 40

A large black rectangular redaction box covers the signature area, obscuring the name and any handwritten notes.

MOD



Section 40

TEL : Section 40

24.1.90

DEAR SIR/MADAM,

I AM CURRENTLY INVESTIGATING THE SIGHTING OF AN UNIDENTIFIED FLYING OBJECT ON THE 8th JANUARY 1990 AT 20.45 HRS NR BROWN CANOVER, NORTH OF ALSFORD.

CAN YOU PLEASE SUPPLY ME WITH THE FOLLOWING DETAILS :

1. WERE ANY OTHER REPORTS FILED WITH YOU CONCERNING U.F.O SIGHTINGS FOR THE DAY IN QUESTION.
2. WERE ANY MILITARY AIRCRAFT, TO YOUR KNOWLEDGE, IN THE AREA AT THE TIME.
3. CAN YOU PLEASE CONFIRM, IF ANY KNOWN AIRCRAFT ARE ALLOWED TO CARRY TWO LARGE 'HEADLIGHT' TYPE OF LIGHTS FRONT & BACK.

ANY HELP WITH THE ABOVE QUESTIONS WOULD BE GREATFULLY RECEIVED.

YOURS FAITHFULLY,

Section 40

MINISTRY OF DEFENCE

Room Section 40

Main Building Whitehall London SW1A 2HB

Telephone (Direct Dialling) Section 40 ext
(Switchboard)

Section 40

Your reference

Our reference

D/Sec(AS)12/3

Date

31 January 1990

Dear

Section 40

Thank you for your report to RAF Finningley of an unusual sighting you witnessed on 15 January, which has been passed to the Ministry of Defence for reply.

It may be helpful if I begin by explaining that while the Ministry of Defence does receive and co-ordinate some reports of UFO sightings, our sole concern is to determine whether or not they present a threat to the security of the United Kingdom. Unless we judge that they do, and this has not been the case so far, we do not attempt to investigate further, or to identify whatever might have been seen.

Given this limited involvement with the subject, the Ministry of Defence does not have any department which is appointed solely for the purpose of investigating UFO reports, nor do we have any staff employed on the subject full time. As you will expect, therefore, we do not carry out studies, investigations or surveys into the phenomenon. I am sure you will appreciate that Defence funds are already fully committed to maintaining the security of the UK against, primarily, aggression from the Warsaw Pact countries. This being so, we could not justify the use of defence funds on scientific investigations unless a clear threat to security had been identified.

In this context, I regret that I am unable to offer a definitive explanation for what you witnessed. I hope you will accept that because no threat has been established, the Ministry of Defence will not be investigating. Nevertheless, we are grateful to you for taking the time to make a report.

I hope that you will find this helpful.

Yours sincerely,

Section 40



MINISTRY OF DEFENCE

Main Building Whitehall London SW1A 2HB

Telephone: (Direct Dialling) **Section 40**
(Switchboard)



Section 40

Your reference

Our reference

D/Sec(AS)12/3

Date

30 January 1990

Dear

Section 40

Thank you for your letter of 19 January on the subject of Unidentified Flying Objects.

I think it would be most helpful if I begin by reminding you that the MoD has no department which is appointed solely for the purpose of studying reports of UFOs and we have no staff who are employed on the subject full time. As I stated in my letter of 17 January, we do not carry out studies into the UFO phenomenon and could not justify the use of defence resources to conduct investigations unless a clear threat to the security of the UK has been identified. With this in mind I hope that you will understand that the amount of time and effort that can be spent searching for past UFO reports is constrained and it is not possible to commit scarce resources in conducting searches for a report, made over seventeen years ago, of the incident you describe.

I shall not comment on your suggestion that MoD personnel have visited members of the public regarding UFO sightings other than to say that it is not our practise to interview people in connection with UFO sightings. If members of the public are visited by people claiming to be MoD 'investigators' I would suggest that they take the matter up with the police, who are the proper body to deal with such imposture.

I find your claim that there is a Rear Admiral present 'in almost every major UFO incident in any of the RAF bases' incredible. I consider such a possibility would be extremely unlikely.

I can confirm that the sighting reports that we receive, which are usually limited to the brief details passed on to us by those who witnessed them are referred to our staff in the departments which are responsible for the air defence of the United Kingdom, and they examine the reports as part of their normal duties.

I can also tell you that the number of UFO reports received by ourselves for the years 1988 and 1989 were 397 and 258, respectively.

Finally, in relation to the postscript to your letter of 19 January, I have no knowledge of any organisation within the MoD called the 'Special Petrol Group'

I hope that this has been of some help.

Yours sincerely,

Section 40

From: Section 40, Secretariat (Air Staff)2a, Room Section 40



MINISTRY OF DEFENCE

Main Building Whitehall London SW1A 2HB

Telephone: (Direct Dialing) **Section 40**
(Switchboard)



Section 40

Your reference

Our reference

D/Sec(AS)12/3

Date

29 January 1990

Section 40

Dear

Thank you for your report of an unusual sighting you witnessed on 21 December 1989, which has been passed to the Ministry of Defence for reply.

You may find it helpful if I begin by explaining that while the Ministry of Defence does receive and co-ordinate some reports of UFO sightings, our sole concern is to determine whether or not they present a threat to the security of the United Kingdom. Unless we judge that they do, and this has not been the case so far, we do not attempt to investigate further or identify what might have been seen.

Given this limited involvement with the subject, the Ministry of Defence does not have any department which is appointed solely for the purpose of studying UFO reports, nor do we have any staff employed on the subject full time. As you will expect, therefore, we do not carry out studies, investigations or surveys into the phenomena. I am sure you will appreciate that defence funds are already fully committed to maintaining the security of the UK, and this being so, we could not justify the use of funds on scientific investigations, unless a clear threat to security had been identified.

Nonetheless, it is clear from the reports we receive that many strange things have been observed in the sky, although we believe that rational explanations could be found for most of them. Possibilities include satellite debris re-entering the earth's atmosphere, ball lightning, unusual cloud formations, meteorological balloons, aircraft lights, aircraft at unusual angles or a host of other things. In this case, however, I have ascertained that significant helicopter activity did take place in the vicinity of Aldergrove Airport on the date, and at the approximate time of your sighting. It is highly possible that what you saw was helicopter movements taking place in the area.

Thank you for taking the time to make a report, I hope that you have found this helpful.

Yours sincerely,

Section 40

From: Section 40

Secretariat (Air Staff)2a, Room

Section 40

From: Section 40

Secretariat (Air Staff)2a



MINISTRY OF DEFENCE Room Section 40

Main Building Whitehall London SW1A 2HB

Telephone (Direct Dialling Section 40 ext 2038
(Switchboard)



Section 40

Your reference

Our reference

D/Sec(AS)12/3

Date

29 January 1990

Dear

Section 40

Thank you for your letter of 27th December 1989 on the subject of an unusual sighting witnessed on 5th July 1989 in Blackpool. We have also received your earlier letters to RAF Rudloe Manor and RAF West Drayton on this subject. I hope you will accept this letter as the reply to all three.

As you will be aware from our previous correspondence, the Ministry of Defence has a very limited involvement with this subject. As far as the incident on 5th July is concerned, I regret that I have been unable to establish whether or not RAF aircraft were in the area at the time in question. However, given the lateness of the hour, I would consider this unlikely. I can confirm that the Ministry of Defence did not receive any reports similar to this.

Turning to your other request for information from RAF West Drayton, concerning a series of incidents on 10th June 1989, we have already established from an earlier enquiry that no RAF exercises were going on in the area at that time. As no investigation of these incidents has been undertaken by the Ministry of Defence, I am unable to offer a definitive explanation for what was witnessed. Once again, no reports similar to this one were received.

I hope you will find this helpful.

Yours sincerely,

Section 40

91
EMERGENCY

MEMORANDUM

MOD Form 4A

To Section 40
AA/US of S(AF)
Room Section 40
Main Building
Date 25.1.90
Your ref. ADG/OA/100/3283

From Section 40
Sec(AS)2a
Room Section 40
Main Building
Tel. MB2140
Our ref. D/sec(AS) 12/3

Subject LETTER FROM Section 40 - OUTER SPACE ACT 1986

1. A letter from Section 40 regarding the 1986 Outer-Space Act was passed by yourself to Sec(AS) for action.
2. As the legislation was introduced to the commons by the Secretary of State for Trade and Industry, it is a matter for his Department to deal with.
3. Consequently, with their agreement, I have passed the letter over to the Minister for Industry and Enterprise's office for action.

FROM: Section 40 Sec(AS)2a, Room Section 40
Main Building, London SW1A 2HB



with the compliments of
MINISTRY OF DEFENCE

To: Ps/Minister for Industry and Enterprise

The OUTER SPACE ACT 1986

We spoke today regarding the attached letter from a member of the public which had been passed to me by US of S(AF)'s office. As discussed I attach it for your attention and that of the British National Space Centre.

Section 40

(25.1.90)

MOD FORM 195

Rank/ Appointment

EO

Name in Block Letters

Section 40

Signature

Section 40

OUR REF: ADG/OA/100/ 3283

..... Sect(A5) 2

The attached letter from Section 40
..... is forwarded to you for official
action. this letter has/~~has~~ not been acknowledged from this
office. The Minister attaches great importance in prompt replies
to correspondence he receives and would like this letter answered
by COP 7/2/90, or alternatively, if a delay
is anticipated, an interim reply should be forwarded, preferably
within the same timescale.

Would you please let us see a copy of your reply quoting our
reference. If this correspondence is transferred, then this office
must be notified.

Section 40
[Redacted]

24 JAN 1990
.....

Section 40
AA/US of S(AF)
Section 40

23 JAN 1990

Section 40

OF 100/3283

Sec CAS - CA

22-1-90

Dear Sir,

Re: OUTER SPACE ACT 1986

Quite by accident I came across the above statute. Section 7(3) states that a "Register of Space Objects" is kept by your office and that it will be made available on payment of a prescribed fee yet to be determined.

I should therefore be most grateful if you could advise me whether or not the fee has yet been set and how I may obtain a copy of the Register.

Yours sincerely,

Section 40

Public Information Office House of Commons London SW1A 0AA



4272

F A C S I M I L E T R A N S M I S S I O N

25.1.90

The following item is sent at the request

of

Section 40 [Redacted]

in

Ministry of Defence Sec. (AF)

If you should wish to contact us about
this, ask for

Section 40 [Redacted]

Section 40 [Redacted]

No. of Pages, including coversheet, to be
transmitted -

5

98/582/86
Sessions

NORTHERN IRELAND (LOANS) Mr T King/Lord Lyell (Government)
 A) Commons: (1) 1R: 7.11 2R: 27.11 Remaining stages: 4.12
 Lords: (35) 1R: 5.12 All stages: 19.12 Royal Assent (cap 76, 1985): 19.12

OBSCENE PUBLICATIONS (PROTECTION OF CHILDREN, ETC) (AMENDMENT) Mr W Churchill
 W) Commons: (21,105) 1R: 4.12 2R: 24.1 Comm (SC C): 19.2-12.3
 Rep: 25.4 & 4.7 (debates adjourned)

OPPORTUNITIES FOR YOUNG PEOPLE Mr D Steel
 Y) Commons: (114) 1R: 19.3 (not printed)

ORGAN DONOR CARDS Mr G Lofthouse
 Y) Commons: (228) 1R: 4.11 (not printed)

OSTEOPATHS Mr R Calley
 X) Commons: (218) 1R: 23.7

OUTER SPACE (HL) Lord Lucas of Chilworth/Mr P Channon (Government)
 A) Lords: (57,211) 1R: 23.1 2R: 4.2 OCD: *24.2 3R: *3.3 CA: *16.7
 Commons: (99,183) 1R: 3.3 SRC: 26.3 2R: *8.4 Comm (SC H): 17.6
 Rep and 3R: *3.7 Royal Assent (cap 38, 1986): 18.7

OWNERSHIP OF THE MEDIA Mr T Lloyd
 Y) Commons: (128) 1R: 9.4

PARLIAMENT (HL) Lord Perry of Walton
 Z) Lords: (77) 1R: 11.2 2R: 12.3

PARLIAMENTARY CONSTITUENCIES (HL) Lord Chancellor/Sir M Havers
 B) Lords: (172) 1R: 2.6 2R: *16.6 OCD: *1.7 3R: *3.7
 Commons: (200) 1R: 7.7 All stages: *24.10 Royal Assent (cap 56, 1986): 7.11

PATENTS, DESIGNS AND MARKS (HL) Lord Lucas of Chilworth/Mr P Channon (Government)
 A) Lords: (52,128,140,221) 1R: 16.1 2R: 3.2 Comm: 14 & 15.4 Rep: 22.4 3R: *29.4
 CA: 17.7
 Commons: (155,189) 1R: 1.5 SRC: 11.6 2R: *16.6 Comm (SC D): 26.6
 Rep & 3R: 8.7 Royal Assent (cap 39, 1986): 15.7

PEACE TAX Mr D Canavan
 Y) Commons: (124) 1R: 26.3

PENSIONERS' RIGHT TO HEAT, LIGHT AND COMMUNICATIONS Mr J Corbyn
 Y) Commons: (53) 1R: 18.12

PEOPLE'S RIGHT TO BUY Mr P Channon

PIG SLURRY (CONTROL) Mrs E Shields
 Y) Commons: (223) 1R: 28.10

POLICE COMPLAINTS PROCEDURE (AMENDMENT) Mr P Pike
 Y) Commons: (138) 1R: 22.4 Bill withdrawn: 22.5 (not printed)

POLICE COMPLAINTS PROCEDURE (AMENDMENT) (No 2) Mr P Pike
 X) Commons: (166) 1R: 22.5

POLITICAL PARTIES (INCOME AND EXPENDITURE) Mr D Winnick
 Y) Commons: (147) 1R: 29.4

PREVENTION OF OIL POLLUTION (HL) Lord Welton/Mr H Moate
 Z) Lords: (23,60) 1R: 28.11 2R: 16.12 Comm: 28.1 Rep: *4.2 3R: *11.2
 Commons: (85) 1R: 12.2 2R & Comm: *21.2 Rep & 3R: *28.2
 Royal Assent (cap 6, 1986): 18.3

[PROHIBITION OF PLASTIC BULLETS PROPOSED BILL]
 Commons: Motion to bring in negatived: 7.57

PROTECTION OF ANIMALS ACT 1911 (AMENDMENT) Mr K McNamara
 Y) Commons: (82) 1R: 12.2

PROTECTION OF CHILDREN (TOBACCO) Mr J Home-Robertson/Lord Pitt of Hampstead
 (Title changed from Tobacco Products (Sales Restriction))
 W) Commons: (71,175,186) 1R: 4.12 2R: 21.1 Comm (SC C): 26.7 Rep & 3R: 19.4
 LA: 4.7
 Lords: (137,197,203) 1R: 22.4 2R: 2.6 Comm: 19.6 Rep: 26.6 3R: *1.7
 Royal Assent (cap 34, 1986): 8.7

PROTECTION OF MILITARY REMAINS Mr M Mates/Lord Sandford
 W) Commons: (30,191) 1R: 4.12 2R: 31.1 MR: *4.2 Remaining Stages: 7.2
 LA: 4.7
 Lords: (75,173) 1R: 10.2 2R: 17.4 Comm: 3.6 Rep: *19.6 3R: *30.6
 Royal Assent (cap 35, 1986): 8.7

PROTECTION OF MINIMUM RETIREMENT AGE Mrs A Clwyd
 Y) Commons: (63) 1R: 21.1 Bill withdrawn: 19.2 (not printed)

PUBLIC ORDER Mr D Hurd/Lord Glenarthur (Government)
 A) Commons: (40,129,226) 1R: 5.12 2R: 13.1 Comm (SC G): 23.1-10.4 Rep & 3R: 30.4
 LA: 4.11
 Lords: (146,244,252) 1R: 1.5 2R: 13.6 Comm: 16 & 24.7, 6 & 21.10 Rep: 21 & 23.1
 1R: 20.10 Royal Assent (cap 36, 1986): 7.11

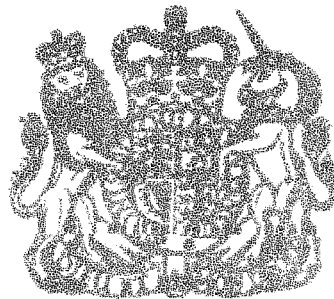

Outer Space Act 1986

1986 CHAPTER 38

An Act to confer licensing and other powers on the Secretary of State to secure compliance with the international obligations of the United Kingdom with respect to the launching and operation of space objects and the carrying on of other activities in outer space by persons connected with this country. [12th July 1986]

B E N ENACTED by the Queen's most Excellent Majesty, by and with the advice and consent of the Lords Spiritual and Temporal, and Commons, in this present Parliament assembled, and by the authority of the same, as follows:—

Application of Act

1.—This Act applies to the following activities whether carried on in the United Kingdom or elsewhere:—

- (a) launching or procuring the launch of a space object;
- (b) operating a space object;
- (c) any activity in outer space.

Activities in which this Act applies

2.—(1) This Act applies to United Kingdom nationals, to British firms, and bodies incorporated under the law of any part of the United Kingdom.

Persons to whom this Act applies

(2) For this purpose "United Kingdom national" means an individual who is—

- (a) a British citizen, a British Dependent Territories citizen, a British National (Overseas), or a British Overseas citizen,

security of the United Kingdom or loss suffered by third parties elsewhere, as a result of the licence; and the licence on a specified

with the written conditions in other cases as may be

to vary or suspend a licence or where it appears to

any regulation made under the Act applied with, or

suspension of the licence on public health or national security or international obligation

of a licence does not comply with the conditions of the

maintain a register of licences

register such particulars as the Secretary of State considers appropriate in connection with the obligations of the United Kingdom

to register on payment of a fee and to describe the licence.

8.—(1) If it appears to the Secretary of State that an activity is being carried on by a person to whom this Act applies—

- (a) in contravention of section 3 (licensing requirements), or
 - (b) in contravention of the conditions of a licence,
- he may give such directions to that person as appear to him necessary to secure compliance with the international obligations of the United Kingdom or with the conditions of the licence.

Power to give directions.

(2) He may, in particular, give such directions as appear to him necessary to secure the cessation of the activity or the disposal of any space object.

(3) Compliance with a direction may, without prejudice to other means of enforcement, be enforced on the application of the Secretary of State by injunction or, in Scotland, by interdict or by order under section 91 of the Court of Session Act 1868 (1968 c. 100).

9.—(1) If a justice of the peace is satisfied by information on oath that there are reasonable grounds for believing—

- (a) that an activity is being carried on by a person to whom this Act applies in contravention of section 3 (licensing requirements) or in contravention of the conditions of a licence, and
- (b) that a direction under section 8 has not been complied with, or a refusal to comply with such a direction is apprehended, or the case is one of urgency,

Warrant authorising direct action

he may issue a warrant authorising a named person acting on behalf of the Secretary of State to do anything necessary to secure compliance with the international obligations of the United Kingdom or with the conditions of the licence.

(2) The warrant shall specify the action so authorised.

(3) The warrant may authorise entry onto specified premises at any reasonable hour and on production, if so required, of the warrant.

(4) The powers conferred by the warrant include power to use reasonable force, if necessary, and may be exercised by the named person together with other persons.

(5) A warrant remains in force for a period of one month from the date of its issue.

(6) In Scotland the reference in subsection (1) to a justice of the peace shall be construed as a reference to a justice of the peace or a sheriff and the reference to information shall be construed as a reference to evidence.

Outer Space Act 1968

- (iv) preserve the national security of the United Kingdom;
- (v) requiring the licensee to insure himself against liability incurred in respect of damage or loss suffered by third parties, in the United Kingdom or elsewhere, as a result of the activities authorised by the licence;
- (vi) governing the disposal of the payload in outer space on the termination of operations under the licence and requiring the licensee to notify the Secretary of State as soon as practicable of its final disposal; and
- (vii) providing for the termination of the licence on a specified event.

Transfer, variation, suspension or termination of licence.

4.—(1) A licence may be transferred with the written consent of the Secretary of State, and in such other cases as may be prescribed.

(2) The Secretary of State may revoke, vary or suspend a licence with the consent of the licensee or where it appears to him—

- (a) that a condition of the licence or any regulation made under this Act has not been complied with, or
- (b) that revocation, variation or suspension of the licence is required in the interests of public health or national security, or to comply with any international obligation of the United Kingdom.

(3) The suspension, revocation or expiry of a licence does not affect the obligations of the licensee under the conditions of the licence.

Other controls

Register of space objects.

5.—(1) The Secretary of State shall maintain a register of space objects.

(2) There shall be entered in the register such particulars of such space objects as the Secretary of State considers appropriate to comply with the international obligations of the United Kingdom.



(3) Any person may inspect a copy of the register on payment of such fee as the Secretary of State may prescribe.

8.—(1) If it appears to the Secretary of State that any person is being carried on a space object—
(a) in contravention of this Act,
(b) in contravention of any regulation made under this Act,
he may give such directions as he considers necessary to secure compliance with the provisions of this Act or of any regulation made under this Act.

(2) He may, in the exercise of his powers under this section, require any person to furnish him with such information as he may require for the purpose of enabling him to exercise his powers under this section.

(3) Compliance with any such directions shall not constitute a defence to any offence committed by a person in contravention of this Act or of any regulation made under this Act.

9.—(1) If a person is found to be in possession of a space object or any part of a space object, he shall be liable to be detained until such time as he has been released or the object has been returned to the person from whom it was obtained.

(2) The Secretary of State may, in the exercise of his powers under this section, require any person to furnish him with such information as he may require for the purpose of enabling him to exercise his powers under this section.

(3) Compliance with any such directions shall not constitute a defence to any offence committed by a person in contravention of this Act or of any regulation made under this Act.

10.—(1) The Secretary of State may, in the exercise of his powers under this section, require any person to furnish him with such information as he may require for the purpose of enabling him to exercise his powers under this section.

(2) Compliance with any such directions shall not constitute a defence to any offence committed by a person in contravention of this Act or of any regulation made under this Act.

(3) Compliance with any such directions shall not constitute a defence to any offence committed by a person in contravention of this Act or of any regulation made under this Act.

(4) Compliance with any such directions shall not constitute a defence to any offence committed by a person in contravention of this Act or of any regulation made under this Act.

Section 40

Section 40

Lacon.

Section 40

File = / 12/3

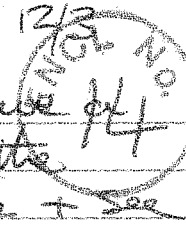

8.45pm 4th Jan

Please have a look in the UFO file + see if we have a report.

Dolgellau area (+ Bala)

Groesynant - Sighting

Cutting from local paper call to see whether we have any reports.

Ta

Section 40

Section 40

: his reports on file!

Section 40

17/1

Phoned 23/1 to give him the news.

Section 40



Section 40 Secretariat (Air Staff) 2a
MINISTRY OF DEFENCE Room Section 40

Main Building Whitehall London SW1A 2HB

Telephone (Direct Dialling) Section 40
 (Switchboard)



Section 40

Your reference

Our reference

D/Sec(AS)12/3

Date

19 January 1990

Dear Section 40

Thank you for your report to RAF Rudloe Manor of an unusual sighting you witnessed on 8 December 1989, which has been passed to the Ministry of Defence for reply.

You may find it helpful if I begin by explaining that while the Ministry of Defence does receive and co-ordinate some reports of UFO sightings, our sole concern is to determine whether or not they present a threat to the security of the United Kingdom. Unless we judge that they do, and this has not been the case so far, we do not attempt to investigate further, or to identify whatever might have been seen.

Given this limited involvement with the subject, the Ministry of Defence does not have any department which is appointed solely for the purpose of studying UFO reports, nor do we have any staff employed on the subject full time. As you will expect, therefore, we do not carry out studies, investigations or surveys into the phenomena. I am sure you will appreciate that defence funds are already fully committed to maintaining the security of the UK against, primarily, aggression from the Warsaw Pact countries. This being so, we could not justify the use of funds on scientific investigations unless a clear threat to security had been identified.

In this context, I regret that I am unable to offer a definitive explanation for what you witnessed. I hope you will understand that as no threat has been identified, the Ministry of Defence will not be investigating further. Nevertheless, we are grateful to you for taking the time to make a report.

Finally, I would like to confirm that we did not receive any reports similar to yours.

I hope that you will find this helpful.

Yours sincerely,

Section 40



Section 40 Secretariat(Air Staff)2a
MINISTRY OF DEFENCE Room Section 40

Main Building Whitehall London SW1A 2HB

Telephone (Direct Dialling) Section 40
(Switchboard)



Your reference

Section 40

Our reference

D/Sec(AS)12/3

Date

19 January 1990

Dear

Section 40

Thank you for your report of an unusual sighting you witnessed on 28 December, which has been passed to the Ministry of Defence for reply.

You may find it helpful if I begin by explaining that while the Ministry of Defence does receive and co-ordinate some reports of UFO sightings, our sole concern is to determine whether or not they present a threat to the security of the United Kingdom. Unless we judge that they do, and this has not been the case so far, we do not attempt to investigate further or to identify whatever might have been seen.

Given this limited involvement with the subject, the MOD does not have any department which is appointed solely for the purpose of studying UFO reports, nor do we have any staff employed on the subject full time. As you will expect, therefore, we do not carry out studies, investigations or surveys into the phenomenon. I am sure you will appreciate that defence funds are already fully committed to maintaining the security of the UK against, primarily, aggression from the Warsaw Pact countries. This being so, we could not justify the use of funds on scientific investigations unless a clear threat to defences had been identified.

In this context, I regret that I am unable to offer a definitive explanation for what you witnessed. I hope you will accept that we will not be investigating the matter. Nevertheless, we are grateful to you for taking the time to make a report.

I hope that you will find this helpful.

Yours sincerely

Section 40



MINISTRY OF DEFENCE

Main Building Whitehall London SW1A 2HB

Telephone: (Direct Dialling) **Section 40**
(Switchboard)



Your reference

Section 40

Our reference

D/Sec(AS)12/3

Date

17 January 1990

Dear

Section 40

Thank you for your recent letters of 15 December 1989 and 5 January 1990.

Your letter of 15 December asked for any information that we might have regarding a sighting in the Yorkshire/Lancashire area on 17 August 1972. As you will be aware from your correspondence with my predecessor **Section 40** the MoD has no department which is appointed solely for the purpose of studying reports of UFOs and we have no staff who are employed on the subject full time. Given this and the fact that the report to which you refer was dated over seventeen years ago, I am afraid that we do not have the resources to conduct the searches necessary to trace a report after such a passage of time and I cannot therefore provide you with a copy of any report of the incident you describe. We will, of course, consider any specific queries you may have about particular incidents which have occurred recently (i.e. within the last three years) and can let you know whether we have a report on the incident, and if so what it contains.

You also asked who in the MoD carries out investigations into UFOs. Since our interest in UFOs is limited to possible defence implications we do not carry out full-time studies into the UFO phenomenon nor indeed do we have the resources to undertake any in-depth investigations. I am sure that you will appreciate that defence funds are fully committed to ensuring the continuing security of the UK. This being so we could not justify the use of defence funds on scientific investigations, unless a clear threat to the security of the UK had been identified.

Your letter of 15 December refers to complaints by members of the public who have claimed to have been visited by alleged MoD investigators. On this matter I can only reiterate the advice offered by **Section 40** in his letter to you of 20 October 1989 that it is not the MoD's policy to interview people in connection with UFO sightings.

Turning to your letter of 5 January, with regard to your questions about MoD scientific research in respect of UFOs, I am

afraid I can only re-assert that we do not carry out full-time studies into the UFO phenomenon. Since the MoD does not undertake projects related to the UFO phenomenon I cannot, of course, provide you with a list of classifications of non-existent UFO-related projects. Referring again to Mr Section 40 letter to you of 20 October I would like to repeat that all the information we have on UFOs is unclassified.

Finally, I would like to assure you that there is no question of attempting to cover up any incident, nor are we trying in any way to obscure the truth about UFOs from the general public.

Yours sincerely,

Section 40

From: Section 40 Secretariat (Air Staff)2a, Room Section 40



MINISTRY OF DEFENCE

Main Building Whitehall London SW1A 2HB

Telephone: (Direct Dialling **Section 40**)
(Switchboard)

ENGL
10

Section 40

Your reference

Our reference D/Sec(AS)12/3

Date 17 January 1990

Dear

Section 40

Thank you for your recent letters of 15 December 1989 and 5 January 1990.

Your letter of 15 December asked for any information that we might have regarding a sighting in the Yorkshire/Lancashire area on 17 August 1972. A check through our locally-held files has proved fruitless and I can only conclude, (given the incident you describe was dated over seventeen years ago), that any report made to the MoD would have since been sent to our records depository outside central London. As you will be aware from your correspondence with my predecessor **Section 40** the MoD has no department which is appointed solely for the purpose of studying reports of UFOs and we have no staff who are employed on the subject full time. Consequently, I am afraid that, as we do not have the resources to conduct further searches except at disproportionate effort and expense, I cannot provide you with a copy of any report of the incident you describe. We will, of course, consider any specific queries you may have about particular incidents which have occurred recently (i.e. within the last three years) and can let you know whether we have a report on the incident, and if so what it contains.

delete

trace

You also asked who in the MoD carries out investigations into UFOs. Since our interest in UFOs is limited to possible defence implications we do not carry out full-time studies into the UFO phenomenon nor indeed do we have the resources to undertake any in-depth investigations. I am sure that you will appreciate that defence funds are fully committed to ensuring the continuing security of the UK. This being so we could not justify the use of defence funds on scientific investigations, unless a clear threat to the security of the UK had been identified.

Your letter of 15 December refers to complaints by members of the public who have claimed to have been visited by alleged MoD investigators. On this matter I can only reiterate the advice offered by **Section 40** in his letter to you of 20 October 1989 that it is not the MoD's policy to interview people in connection with UFO sightings.

Turning to your letter of 5 January, with regard to your questions about MoD scientific research in respect of UFOs, I am afraid I can only re-assert that we do not carry out full-time studies into the UFO phenomenon. Since the MoD does not undertake projects related to the UFO phenomenon I cannot, of course, provide you with a list of classifications of non-existent UFO-related projects. Referring again to Mr **Section 40** letter to you of 20 October I would like to repeat that all the information we have on UFOs is unclassified.

Finally, I would like to assure you that there is no question of attempting to cover up any incident, nor are we trying in any way to obscure the truth about UFOs from the general public.

Yours sincerely,

Section 40

From: **Section 40** Secretariat (Air Staff)2a, Room **Section 40**



LOOSE MINUTE

D/Sec(AS)12/3

17 January 1990

DI55
DD Sy(RAF)

Copy to:

DD MOD Sy
DDGE/AEW

Section 40 [redacted] - UFO CORRESPONDENT

Reference: D/Sec(AS)12/3 dated 2 October 1989
(Copy attached - Annex B)

1. I attach at Annex A a copy of a recent letter and another document which Sec(AS) has received from **Section 40** [redacted] who is a persistent correspondent and caller regarding UFOs.
2. My predecessor, **Section 40** [redacted] was concerned that **Section 40** [redacted] activities in his pursuit of information regarding the UFO topic were taking an unusual turn, including the recording of their telephone conversations (see Reference). Now we have received from him what purports to be an official MoD document dating from 1978. I do not intend to answer this particular letter, but would appreciate advice regarding the authenticity of the document as it is not recognised by ourselves.
3. **Section 40** [redacted] correspondence with Sec(AS) regarding UFOs has been going on for only five months, but in that time we have had a number of phone calls and letters which we have answered in the usual way, seemingly with no diminution in **Section 40** [redacted] belief that we have more information to impart. We have two other letters outstanding for which a reply restating our normal line will be sent out shortly.
4. I now believe that **Section 40** [redacted] is becoming a nuisance and consideration is being given to blacklist him. Therefore any advice regarding **Section 40** [redacted] activities and background would be gratefully appreciated.

Section 40 [redacted]

Sec(AS)2a

Section 40 [redacted]

ENCLOSURE
8/2

MINISTRY OF DEFENCE
Sec. (AS)2
23 JAN 1990
FILE

Section 40

Room Section 40
Secretariat (Air Staff)2a,
Ministry of Defence,
Main Building Whitehall,
London, SW1A 2HB

Section 40

Date: Jan. 19th, 1990
Ref: 90-0119/3

Dear Section 40

This is in response to your letter, dated 17 JAN 1990, Ref. D/Sec(AS)12/3.

If there is no COVER UP then why does not MOD answer to streight forward questions put to you pertaining to UFOs?

In all the previous replies in hand from MOD, to various inquirers, which I have in my files, MOD DOES state categorically that, if there is a specific UFO incident reported to MOD, then MOD would gladly comply with the request. There is NEVER a question of TIME ever mentioned in your answers so that the inquirers realise how to make their inquiries with regards to specific incident. If this is not a contempt from your side, then what is a contempt? In our letter dated 15 DEC 1989, we addressed MOD with regards to records pertaining a well documented case. In doing so we did COMPLY with the instructions several times MENTIONED in MOD replies to the PUBLIC. We were SURE that your office as usual would come out with an excuse. We did file this request for the sake of records. We believe MOD does treat public's inquiries on this subject with contempt, and there is a delibrate COVER UP, your answer to my letter emphasizes this.

You have mentioned that MOD NEVER makes discret inquiries into the UFO incidents. This simply is NOT TRUE. The case for which we requested your records for, is a classic one, where MOD personel in front of eyes of several members of the public including journalists, actually did intervene, questioned the witnesses and ordered the journalists to leave. In fact, in that particular case a POLICE officer was present which was actually helping the witnesses in catering the journalists by making them some hot drinks. We do have a dozen of signed statements to prove this fact. Are you suggesting that all these members of the public including the POLICE are lying? I demand a streight answer from MOD on this. The other case, which I brought to your attention is the case of the newspaper editor, who was ADVISED by MOD officers to keep quiet and not to publish about the case in question which was equally important. Is he LIEING? I demand an answer. ?

I had asked you the role of the Naval Intelligence in investigation of UFOs. You totally disregarded my question. We are told that in almost every major UFO incidents in any of the RAF bases, there is a Rear Admiral present. Could you comment on that. I demand a specific answer.

I repeat my questions in my letter dated 5 JAN 1990 again, which you had totally disregarded. I need itemized answers to my questions.

You have mentioned MOD does not have full time personnel to study the UFO cases. Point taken. Then, THOSE WHO ASSESS THE CASES, as a part of their duties., which department/s of MOD they work for?

I repeat my question put to MOD previously; On what grounds MOD reckons that UFOs do not constitute a threat to the country. As a physicist I would like to know the results of their scientific findings, upon which you constitute your CIRCULAR LETTER REPLIES. As I said in my previous letter, I do not believe you have the scientific knowledge to analyse any case. You, as a coordinator would only pass the reports to the relevant departments for final or preliminary assessments. What are does departments?

You have mentioned it is not MOD's POLICY to interview people in connection with UFO sightings. First, I would like to receive, if I may, a printed copy of MOD's policy to which you have referred to if there is one, to confirm your statement. Bearing in mind that it is you who is making reference to a POLICY. Secondly, the other interpretation of your words enhances a different meaning. People are visited, not in connection of UFOs, but, to make sure, that what they have seen is no longer UFO but an IFO. Hence, what to the general public might be a UFO, for MOD no longer is one. MOD already knows what they are, and all these times public have been asking the wrong questions, but MOD has been giving them the correct answers, because MOD DOES KNOW what they are. If this is the case, and if as you call them the "so-called UFOs", do not constitute a threat to the National Security, then it is all too apparent that you know what they are, and they no longer are UFOs, yet keeping the public in the dark. If you have the answer for a subject which is UNCLASSIFIED, why not letting the public know about your findings? What are they? Are some of them IDENTIFIED, ALIEN PILOTED CRAFTS?

Finally, could you please provide us with a statistical number of reported sightings to MOD for the year 1988 and 1989, or this also is impossible?

I would like to receive a proper, itemized answers to my question to you in my letter dated Jan. 5th, 1990.

Yours truly,

Section 40

PS: What is the function of MOD's Special Petrol Group in relation to UFOs?

Files 2/3

- Pse upgrade file

UNCLASSIFIED

CONFIDENTIAL



IMMEDIATE

Section 40

LOOSE MINUTE

DI55/108/15

11 January 1990

D/Sec (AS) Sy4(RAF)

Copy to :

DD GE/AEW

ms 17/1

Agreed -

Pse confirm with Jim O'H that he is happy for us to suggest helo movements.

Section 40

In view of this suggest standard letter with bit saying we have ascertained helo activity in your area and what you saw was prob assoc with helo movements.

Section 40

Section 40

REPORT OF AN UNIDENTIFIED FLYING OBJECT - NORTHERN IRELAND

- Reference : A. ATC Belfast (Aldergrove) Airport dated 21 Dec 89
- B. MOD(UK) 040857ZJAN90
- C. NORIRELAND 051026ZJAN90
- D. RAF ALDERGROVE 051705ZJAN90

1. The report at reference (A) of an unidentified flying object 1.5 miles southeast of Glenavy Northern Ireland warranted investigation, primarily regarding the security implications, secondly to try to ascertain the cause of the aerial phenonema.
2. We have been advised that there were no reports of any terrorist incidents during the period in question.
3. RAF Aldergrove has informed us that there were no fixed wing aircraft in area at the date and time stated.
4. Two rotary wing movements occurred within 5 minutes either side of the reported sighting. Firstly a Gazelle departed Aldergrove at 1640Z en route to the southeast. Secondly a Wessex en route from Lisburn landed at Aldergrove at 1655Z.
5. Taking into account para's 2,3 and 4, plus no other UFO activity being reported throughout the UK and Northern Ireland, I suggest probably witnessed the arrival or departure of the helo's at Aldergrove.

Section 40

DI55c1

Section 40

MINI. OF DEFENCE
 Hd. Sec (AS).
 17 JAN 1990 205
 FILE

UNCLASSIFIED

CONFIDENTIAL

Section 40

Section 40

pl. deal

Section 40

we need to ask a few questions
Is the list a genuine
MOD document?
If so how did Dr-H get hold of it? and
where did it come from.
This is getting beyond a joke!
16/1

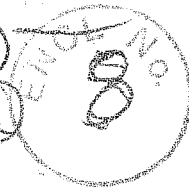

Section 40

Section 40

Defence Secretariat 8
Ministry of Defence,
Main Building,
Whitehall,
London, SW1A 2HB

9/18

Date: Jan. 11th, 1990
Ref: 90-0111/6

Dear Sir,

As a research physicist I have been studying the UFO phenomena for several years. I am enclosing a copy of your released material with regards to the UFOs.

Could you please provide me with a copy of similar report of the years 1988, 1989, which would enable me to further my research project pertaining a global number of sightings.

Whilst thanking you in advance for your consideration, I look forward to hearing from you.

Yours sincerely,

Section 40

cc: Earl of Kimberly
Lord Rees-Mogg
File.

Note: The attached form appeared in a copy of 'UFO News' in A79. The MOD response was nothing to do with us

Section 40

20/3

UFO/45/1MEMO/666/78

MINISTRY OF DEFENCE DEPARTMENT OF AERIAL STUDIES

*** CLASSIFIED TO ALL PERSONNEL BELOW AGDO 2

CONTACTS FOR THE YEAR ENDED 22/ 2/78. (23) AS FOLLOWS:

K5634	J. MITCHELL	LEICESTER	559/7C	CLASS 5	23/ 5/77 0935
K5635	O. KRAMER	BRADFORD	11A/7	CLASS 5	24/ 5/77 1116
K5636	D.M. SMITH	LONDON (SW)	559/7C	CLASS 3	15/ 6/77 0600
K5637	F.W. SHOEMAKER				
K5638	R.L. DOORS	LONDON (SW)	559/7C	CLASS 5	23/ 7/77 1755
K5639	T. BETTS	FALMOUTH	558/0'X	CLASS 2D	23/ 7/77 1721
K5640	W.M. GRANGER	LLANELLI	555/C45	CLASS 5	1/ 8/77 0931
K5641	T.D. PATEL	SOUTHALL	6400KW/2	CLASS 1E	11/ 8/77 1159
K5642	S.L.D. O'BRIEN	LEEDS	559/7C	CLASS 5	16/10/77 0445
K5643	T. MONANARA	BELFAST	088/23	CLASS 1E	22/11/77 2350
K5644	B.F. WEST	ABERDEEN	088/23	CLASS 6	23/11/77 0020
K5645	T. BRANDENBURGER	SLEIGH	559/7C	CLASS 5	14/12/77 1807
K5646	F.K. SKINNER	BELFAP	H6/44/46	CLASS 1E	23/12/77 2300
K5647	W.W. WRIGHT	DUREY	559/KW	CLASS 5	31/12/77 1305
K5648	T.M. SLABY	TRURO	559/7	CLASS 8	2/ 1/78 0430
K5649	D.W. MARCUS	LEIST	1080/46	CLASS 1C	23/ 1/78 1031
K5650	A. ANDREWS	GLASGOW	559SERIES	CLASS 5	1/ 2/78 0945
K5651	D.T. SMEDLEY	LONDON (E)	7A/70	CLASS 23	22/ 2/78 1201

/ENDLIST

CLASSIFICATION NOTIFIED TO THE FOLLOWING DEPARTMENTS:

METROPOLITAN POLICE

DEFENCE (AIR FORCE)

DEFENCE (CIVIL)

SPECIAL PATROL GROUPS

B.B.C. (INTELLIGENCE BRANCH)

SUB-REGIONAL CONTROLS

COMPUTER DATA SECTION

MICROWAVE COMMUNICATIONS NETWORK

/ENDLIST

FURTHER CONTROLS AND DATELINE NETWORK CMDAR VIA NDHQ CHELTENHAM

OPERATION 25 NOTIFICATION TO SECTIONS B H W Z VIA NDHQ CHELTENHAM

NORAD CYBERTECH LINK F 6

DATA COMPILATION NETWORK SECTIONS H K W

FURTHER NOTIFICATION FOR ACTION TO BE TAKEN VIA COMM. 46 (78)

RLD CIA NORAD UFO 23

*** LISTED AND CLASSIFIED

/END COPY 17/ 75 CLASSIFIED 2298/44/C/AGDO 2/23H

Section 40

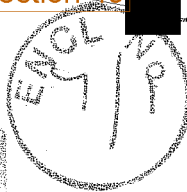

we had a call last week from D155 saying they were looking at this - wait until we hear from them?

Section 40

8/1

Yes please.

MINISTRY OF DEFENCE
Sec. (AS)2
- 8 JAN 1990
FILE

LOOSE MINUTE

D/CG&DGSY (RAF) /80/7/7

4 Jan 90

Sec (AS) 2a

Copy to:

DI 55
DD GE/AEW

REPORT OF UNIDENTIFIED FLYING OBJECT - NORTHERN IRELAND

Reference:

A. D/Sec (AS) 12/3 dated 29 Dec 89

1. Thank you for your LM, Reference A, together with the accompanying UFO report from Belfast Air Traffic Control. You should recommend that the CAA at Belfast Airport send a holding reply to Section 40 and then report the details to the Royal Ulster Constabulary (RUC) for investigation. If a muffled bang was heard there may be recoverable evidence. Not being familiar with the area in which the UFO was sighted I cannot comment on there being some form of rational explanation for the sighting. Alternatively I do not think we should be jumping to any conclusions or drawing any assumptions from the sighting until the RUC have carried out an investigation.

2. HQ NI may be able to help in solving Section 40 report which may relate to the discharge of a weapon.

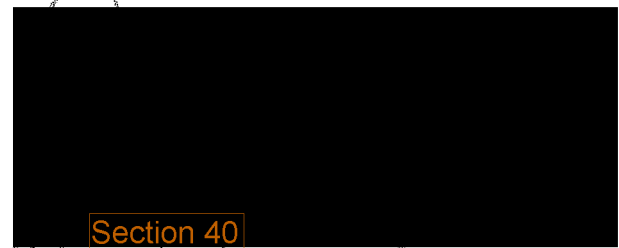

Section 40

Wg Cdr
Sy 4 (RAF)

Section 40

RAT, RUDLOE.

from

Section 40

RE a U.F.O.

SIGHTING

FLYING

JAN 1959 U.K.

31-12-89.

I am indebted to a retired (now) officer in the Royal Observer Corps for rec. that I wrote to you concerning an apparant "Sighting" in December.

Section 40 I can verify that I am not given to fanciful notions, having known him since I was 16, and later I was a member of the Observer Corps at the latter end of the war. Consequently I know what a conventional aircraft should look like, and have some notion of estimated heights. I find that weather conditions can enhance or detract from the size of things in flight, making them seem larger or nearer, or further and smaller than they really are - I do Bird watching; rather to note their behaviour than to collect lists of bird-sightings.

I live on the outskirts of a Cotswold village, near the escarpment edge, overlooking the Severn Vale - the village, not me!

There are flying establishments in the area, such as Staverton, Fairford, further away, Brize-Norton, Filton, Kemble. If I can locate a small map of the area, I will enclose same.

My 'sighting' was of a most unremarkable object! In fact, I liken it to a flying pudding!

Section 40 Thanks it may tie-up with some other information you already have on record, so to advise your relevant dept.

Section 40

DATE. December 8th 1989.

TIME. 11.45.

PLACE. OUTSKIRTS OF BIRDLIP VILLAGE. GLOS'SHIRE.

WEATHER. OVERCAST. NOT WITH AN ACTUAL CLOUD BASE BUT GENERALLY 'DULL' AND GREY. NO SUNLIGHT.

WIND. LIGHT. EASTERLY, BUT CAN BE DEFLECTED BY CONTOURS OF LANDSCAPE.

I didn't carry my camera, that day as the light was not good for my rather cheap model.

I had no one else with me at the time. (just me dog) Actually dogs are very alert to experiences and atmospheres that humans cannot "register." Mine was not effected by the progress of U.F.O. almost immediately over our heads.

SIGHTING TIME. AT LEAST 3 MINUTES.

HEIGHT. ABOUT 500 ft. above me, which would be approx 1000 ft above sea level.

FLIGHT PATH.

East to West. [Looking at map, it should be N.E. to S.W. ?]

PROGRESS.

Slow, when compared with traditional aircraft of any kind.

MY POSITION.

Standing in the shallow scoop of land below Hawcote ridge, in a field of grass keep, without obstruction of trees, bushes, buildings etc.

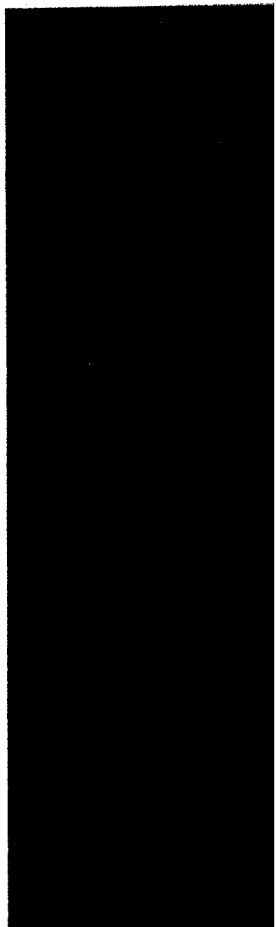
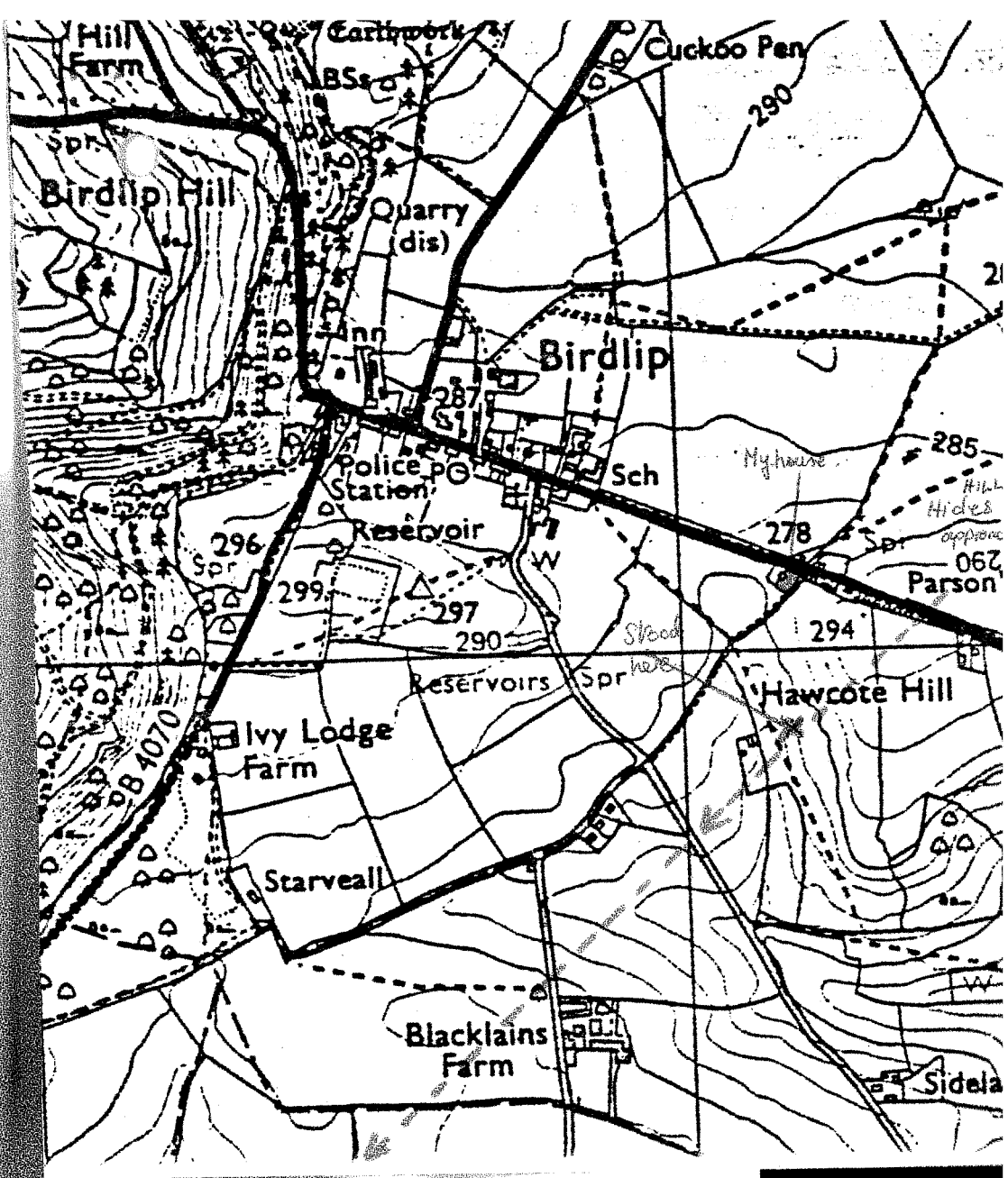

Description of Event.

Because I 'look out' for Birds, standing waiting for my dog to catch up with me, I chanced to look up towards Hawsote Ridge - thus towards the East - and noticed "Something largish" coming towards me from over the ridge; thinking that at a distance it could be a Buzzard or Heron (seen hereabouts) I waited and watched it's approach. [A Heron would have trailing legs; a Buzzard would, more likely than not, ^{be} gliding] I'm trying to recall another reason why I presumed it to be a bird and I think it's shape when first seen at some distance must have given me that impression because it seemed to be the shape of a bird in flight until I realized that it hadn't got wing-beats. So it's shape must have been somewhat "flat" rather than "lumpy" as it proved to be as it came nearer. I've looked up the word "TRAJECTORY" - "Path of a body moving under given forces" and that describes it, exactly.

It didn't deviate, undulate, wobble, swing from side to side, flap, flutter or float (as a balloon of some kind) It came on, quite steadily, moving as if it was a bead drawn along a string or taut wire, so eventually I was looking up to it from below starboard.

There were no wings. No tail plane. No actual pointed "nose".

It was of no particular colour that I could tell [as I said the atmosphere was not clear; misty enough to perhaps blur a clear outline and conceal markings and colourations.] Not white or even light in colour!

IF there was any sound coming from this object it was masked by the light wind conducting traffic

noise from the By-Pass road. It would need to have been a robust sound if I was to hear something emitting from the object.

No sparks or 'showy' effects.

Just a solid 'something', disinterested in what was around it, progressing steadily across my immediate horizon, until it disappeared into the far distance, passing beyond Blacklains Farm.

As compared with what I have heard concerning other peoples U.F.O's, mine must be very disappointing. However, I did see this unusual object, and watched it, and it wasn't an hallucination! I listened to local news, and looked in local papers in case someone else had seen anything and had reported it, but have not struck lucky, so far.

If this report does tie-up with something you already know about, will you be kind enough to tell me? **Section 40** will also be interested to know the outcome. Thankyou. **Section 40**

I cannot estimate speeds, but I can compare movements with other things. Slow when compared with modern aircraft (I'm used to low level flying fighters - unfortunately - here) like, "going down hill, fast, on-a-bicycle", sort of speed, but level flight, of course.

The contours appeared to be smooth, not rough. It did seem to be on a pre-determined course. Although a 'lump', it did shape off flatter when first observed, and last noted.

No. I didn't have the binoculars with me, either!



Tel: Wx 35943

Squadron Leader
R. A. F. Station
North Weald
Essex.

Dear Sirs,

Re. U.F.O. Sighting 28th Dec.

I wish to report this phenomena which occurred early hours of 28th Dec approx. 1.00 am. I was retiring to bed & had switched off the lights & I glanced out of the window. The garden seemed to be bathed in a strange light. On looking out, there appeared in the sky, a large, orangy-red ball, roughly the size of a football. It seemed to roll along quite slowly (it did not wizz) & there was smoke trailing from behind it. There might have been some kind of noise, but it didn't register. The sighting lasted perhaps a minute, whereupon the 'ball' seemed to peter out

P.T.O.

Please send this letter to the appropriate dept. or some kind of organization that deals with matters like this.

Please note that this is not a hoax,
I had not been drinking at all that night!
Also, I am not a 'crank' + am certain
I was not dreaming.

Yours faithfully,

Section 40

Section 40

CL No
50

27/12/89.

Dear Sir.

I am making enquiries pertaining to a certain dubious UFO report. The incident has come from one of our regional groups who have giving me the report.

Date 5th July

Time 11.10pm

Objects seen. 1 UFO. 1 F3 Tornado in chase...plus FIRED at it?

Height of both 400ft / 450ft.

Speed 600 knots.

Size put to object twice the size of the jet.

TRAJECTORY. came out of the East from the sea flew past the Blackpool Tower and headed inland towards the Pennines.

Weather. clear with light high clouds.

Sighted. Junction of Grasmere rd 1 mile from the Tower.

I have spoken to the witness on a number of occasions and find that there may be some call to investigate the witness further. I know that several reports have hailed from this Section 40. You may or you may not know that the said incident has reached the British media. This sighting I have been informed has also reached Europe. that is totally unacceptable my feelings are that this as all the other reports this man put forward is a HOAX. I have made certain enquiries with R A F bases that may fly over our quadrant and find that no such jet took to the air. there is nothing reported by . Air ports. Blackpool. Liverpool & the Coastgaurds. or the Civil Aviation Authority.

If you have any information which could explain this event I would be glad to hear of it. Also I have been infomed that Section 40 made a report shortly after the said event. on talking to a P O Section 40 no report was made that night at South Shore Police station.

I await your answer in which I hope to wrap this case up and put it to rest on the reply of your letter.

Yours sincerely

Section 40

WITH COMPLIMENTS

WO Section 40

Aeronautical Information Section (Military)

London Air Traffic Control Centre

Royal Air Force West Drayton

Porters Way

West Drayton

Middx UB7 9AU



Tel. Section 40

11 January 1989.

Dear sir,

I would appreciate if the following data could be given out, On the 10th June 1989. several objects were seen flying high over Blackpool. West to East. times are as follows.

15.22....3 ufo

15.38...5 ufo

15.43...2 ufo

16.00...1 ufo

16.15...1 ufo

16.25...1 ufo

17.03...1 ufo

18.00...2..ufo

Average distance to be estimated at 30 to 35.000 ft up. nearest land mark that they flew over was Blackpool Tower.

5th July 1989. 1 UFO reported as being chased by a F3 Tornado. flight path past the Blackpool Tower. height around 400ft up. speed of F3 to be suggested at 600 knots. time 11.10pm. direction West to North.

If there was any training exercise that was in progress that may explain the 2 reports that are listed above I would be truly grateful that I could be giving some kind of details.

yours sincerely

Section 40

19.12.89



Section 40

Secretariat(Air Staff)2a,
Ministry Of Defence,
Main Building Whitehall,
London SW1A 2HB

Section 40

Dec. 15th, 1989
Ref: 89-1215/3

Dear Section 40

Further to our recent telephone conversation, and with reference to several previous letters from MOD to me and some of my colleagues, in which your predecessors frequently have emphasized that previous specific UFO cases which have been reported to MOD would be available to the inquirers, I would like to make the following request as a test case with regards to the validity of what we have been told.

The below mentioned case is indeed well documented, by both the Police and MOD personel.

The incident took place on August 17th, 1972, 2 am, on the bypass road between the city of York to Manchester. Section 40 were driving back from York, they were in one but last of a convoy of four cars. Somewhere along their journey they noticed police cars parked on the side of the road. This attracted their attention. Stop the car and noticed a Melon Shape Object, which was landed on the field on the side of the road. Glowing green. Police also was quite curious about the object. In brief, when they returned home that night, the local police called in and asked them to explain to them what they had seen.

Following morning the story somehow had reached the press, whilst the journalists were in their home trying to get more information from Taylors, two civilians arrived, showed MOD cards and ordered the press to live and spent 50 plus minutes with the Section 40. My understanding is that the MOD personel would have been from the Air-Space Intelligence section of MOD gathering information. As such, I hope I would be able to request to have a copy of MOD report on this old case.

I would also be grateful if you could answer the following questions in order to cast more light on MOD's activity relating to UFOs.

Reports from the military establishment reaching to MOD, according to their significance require investigations. There are several such reports which I am sure is in your possession from this year and the years before. Which section of the MOD carries out the investigations. Is it the Naval Intelligence?

Several time we are told that only your department is in charge of receiving UFO reports. Do you still confirm this, although some evidence in hand indicates otherwise?

MOD continuously maintains that the UFOs do not constitute any serious

threat to the national security of this country. Could you please let me have the final report of the MOD's findings which has led to this conclusion. Or is this only a white wash to divert public's attention from this subject. One would think, MOD would make every endeavour to gain the public's confidence on this subject and in doing so, I hope I would be able to receive a copy of such final analysis of the MOD's finding. Obviously, such report would have been compiled by certain scientists of high stance and calibre.

I do not think, nor did **Section 40** that MOD would have reached to such conclusion without proper examination of the phenomena.

Finally, I would like to know what other departments of MOD have involvement with the UFO phenomena. I do not think that your office as a coordinator would have the final responsibility. It may well be that your office has the final responsibility in convincing the general public, but I do not think that you as a person, or a civil servant have either the scientific knowledge or the final responsibility either in analysing the reports from the military or some serious civilian UFO related incidents. You may have the authority as the spokesman addressing the public in their inquiries, which at times admittedly are of trivial significance.

I have several reports of complaints by the public who have witnessed serious UFO incidents, and subsequently had a visit from the alleged MOD investigators. Most of the times when they have been asked to produce ID cards, they have shown the witness/s their MOD cards, giving various departments' names, yet despite having the names of these MOD investigators, and addressing MOD for some kind of logical respond, always MOD has categorically denied any involvement in these cases. This arises a serious question. Are you suggesting that all these people are liars? Are you suggesting that these decent, ordinary people are all stating, and creating fictional tale tells? Or, there is some serious cover-up on this subject that for obvious reasons you do not want the public to know? Could you let me know what is on the other side of this coin.

Very recently, one of our close friends had a visit by two alleged MOD investigators, showing him their ID card, and asking him questions. The same person, who was quite terrified by this experience has sworn that he has been followed by a car for quite sometimes. I can not believe that an ordinary UFO organization in this country would have the time or the resources to follow an ordinary person for weeks, and finally deploying such tactics in order to obtain information. Could you comment.

In other occasion the editor of a newspaper who was reporting on a current incident was silenced by MOD personel. When I addressed your predecessor on this by sending him a copy of the paper, where the editor had refused to accept such violation of freedom of press, your fellow colleague denied MOD's involvement. Was the editor lying?

If there are such dubious organization, who quite freely move around and produce such convincing types of IDs to the public, and show such deep

knowledge about various MOD departments, why MOD does not take any positive action or show any encouraging initiative to locate and punish the culprits to satisfy the public? We are fully aware of the capability of MOD and I am sure such action would restore a great deal of public's trust.

I hope, I would receive more in depth reply to my inquiry than the altered version of the circular we always receive.

Yours Truly,

Section 40



cc: Earl of Kimberly
Lord Rees Mogg
files



*Spk to Rudloe
to try contacts
original*

*With the Compliments
of
Officer Commanding*

*Spk to Rudloe;
no sign of earlier
letter.*

HEADQUARTERS PROVOST AND SECURITY SERVICES
(United Kingdom)
FLYING COMPLAINTS & CUSTOMS LIAISON FLIGHT

Royal Air Force
Rudloe Manor
Hawthorn
Wiltshire
SN13 0PQ

Telephone Hawthorn **Section 40**

or Sir,

I have been checking over my correspondence do lately and have realised that the letter I sent to with regards to a F3 pairing a UFO has not been at to. I do realise that time to reply to letters may take time but it has been nearly 6 weeks.

With regards to the above matter the details are follows, 5th July 89 11-10pm Sighting near Blackpool tower

There has been some talk that the event actually may be fuel dumped into the sky as it flew past, the tower from an inland sighting by another witness, then that being the case I would very much like to have that confirmed so that I may be able to close the files and report it as a UFO.

Your response will be most welcome



Section 40

Secretariat (Air Staff)2a,
Ministry Of Defence,
Main Building Whitehall,
London, SW1A 2HB

Section 40

Date: Dec. 5th, 1990
Ref: 90-0105/2

Dear Section 40

Further to my letter dated 15.12.1989, for which I am waiting for your reply, I would like to attract your attention to my inquiries listed below. I have to emphasize that my inquiry is direct relation with my course of study and research of the UFOs.

1. Could MOD give me an assurance that there has never been in the past, or at the present, a project to develop a flying disc, its technology which is, or has been a derivative from any captured flying disc, either from extraterrestrial origin or developed by a nation on earth.

2. Could MOD confirm or deny the test flight of such disc, mentioned above, in the past or at present, either in this country or any other country of Common Wealth, or members of NATO.

3. Could you please provide me with a list of classification of documents or projects by MOD. These types of lists are available by a number of countries currently. Since we are a democratic country, one would have thought there should not be any problems with such request. I am not interested with the names of the projects, but the classification grading.

4. The JASON scientists in US are the scientists employed by the US government. Their names are known, so are the roles. We do have similar arrangement as I understand in UK. Could you please provide me with a list of their names. Since they are working for the betterness and advancement of our defence forces, obviously they would be the elite and proud of their work, which makes us as the citizens of the UK feeling equally proud.

5. Has MOD either in the past or at the present used the expertise of an English born scientist named Section 40 in any of their projects, or consulted him or his team about a project.

6. Has there been in the past, or is there at the present time any cooperation between the UK and any other country/s with regards to the subject of UFOs. The documents released through the FOIA or FOI do show or prove the interest, from our side.

Whilst thanking you in advance for your considered reply, I remain.

Yours Truly,

Section 40



cc: file.