

*The U.S. Textile and Apparel Industry: A  
Revolution in Progress*

April 1987

NTIS order #PB87-196762



**The U.S. Textile and  
Apparel Industry  
A Revolution in Progress**

**Special Report**



Recommended Citation:

U.S. Congress, Office of Technology Assessment, *The U.S. Textile and Apparel Industry: A Revolution in Progress—Special Report*, OTA-TET-332 (Washington, DC: U.S. Government Printing Office, April 1987).

Library of Congress Catalog Card Number 87-619815

For sale by the Superintendent of Documents  
U.S. Government Printing Office, Washington, DC 20402-9325  
(order form on p. 119)

# Foreword

America's textile and apparel industries are investing in new technology at an unprecedented rate. Productivity growth in textile manufacturing has been double the average growth of manufacturing as a whole for over a decade, and apparel production may be on the brink of a revolutionary increase. New information technologies have the potential to unify disparate elements of the industry, from fiber production and weaving to product assembly and retailing—linkages that can reduce costs and tailor products to changing patterns of consumer taste and preference. Such new technologies are rapidly changing the face of one of the Nation's oldest industries. The manufacture of textiles and apparel has the potential to remain a significant part of the U.S. economy.

Despite the optimism made possible by technical progress, U.S. textile and apparel firms are in danger. Little of the technology that allowed for increased productivity was developed by U.S.-based enterprises. The same advanced technology is available to firms throughout the world, including those in nations that pay workers a small fraction of the U.S. minimum wage. Sophisticated networks of U.S. and foreign companies use these factors to undercut U.S. supplier prices; apparel imports have grown from 25 to 50 percent of the U.S. market during the past 10 years. Technology alone may not be able to salvage major parts of the industry.

Increases in U.S. labor productivity and U.S. imports have led to significant job losses within the domestic textile and apparel industry. And while economic growth creates new job opportunities throughout the economy, plant closings and industrial reorganization can cause severe hardships for communities dependent on local textile and apparel firms. It also appears that the skills likely to be needed by future textile and apparel enterprises may require extensive training programs even for workers remaining in the industry.

The present state of the U.S. textile and apparel industry presents Congress with difficult choices on trade policy and on government support for research and development. We trust that this special report will provide a framework for making such decisions.

This special report supports a larger OTA project that analyzes the effects of technological change and international trade on the structure of the domestic economy and options for public policy. The textile and apparel industries were selected for special attention because they provide key insights into the problems of changing manufacturing enterprises.



JOHN H. GIBBONS  
*Director*

## List of Reviewers

Gorden A. Berkstresser  
Professor  
School of Textiles  
North Carolina State University  
Raleigh, NC

Peter Butenhoff  
Manager  
International Trade Affairs  
E.I. du Pont de Nemours & Co.  
Wilmington, DE

Michael J. Copps  
Director of Government Affairs  
Collins & Aikman Corp.  
Washington, DC

Henrietta Dabney  
Director  
Research Department  
Amalgamated Clothing and Textile Workers'  
Union  
New York, NY

Maria Fernandez-Kelly  
Professor  
Department of Geography and Environmental  
Engineering  
The Johns Hopkins University  
Baltimore, MD

James A. Parrott  
Economist  
International Ladies' Garment Workers' Union  
New York, NY

James Plouffe  
Manager  
Textile Fibers Division  
E.I. du Pont de Nemours & Co.  
Wilmington, DE

Nicholas C. Williamson  
Professor  
Management Department  
University of North Carolina at Greensboro  
Greensboro, NC

George Wine\*  
Chief Economist  
American Textile Manufacturers Institute  
Washington, DC

---

\*Material supplied by the American Textile Manufacturers Institute included comments from several reviewers under George Wine's auspices.

# **The U.S. Textile and Apparel Industry: A Revolution in Progress** **OTA Project Staff**

Lionel S. Johns, *Assistant Director, OTA*  
*Energy, Materials, and International Security Division*

Henry Kelly, *Project Director*  
*Technology and the American Economic Transition*

**Ruth Ruttenberg, *Contractor***

Gordon A. Berkstresser, *Contractor*

Daniel Chenok, *Research Assistant*

Andrew Wyckoff, *Analyst*

Phyllis Brumfield, *Administrative Secretary*

## **Contributors**

N.C. Williamson

L. Michael

A.R. Barrier

# Contents

<i>Chapter</i>	<i>Page</i>
<b>I. Overview . . . . .</b>	<b>O . . . . . 3</b>
An Industry in Transition . . . . .	3
The Challenge From Abroad . . . . .	4
Linkages to the Rest of the U.S. Economy . . . . .	6
The Impact on the U.S. Labor Force . . . . .	7
The Impact on the U.S. Consumer . . . . .	8
Looking to the Future: Alternatives for Policy . . . . .	9
A Guide to This Report . . . . .	11
<b>2. The U.S. Textile and Apparel Industry: Technology and Structural Change . . . . .</b>	<b>15</b>
U.S. Markets for Textiles and Apparel . . . . .	16
Characteristics of the Domestic Marketplace . . . . .	16
Trends in Consumer Purchasing . . . . .	17
A Technological Revolution . . . . .	18
New Production Technologies . . . . .	19
Consistency, Standardization, and Quality . . . . .	22
Coordination and "Quick Response" . . . . .	23
Industrial Structure . . . . .	29
Background . . . . .	29
Structural Changes . . . . .	31
Trends in investment and Disinvestment . . . . .	32
Into the Future . . . . .	33
<b>3. The Major Industry Sectors: Fiber, Fabric, Finished Products, and Machinery Manufacturing . . . . .</b>	<b>37</b>
The Production of Fiber . . . . .	37
Background . . . . .	38
Technological Innovations. . . . .	42
Industrial Structure . . . . .	46
Textile Mill Products . . . . .	49
Background . . . . .	49
<b>Technological Innovations . . . . .</b>	<b>51</b>
Industrial Structure . . . . .	59
End Uses of Textiles . . . . .	61
Industrial Structure . . . . .	62
Pending Technology . . . . .	67
Textile Machinery Manufacture . . . . .	74
Background . . . . .	74
Industrial Structure . . . . .	75
<b>4. Areas for Decision: Trade, Technology, and Employment . . . . .</b>	<b>79</b>
Declining Trade Balances Shake Textile and Apparel Markets . . . . .	79
The Emergence of a Global Textile Industry . . . . .	81
U.S. Response . . . . .	87
Trade and the U.S. Consumer . . . . .	92
The Adequacy of Domestic Innovation and Capital Investment . . . . .	94
Research and Development. . . . .	94
Capital Investment Uneconomic Necessity . . . . .	95
Implications for the Textile and Apparel Labor Force . . . . .	96
Employment Changes Within the Industry . . . . .	96

## Contents—continued

	Page
Impact on Individuals and Families . . . . .	98
Impact on Communities and Regions of the Country. . . . .	98
<b>5. Policy and Survival. . . . .</b>	<b>103</b>
Employment Issues . . . . .	103
Assistance for Textile and Apparel Workers . . . . .	103
State and Local Responsibilities for Employment Training and Transition . . . . .	105
Trade Adjustment Assistance . . . . .	105
Trade Alternatives . . . . .	106
Export Promotion. . . . .	107
Import Regulation . . . . .	108
Other Trade Policy Areas . . . . .	109
Research and Development . . . . .	110
Public/Private Ventures . . . . .	110
Investment Incentives . . . . .	111
Other Strategies . . . . .	111
<b>Glossary . . . . .</b>	<b>115</b>

### **Boxes**

<i>Box</i>	<i>Page</i>
A. The Evolution of the Multi-Fiber Arrangement . . . . .	86
B. Trade Regulations That Affect Textiles and Apparel . . . . .	89
C. Current Federal Programs for Job Transition . . . . .	106

### **Figures**

<i>Figure No.</i>	<i>Page</i>
1. Constant Dollar Value-Added per Full-Time Equivalent Employee: Manufacturing, Apparel, and Textiles . . . . .	4
2. U.S. Textile and Apparel Trade . . . . .	5
3. Textiles and Apparel Compensation per Full-Time Equivalent Employees a Percent of Compensation per Full-Time Equivalent Employee in All Manufacturing . . . . .	7
4. Change in Full-Time Equivalent Employment Resulting From Changes in Trade and Productivity Levels, 1972 and 1984, for Textiles and Apparel . . . . .	7
5. Price index for Apparel . . . . .	8
6. Personal Expenditure on Clothing and Accessories. . . . .	8
7. Personal Expenditure on Textiles (Home Furnishings) . . . . .	8
8. U.S. Market in Textiles and Apparel . . . . .	9
9. Apparel As Percent of Total Consumption by Income Cohort, 1982 . . . . .	18
10. New Capital Expenditures and Productivity . . . . .	21
11. The Apparel Pipeline at a Glance: Present System v. Quick-Response Strategies . . . . .	24
12. Retailers' Sourcing Cost Comparison: United States v. Far East . . . . .	25
13. Breakdown of Original Retail Price . . . . .	28
14. (TC) <sup>2</sup> Automated Sewing System . . . . .	72
15. Price indices for Clothing . . . . .	93
16. The Geographic Distribution of Textile Employment by State . . . . .	99

### **Tables**

<i>Table No.</i>	<i>Page</i>
1. Full-Time Equivalent Jobs Created by \$1 Million of Output in Textile and Apparel Enterprises in 1984 . . . . .	6

## Contents—continued

<i>Table No.</i>	<i>Page</i>
2. New Capital Expenditures and Productivity . . . . .	20
3. SIC Codes for Textiles and Apparel . . . . .	30
4. Permanent Plant Closings in the U.S. Textile Industry, 1983-June 1985. . . . .	32
5. Number of Establishments and Production Workers, by Type of Establishment, Women's Outerwear Industries, 1963-82 . . . . .	63
6. Branches of the Apparel (Knit and Woven) Industry, by Standard Industrial Classification Code Number . . . . .	64
7. Number of Establishments Per Company, Apparel (Knit and Woven) Industries, United States, 1982 . . . . .	65
8. Apparel Industry in the United States, Production Measures, 1967-84 . . . . .	66
9. U.S. Textile and Apparel Trade . . . . .	80
10. The U.S. Textile Market . . . . .	80
11. U.S. Apparel and Apparel Fabric Market . . . . .	80
12. U.S. Industrial and Home furnishings Market . . . . .	81
13. U.S. and EEC Imports From Developing Countries Dollars Per Capita, 1980-84 . . . . .	87
14. Percent Share of Exports of Textiles and Clothing From Developing Countries by Major Developed Country Markets, 1980-84 . . . . .	87



---

**Chapter 1**  
**Overview**

# Chapter 1

## Overview

---

Providing nearly 2 million jobs, America's textile and apparel enterprises remain a critical part of the national economy—but technology and international competition are forcing the industry through its most profound transformation since the industrial revolution.<sup>1</sup> While forces leading to change have been gathering strength for a generation, the pace increased sharply in the early 1970s. These changes are affecting the nature of products produced; how they are produced; how they are marketed; the structure, scale, and scope of the enterprises producing them; and the nature of jobs created directly and indirectly by the industry. Although much of this change may be beyond the control of public policy,

<sup>1</sup>Unless specifically cited in a note in this section, data described in this summary are documented in later sections of the report and are not separately referenced.

the policy decisions of the next few years could have a critical effect on the industry's future,

The United States is one of the few nations that has left its markets largely open to foreign sales of textiles and apparel, and one of the few that has paid little attention to the research needs of its domestic industry. As a result, imports have flooded domestic markets. Unless policy action is taken in the next few years, there is reason to be concerned about the very existence of many parts of the industry. While it is reasonable to debate whether the Federal Government should act to preserve U.S. textile and apparel enterprises, it is becoming increasingly unlikely that the industry will be able to maintain its present position in the U.S. economy without action to counter the rising tide of imports.

### AN INDUSTRY IN TRANSITION

The U.S. textile and apparel industry is acting quickly to regain its ability to serve previously secure markets. The industry that produces chemical fibers for textiles, which represents a growing fraction of U.S. products, is a world leader in new product ideas. Measured in terms of output per person-hour, the U.S. textile industry is among the most productive in the world—and it continues to modernize, investing about \$1.5 billion per year in new plant and equipment. Personal spending for textile and apparel products has grown sharply since the early 1960s, although net profits from the sale of textiles have not changed significantly during the past two decades<sup>2</sup>.

Significant new technologies include water- and air-jets, which have replaced shuttles; robots that deliver materials and splice broken yarn; computers that design fabric and lay patterns on material; and advanced spinning methods. More uniformity in the quality of natural materials, along with increased use

<sup>2</sup>U.S. Congress, Congressional Budget Office, *Has Trade Protection Revitalized Domestic Industries?* (Washington, DC: U.S. Government Printing Office, November 1986), p. 34. Profits measured in terms of constant dollars.

of synthetics, has facilitated greater automation throughout the fabric formation process. There has been a sharp increase in “nonwoven” fabrics assembled without weaving. Moreover, while labor productivity in textiles is half the average of that in all manufacturing industries, textile productivity has increased at twice the average manufacturing rate for over a decade (see figure 1). There is no sign that the pace is diminishing.

Productivity in apparel assembly, which still utilizes mostly hand-work and sewing machines, also advanced faster than the manufacturing average between 1975 and 1985. Computer-assisted cutting machines, robotic substitutes for labor-intensive materials handling, and stitching operations promise dramatic gains in the near future. A fundamental breakthrough seems to have been achieved in the vexing problem of handling a single ply of limp material. For years, mechanical equipment has easily handled and positioned rigid metal and paper; until recently, however, machines lacked the dexterity to handle cloth. A robotic sewing technology that will soon be ready for commercial use promises to bring substantial increases in sewing productivity.

**Figure 1.—Constant Dollar Value-Added per Full-Time Equivalent Employee: Manufacturing, Apparel, and Textiles**

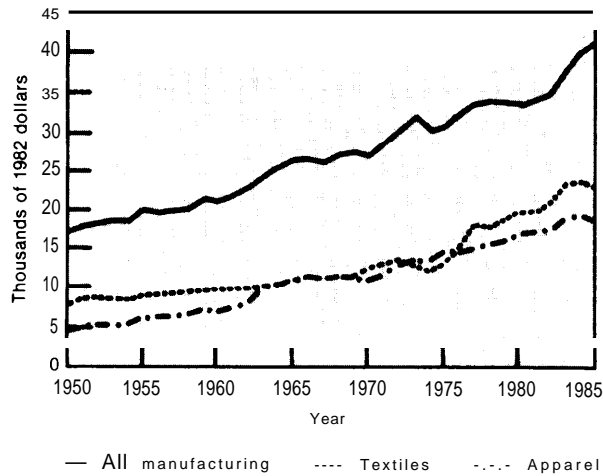

SOURCE: U.S. Department of Commerce, Bureau of Economic Analysis, "National Income and Product Accounts," Survey of *Current Business*, July 1966, tables 6.2 and 6.7B.

Actual sewing accounts for less than a quarter of the time required in apparel assembly. The remaining time involves a series of materials handling steps that could be streamlined through automation and improved management. New, "quick response" information technologies have the potential to unite the entire fiber-to-textile-to-apparel-to-retail network in ways that could make the system operate more efficiently as a whole, with greater responsiveness to rapidly changing consumer tastes and preferences. Already, forced markdowns and stock-outs—responsible for estimated losses of \$14.6 billion and \$8 billion in 1985 retail sales, respectively—have been reduced, by both improved management practices and new equipment that allows for low-cost, small-scale batch runs and rapid reorders. And Wal-Mart has successfully tested a prototype, automated retail system now being investigated actively by major retailers; the system is likely to be improved through greater use of computer-readable tags on retail products and sophisticated communication systems.

### **The Challenge From Abroad**

In spite of these remarkable advances, the industry is gravely threatened. Tariffs, the Multi-Fiber Arrangement—a set of guidelines that allows developed countries to regulate most textile and apparel

imports—and other complex attempts at protection have not stemmed the flood of imported textile and apparel products. Measured in square yards, 33 percent of the U.S. textile market and 48 percent of the U.S. apparel market was imported in 1985, shares that have more than doubled since 1975. This rate of erosion of domestic market shares shows no sign of diminishing. In fact, if penetration of U.S. apparel markets were to continue at the pace of the past decade (measured in terms of volume), domestic sales of U.S. apparel firms would approach zero by the year 2000, while two-thirds of the U.S. textile market would be served by imports. Moreover, much of the technology that has made the U.S. textile industry among the most productive in the world has been purchased overseas. Such problems have been compounded by America's comparatively insignificant textile and apparel exports—when apparel exports reached an all-time high in 1980, for example, they amounted to roughly 3 percent of domestic apparel production.

Because of the relatively low cost of imported products, the trade imbalance is somewhat less when measured in dollars instead of volume. In dollar terms, textile imports represent roughly 6 percent of domestic textile consumption, and apparel imports about 20 percent of domestic apparel consumption; much of the difference between dollar and volume measurements can be attributed to the continued ability of U.S. firms to compete in markets for high-quality, high-price products. Still, if apparel imports are taken in terms of garment purchases at the retail level, their domestic market share rises to approximately one-third. Overall, the 1986 U.S. trade deficit in textiles and apparel exceeded \$21 billion—a fourfold increase since 1980 (see figure 2).

The factors behind this dramatic rise in U.S. purchases of foreign textile and apparel products are complex. The strength of the dollar between 1980 and 1985 made imports far less expensive, relative to domestically produced items. The recent fall in the dollar's value with respect to the currencies of industrial nations will tend to provide only modest relief; much of the growth in U.S. imports has come from nations like Korea, Hong Kong, and Taiwan, whose currencies are either tied to the dollar or have not changed significantly with respect to the dollar. And changes in the value of currencies may have a greater effect on the profitability of foreign manu-

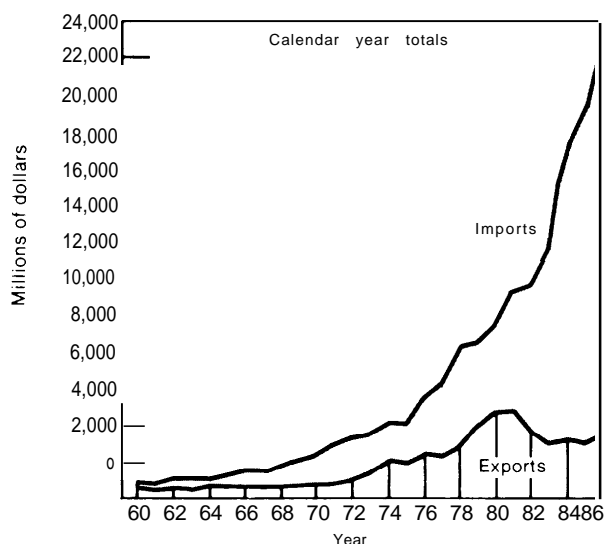
**Figure 2.— U.S. Textile and Apparel Trade**

SOURCE U.S. Department of Commerce, FT.135, FT.140, SITC Classification 65 and 84

facturers or U.S. retail operations than on consumer prices.

At the same time, as other countries began to close their borders to textile and apparel imports, the United States maintained its support for open markets, opting to push for movement toward free trade rather than toward protection and government intervention. Several European economists have commented that:

the United States government persistently opposed the concept of direct government intervention of the types undertaken by its counterparts in Europe and in the Asia Pacific Region.<sup>3</sup>

Indeed, in addition to the obvious economic stimulus that the textile industry gives to developing economies, many developed nations view the industry as critical to their economic vitality. Since 1983, the European Economic Community (EEC) has strengthened import restrictions significantly, pursuant to bilateral agreements negotiated under the Multi-Fiber Arrangement (MFA). Japan restricts imports more informally—by placing pressure on the distribution network, and by concluding a variety of non-MFA bilateral restraint agreements. Available evidence

suggests that the EEC's adoption of a more restrictive regime under the MFA as of 1983, coupled with Japan's continuing restrictions, has had the effect of channeling developing nation textile and apparel exports into the U.S. market.

In particular, the U.S. manmade fiber industry depends on international developments throughout the domestic textile and apparel industry complex. Technology for producing a variety of fibers is available worldwide. A number of nations are rapidly expanding production, substituting their own products for U.S. fibers. The world market share of U.S. production of "noncellulosic" fiber—including nylon, acrylic, and polyester—fell from 33 to 23 percent between 1979 and 1985. During the same period, China increased noncellulosic production by 361 percent, India by 203 percent, and Indonesia by 102 percent; China expects to be self-sufficient in the near future.

The fact that China and Australia are the world's leading producers of two important natural fibers—cotton and wool, respectively—accentuates this growing competition. Moreover, many developing nations, which hope to stimulate their domestic economies by retaining more of the value added during textile and apparel production, are investing heavily in production facilities for manmade fibers. U.S. imports of synthetic textiles and apparel grew from about 3 billion to 5.5 billion square yards between 1979 and 1984.

New textile and apparel production equipment moves into world markets rapidly. Many of the productivity gains enjoyed by the U.S. textile industry have resulted from equipment purchases from West Germany, Switzerland, Japan, and even Czechoslovakia. U.S. textile and apparel producers will almost certainly continue to benefit from new devices under development abroad. In addition, many developing nations have access to the same sophisticated machinery that is available to U.S. firms.

On the other hand, U.S. producers of textile machinery have fallen far behind the international state-of-the-art. Their overall share of the domestic market has fallen from 93 percent in 1963 to 55 percent today; the United States produces none of the advanced shuttleless looms that are revolutionizing weaving. What remains of the industry is not particularly encouraging. Over 92 percent of the export sales of domestic textile machinery firms went to supply replacement parts.

<sup>3</sup>BTovneetal, *The Global Textile Industry* (London: George Allen & Unwin, 1984), p. 68

## **Linkages to the Rest of the U.S. Economy**

While employment in domestic wholesale and retail textile and apparel firms—which add over half the value of industry products that are sold to consumers—is not likely to change significantly as the result of trade, the fates of a number of other important U.S. industries are linked closely to that of textiles and apparel. Failure on the part of textile and apparel enterprises can have dramatic effects on the local communities where they operate, especially in the many small towns of the southeastern United States where a textile plant represents the main source of industrial employment. On a larger scale, such effects can propagate throughout the U.S. economy, since only about one-quarter of the value added by production and sales of textile goods and fabricated textile products goes to textile and apparel firms, while only about 40 percent of the value added from production and sales of fabrics and apparel remains within the industry.

The rest of the value from these sales is distributed quite broadly throughout the U.S. economy. A significant portion ends up in the “service” industries, particularly transportation and trade and the highly paid “transactional” services like finance, in-

surance, and business services. To a large degree, the fate of America’s textile and apparel industry—like that of other manufacturing sectors—affects the health of U.S. service industries.

Table 1 reviews some of these linkages in greater detail. The table suggests the number of jobs lost in the U.S. economy from \$1 million of imports in the industries shown, or the number of jobs gained from \$1 million of exports.<sup>4</sup> It indicates that \$1 million of production in the U.S. fabrics sector creates approximately 28 U.S. jobs; this number accounts for the negative effects of trade. Of the jobs created, approximately 60 percent are in the textile and apparel industry. The apparel sector is less linked with businesses outside textiles and apparel, as 70 percent of the jobs created by output from apparel production remain within the industry.

These calculations do not account for purchases needed to modernize plants or replace depreciated equipment. Adjusting for purchases of capital equipment is a difficult undertaking, given the poor qual-

<sup>4</sup>Since the details of the products exported and imported in any industrial category differ, the number of jobs created and lost from \$1 million of trade are necessarily different. But because the data available cannot be disaggregate beyond the categories shown, the effect of differences in the composition of exports and imports within the input/output categories exhibited cannot be shown

**Table 1.—Full-Time Equivalent Jobs Created by \$1 Million of Output in Textile and Apparel Enterprises in 1984 (including trade effects outside textiles and apparel)**

	Classification <sup>a</sup>			
	Fabrics	Textile goods	Apparel	Fabricated textiles
Natural Resource Intensive <sup>b</sup> .....	1.4	1.2	0.7	0.9
Construction.....	0.4	0.4	0.3	0.3
Manufacturing <sup>c</sup> .....	20.1	18.4	24.1	22.6
Low wage.....	(16.8)	(14.0)	(22.3)	(20.0)
Medium wage.....	(0.6)	(0.8)	(0.5)	(0.7)
High wage.....	(2.7)	(3.6)	(1.3)	(1.9)
Trade & transportation.....		4.0	3.2	3.8
Transactional services <sup>d</sup> .....	1.7	1.5	1.6	1.6
Personal services <sup>e</sup> .....	0.4	0.4	0.4	0.5
Social services <sup>f</sup> .....	0.5	0.5	0.5	0.5
<b>Total.....</b>	<b>28.2</b>	<b>26.4</b>	<b>30.8</b>	<b>30.2</b>

NOTE: Read the table as follows: \$1 million dollars in output in the U.S. fabric industry generates a total of 28.2 jobs, of which 1.4 were in natural resource intensive industries, 0.4 were in construction, etc.

<sup>a</sup>Industry classifications accord to two input-output tables provided by the U.S. Department of Commerce

<sup>b</sup>Mostly agriculture and mining

<sup>c</sup>Manufacturing is divided into Low Wage (mostly textiles, apparel, and wood products), Medium Wage (mostly ‘high tech’ machinery), and High Wage (mostly ‘heavy’ manufacturing)

<sup>d</sup>Media, finance, real estate, and business services

<sup>e</sup>Hotels, auto repair, household industries, and amusements

<sup>f</sup>Includes government and private sector

SOURCE: Office of Technology Assessment, 1987. Compiled from 1980 Input/Output relationships provided by the Bureau of Economic Analysis, U.S. Department of Commerce; 1984 productivity levels and estimated trade statistics provided by the Bureau of Labor Statistics, U.S. Department of Labor.

ity of available data. Still, 1977 purchasing patterns suggest that \$1 million of output in fabric and textile goods production—adjusted for 1984 trade patterns—would generate another five jobs in enterprises supplying production equipment, mostly in medium- and high-wage industries and transportation. Since apparel production is not heavily capitalized, including the effects of capital equipment purchases for these industries would create few additional jobs.

### **The Impact on the U.S. Labor Force**

Growth in domestic demand has partially offset employment loss resulting from increases in imports and productivity. But between 1980 and 1985, employment in the apparel industry fell 11 percent, and textile employment fell 15 percent. A total of 142,000 jobs were lost. It is important to note, though, that many of the jobs eliminated by automation were dangerous and unpleasant. The threat of “brown lung” that haunted the industry for years has been reduced significantly through the use of machines for tasks that would pose health and safety threats to human operators.

The combined effects of new technology and pressure from imports have also had a sharp effect on industry wages. As a percentage of wages for all manufacturing industries, wages and other forms of compensation for textile workers (measured in current dollars) have fallen steadily since the late 1960s (see figure 3)—despite the rapid growth of labor productivity in textiles.

Undoubtedly, pressure from imports was at least partly responsible for the inability of U.S. workers to enjoy greater benefits from productivity growth. And U.S. apparel workers have been the victims of that industry’s intensive struggle to maintain its competitive position—they have seen a significant decline in average real wages. Relatively stable during the 1960s, average apparel compensation fell from 62 percent of the U.S. manufacturing average in 1970 to 52 percent in 1985 (again see figure 3). Some have charged that this problem has been accentuated by the recent rise in the use of “subminimum” wages, as well as growing complaints about employer violations of overtime regulations. j

<sup>j</sup>International Ladies’ Garment Workers’ Union, Research Department, “The U.S. Apparel Industry, 1960-1985, With Special Emphasis on Women’s and Children’s Apparel,” Oct 18, 1985, p 1(1)

**Figure 3.—Textiles and Apparel Compensation per Full-Time Equivalent Employee As a Percent of Compensation per Full-Time Equivalent Employee in All Manufacturing<sup>a</sup>**

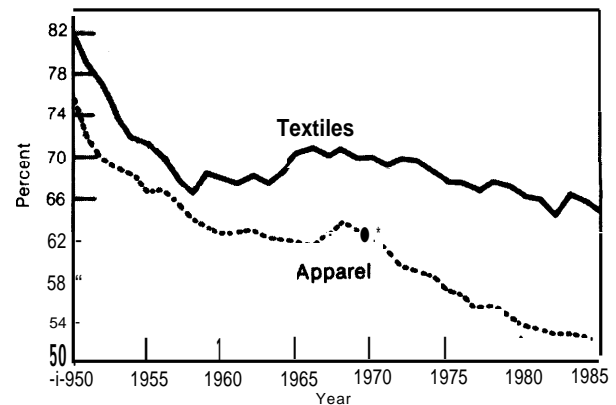

<sup>a</sup>Includes wages and other forms of compensation

SOURCE: U.S. Department of Commerce, Bureau of Economic Analysis, “National Income and Product Accounts,” Survey of Current Business, July 1986, tables 67 and 68

Job losses resulting from imports cannot be easily disentangled from those resulting from rising domestic productivity. While trade clearly stimulated technological change in the domestic industry, for example, both trade and technology stimulated price reductions that increased domestic demand. Figure 4 compares trade and productivity effects; clearly, the data provide only a crude approximation of how

**Figure 4.—Change in Full-Time Equivalent Employment Resulting From Changes in Trade and Productivity Levels, 1972 and 1984, for Textiles and Apparel**

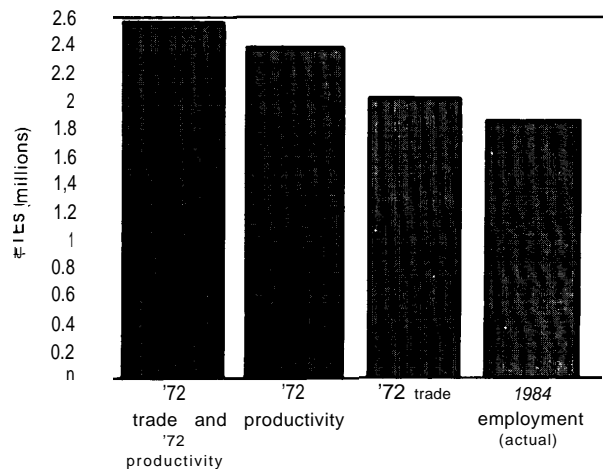

SOURCE: Office of Technology Assessment, based on data provided by the U.S. Department of Commerce and U.S. Department of Labor 1987

these factors have affected job losses among U.S. textile and apparel enterprises.

All four bars in the figure assume that domestic demand for textiles and apparel remained as it was in 1984. The bar on the far right assumes that trade and productivity levels also matched those of 1984, while the bar on the far left suggests what might have occurred if 1972 patterns of trade and productivity had existed in 1984—a hypothetical gain of approximately 700,000 jobs. The intermediate bars suggest that more jobs have been lost due to investment in automation than to the effects of trade.

Tomorrow's textile and apparel jobs are unlikely to provide as many low-paid, entry-level positions for immigrants and minorities as they have in the past. Increasingly, technicians and highly trained operators may substitute for people with more traditional skills, who—without appropriate retraining—could see traditional employment opportunities move into overseas, low-wage production facilities. In this sense, U.S. textile and apparel enterprises that continue to operate as they have for generations might not survive except through the most draconian of public intervention. Firms that do remain may have to transform their operations in fundamental ways.

**The Impact on the U.S. Consumer**

While there is reason to doubt that consumers have been given full advantage of the comparatively low price of imported textiles and apparel, there is

little doubt that American consumers have benefited enormously from the changes taking place in the industry. The price index of apparel, or the rate at which apparel prices change, has dropped sharply as a percentage of the overall rate of inflation since 1970 (see figure 5). Although the real impact of import quotas and tariffs on the price paid by consumers is difficult to estimate, one analysis suggests that even during periods of strong demand, trade quotas increase domestic clothing prices by 10 percent at most.<sup>6</sup>

<sup>6</sup>D. Kessing and M. Wolf, "Textile Quotas Against Developing Countries" (London Trade Policy Research Center, 1980).

**Figure 6.— Personal Expenditure on Clothing and Accessories**

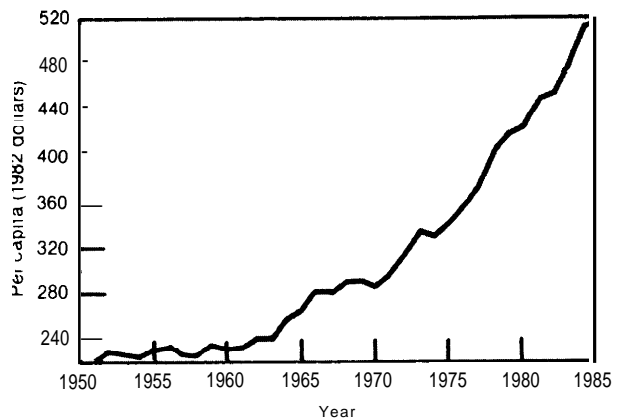

SOURCE: U.S. Department of Commerce, Bureau of Economic Analysis, "National Income and Product Account s," Survey of *Current Business*, July 1986, table 2.5

**Figure 5.— Price Index for Apparel (fraction of price index for all personal consumer expenditures)**

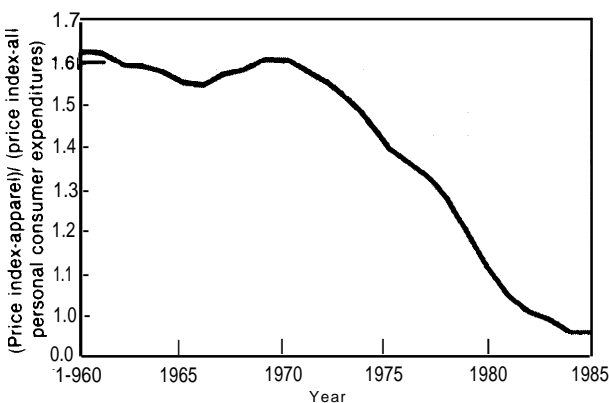

SOURCE: U.S. Department of Commerce, Bureau of Economic Analysis, "National Income and Product Account s," Survey of *Current Business*, July 1986, tables 24 and 25 (1982 = 1.00).

**Figure 7.— Personal Expenditure on Textiles (Home Furnishings)**

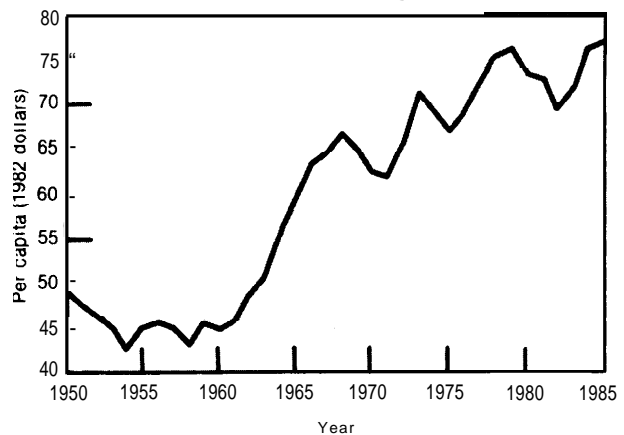

SOURCE: U.S. Department of Commerce, Bureau of Economic Analysis, "National Income and Product Account s," Survey of *Current Business*, July 1986, table 2.5.

Measured in dollars of purchases, personal spending on apparel and other textile products has increased rapidly (see figures 6 and 7), even though per-capita volume purchases have remained relatively stable in terms of raw volume (see figure 8). This means that many purchasers have turned to more expensive products. However, such a devel-

opment must be viewed with caution. Many high-priced American goods are sold by U.S.-owned firms that do much of their production overseas. This "offshoring" of production allows U.S. companies to benefit from lower wages abroad, since firms may use lower labor input costs to increase profits while retail prices are held steady.

Figure 8.— U.S. Market in Textiles and Apparel

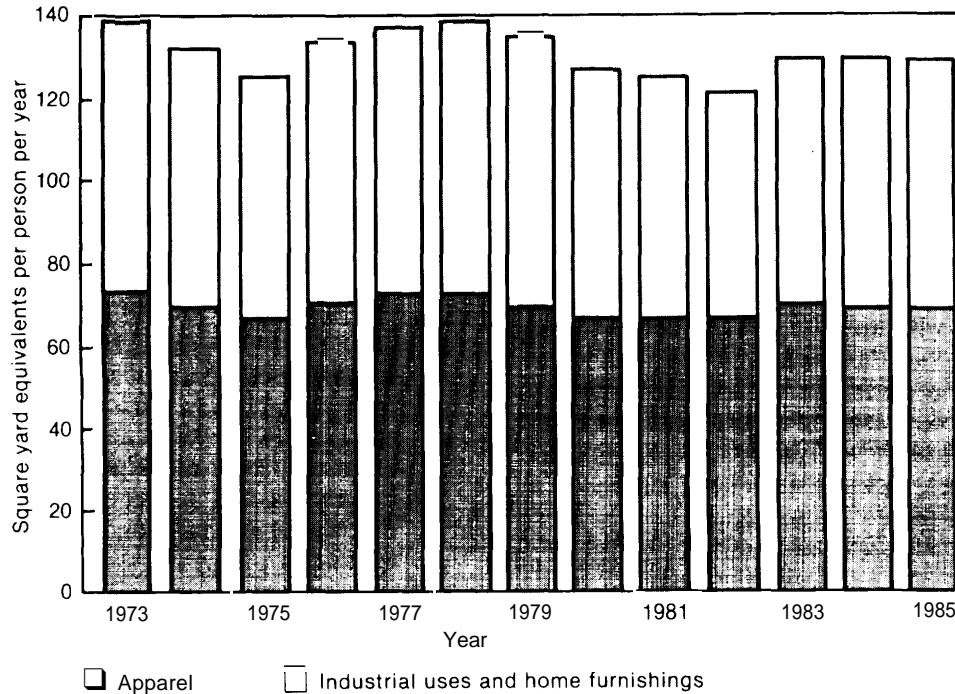

SOURCE Office of Technology Assessment, based on data provided by the American Textile Manufacturers Institute, 1987

## LOOKING TO THE FUTURE: ALTERNATIVES FOR POLICY

Whatever the future may bring, the next generation of U.S. textile and apparel enterprises is likely to be almost unrecognizable, measured by both the nature of the jobs that will be created and the nature of the firms that will prosper:

- 1. Jobs:** Productivity growth is likely to continue to outstrip growth in domestic demand. As a result, domestic jobs will continue to be lost even if trade penetration levels return to those of the early 1970s.
- 2. Business structure:** Midsize U.S. companies are being squeezed, in part by the versatility

and low capital needs of many small firms and in part by the power and scale of increasingly large integrated corporations. Indeed, horizontal and vertical integration are changing the very structure of the industry.

In the face of these developments, Congress must grapple with a series of uncomfortable dilemmas. Should the United States intervene in domestic and international markets in order to save an industry with comparatively low wages and productivity? Given that a number of developing nations, including China, are attempting to use exports of textiles and apparel to stimulate domestic economic develop-



ment—and are willing to go to extreme lengths to protect domestic industries and promote exports—can the U.S. industry ever compete successfully? In Pakistan, for example, more than half of all industrial employment is associated with textiles and apparel. Can the United States suggest alternative methods for promoting economic development in these nations? If short-term protection is provided, can the U.S. industry reshape itself so that it could survive without long-term import restrictions? If such protection is provided, can the industry be given adequate incentives to make needed investments? None of these issues have unambiguous answers.

It is possible, however, that given creative industry management and appropriate public policy, U.S. textile and apparel enterprises can continue to be a significant part of the U.S. economy without strong protection over the long term. While the burden of responsibility for building a competitive industry rests primarily with industry management—its willingness to innovate, take risks, and rethink old patterns of industrial organization—appropriate government actions could facilitate the process, or could buy time for the textile and apparel industry to make needed changes. Options have been suggested in the following areas.

1. Programs to protect the domestic industry from imports in the near term could include:
  - tougher enforcement of bilateral trade agreements and the Multi-Fiber Arrangement;
  - expansion of Multi-Fiber Arrangement coverage to fibers not presently controlled;
  - an import licensing system to help prevent overshipments, which might also limit the growth of textile and apparel imports to the growth of the U.S. market;
  - mandatory retaliation, in the form of quotas or other measures, against nations judged to be “dumping” in the United States, or engaging in unfair trade practices;
  - defining “unfair trade practices” to include denial of basic labor rights and standards; or
  - negotiated increases in tariffs.

The wisdom of such measures should be weighed in the context of overall U.S. strategy in international trade. Foreign retaliation against protection for textile and apparel enterprises could affect America’s ability to reduce trade barriers in other industries.

2. Encouraging a strong industry commitment to retrain people displaced from traditional textile and apparel jobs could help these workers find new jobs, some of which might be in a rebuilt and more sophisticated textile and apparel industry.
3. An ambitious program for research and development in areas related to textile and apparel production could be implemented, in order to rebuild U.S. technical capabilities in the manufacture of textile machinery equipment and to ensure that U.S. production leads the world in state-of-the-art technologies. Programs might include designating several “centers of excellence” for research and development, in areas like apparel assembly technology, sensors and handling systems for limp fabrics, and computer-assisted design of apparel and fabrics. The Textile/Clothing Technology Corp.’s [(TC)<sup>2</sup>] remarkable success in combining government, industry, and union support in the development of advanced sewing equipment provides an instructive example on which to build; Japan and several European nations are investing large sums to develop new machinery.
4. Programs could be established to facilitate industrywide cooperation and standard-setting, leading to a “quick response” system capable of tying apparel and textile product retailing operations with apparel and textile production facilities. “Quick response” could provide flexibility to respond to shifting domestic markets that are best understood by producing close to consumers.
5. A macroeconomic policy could be designed to encourage industrial research and private sector investment in innovative technology.

These options would take time to implement, and some may require increases in Federal funding for research and training. They depend on flexibility and imagination in private management. Above all, they require confidence in the future of the industry. The analysis presented in this report suggests that appropriate public policy can help to justify such confidence.

Indeed, an array of new production and control technologies—coordinated through a “quick response” network that can reduce the distance between producers and retailers—may greatly expand the range

of product areas in which U.S. producers are competitive. Given implementation of this integrated U.S. system, foreign low-cost producers could lose market share in all but the most labor-intensive products and specialties. A “quick response” system, of course, could add significantly to domestic communications and transportation costs, and could increase demand for sophisticated local management. As a whole, however, “quick response” technologies may significantly reduce, and in some cases eliminate, the price advantages of low wage competitors—even under current conditions.

## A GUIDE TO THIS REPORT

The first part of this special report examines the textile and apparel industries as they exist today, their structure (ch. 2), and the forces of change already at work (ch. 3). Major areas where policy decisions will be needed are examined in the second half of the document. Trade, technology, employment, and marketing are addressed in chapter 4, followed by a review of policy options and the barriers that need to be addressed in order to achieve effective change (ch. 5).

Throughout this study, the term “textile” is often used to represent the entire industry complex: from fiber, to fabric, through the end uses of apparel, home furnishings, and industrial products. “Fiber” refers to the initial production phase, be it woven, nonwoven, natural, or synthetic material. “Fabric” and textile mill products are used interchangeably, and sometimes the term “textile” is specifically focused on this phase of production. “End uses” refers

to all textile products ready for application, be they apparel, home furnishings, industrial goods, or some new and innovative function like chemical reagents. The terms “synthetic” and “manmade” are used interchangeably, and include both cellulosic and non-cellulosic fibers.

One methodological problem in studying the textile industry complex deserves special note. Production and consumption statistics are available in many different units, ranging from dollar value, to yards, to square yard equivalents, to pounds. Clearly, for any given analytical issue the measure chosen can affect the statistical outcome—sometimes significantly. If all data were available in square yard equivalents, that would probably be the measure of choice. But this is not the case, and this special report uses a variety of measures, of which the reader should be aware while forming his/her own conclusions.

---

**Chapter 2**

**The U.S. Textile and Apparel  
Industry: Technology and  
Structural Change**

# The U.S. Textile and Apparel Industry: Technology and Structural Change

---

*Chemicals and robots make our clothing, rather than cotton and the sewing machine. Manual labor has been virtually eliminated in the production of textiles and apparel, except in design and equipment maintenance. Few communities are known as “textile towns.”*

*Fiber companies, textile producers, apparel manufacturers, and retailers are tied together through sophisticated communication networks, and react almost instantaneously to market trends. Customers enjoy more products tailored to their **specific tastes**, and find a greater range of styles and sizes in stock. However, demand for blouses and slacks may not be as great as demand for the textiles and fabrics used in road construction and rocket ships.*

*A proliferation of export incentives and import protections among nations of the world has made public policy nearly as important as traditional economic forces. “Made in the U.S.A.,” when it appears on a label, may not ensure that all stages of production occurred within U.S. borders. The domestic industry is comprised of large multinational corporations and small contract shops. Mid-size firms, the backbone of the industry for two centuries, have all but vanished.*

Could this be part of the future of the U.S. textile and apparel industry? While there are certainly exceptions to such a vision of the U.S. industry in the 21st century, most experts predict a vastly altered industrial landscape for the future—one in which the economic, technological, and public policy influences on production are radically changing the industry, much as the forces of the industrial revolution did 200 years ago. The industry is being reshaped by technology, the growth of international trade, changing patterns of demand, and a shifting regulatory environment. These forces affect what is being produced, how it is produced, and who is doing the work. They are changing the structure of both individual businesses and whole business sectors.

The network of industries that deliver apparel, home furnishings, and other woven and knitted products to final markets is extraordinarily complex. The diversity of this system is both an asset and a liability.

The system has enjoyed enormous flexibility, and has matched products to markets despite constant changes in styles, tastes, and production technologies.

The industry begins with the production of fiber from either natural or “manmade” (synthetic) materials; typically, manmade fiber companies are large and sophisticated chemical firms. Raw fiber is spun, woven, knitted or otherwise converted into fabric by another set of enterprises—primarily textile mills, which can be very small or very large enterprises. This fabric must be converted into an apparel product or a product for industrial use; the apparel industry is highly fragmented, and typically operates through a complex series of contracts with “jobbers.” Finally, the product must be transported, warehoused, transported again, and made available to consumers through retail channels.

Each of these industry segments has a unique business structure and management style, each has a unique history, and each is supported by different kinds of technology. Each is affected by trade in different ways. Perhaps most importantly, each is a virtually independent culture. Taken together, however, the industry segments share a common problem: finding the means to prosper in an increasingly competitive international environment by improving the way that U.S. and world markets can be served by domestic production.

The fragmented structure of the industry presents a barrier to technologies that require standardization and integration. This standardization involves agreed improvements in quality and reliability; sophisticated weaving, for example, requires high-quality yarns. Agreed protocols are needed as well, in order to shorten delivery times and reduce inventories. There is no reason why a diverse group of enterprises could not develop a set of standards and communication protocols that would allow the industry as a whole to benefit from new technology, even without large-scale vertical or horizontal integration—indeed, the industry segments are now developing just such standards. There may also be areas where economies

of scale can be enjoyed from greater integration, and a number of mergers have taken place in recent years.

This chapter first examines the nature of the markets served by the combined network of fiber/textile/apparel/retail businesses. Changes in the technology of each industry segment are then described, emphasizing those technologies that must work to-

gether to improve the net productivity of the entire system; details on the equipment used in fiber, textiles, and apparel will be provided in chapter 3. This chapter concludes with an examination of the changes in the structure of each industry component made possible—and in some cases made necessary—by new technology and the new challenges of the global marketplace.

## U.S. MARKETS FOR TEXTILES AND APPAREL

Increasing domestic and international competition, coupled with relatively slow growth in U.S. markets, have forced U.S. apparel producers and retailers to pay close attention to changes in the market. Even textile firms, which have traditionally not tied sales success to market trends, have been forced to account for changing consumer preferences and the growth of specialty market niches. Such developments have evolved from changes in the structure of demand, which result from increased female employment, greater interest in leisure and sports activities, rising education levels, and aging of the population.

The search for a competitive edge has led to greater concern about the growth of forced markdowns and the impact of “stockouts” on lost sales. In response, a growing number of firms are adopting sophisticated market research activities, including test market programs. New technologies can satisfy rapidly changing consumer needs and tastes, allowing U.S. firms to provide a “quick response” to shifting patterns of expenditure.

### ***Characteristics of the Domestic Marketplace***

Domestic markets for apparel can be divided roughly into three categories, each of which present different problems in production and sales:

1. “fashion” products, with a 10-week product life—approximately 35 percent of the market;
2. “seasonal” products, with a 20-week product life—approximately 45 percent of the market; and
3. “basic” products, sold throughout the year—approximately 20 percent of the market.<sup>1</sup>

<sup>1</sup> Estimates based on interviews with industry marketing specialists.

Generally, markets for men’s and children’s clothing are less subject to change from year to year, and are therefore more suited to large-scale production. Women’s garments tend to dominate seasonal sales, which are much more difficult to predict.

While the bulk of the following discussion will concentrate on apparel, it must be recognized that textile markets for products other than apparel are growing rapidly. The home furnishings market—draperies, rugs, sheets, blankets, towels, tablecloths, window shades, wall coverings, and upholstery—is essentially a “basic” market, in that it is both large and relatively predictable; the assembly process is straightforward and highly automated. Many textile companies sell these products directly to retailers.

Textiles are also used for an expanding range of other products, including filters, parachutes, book bindings, fire hoses, adhesive tape, typewriter ribbons, automobile tires, mailbags, electrical insulation conveyor belts, and storage tanks. The safety harness and couch coverings of space crafts are made of textiles. Textiles are used in surgery to replace worn-out body parts, such as blood vessels, and were even part of the first artificial heart. Textiles are instrumental in controlling air and water pollution, in soil conservation, and in flood prevention in the form of inflatable dams. Geotextiles may even be used to help solve the pothole problem.

U.S. producers have remained competitive at the extremes of the domestic market for textiles and apparel. Import penetration is relatively low for basic items like home furnishings, which have an extremely low labor content, and for items like basic men’s wear, where styles change slowly and domestic production is highly automated. U.S. producers are also doing well in such industrial products as

bile upholstery, where the cost of textiles is a small fraction of the total selling costs and where the risks of dealing with low-cost producers are often not worth the small direct savings. Import penetration is also low in certain "fashion" areas—those in which an extremely short selling life complicates dealings with foreign contractors who may need several months to deliver products, and those in which purchasers are comparatively insensitive to price.

In contrast, foreign penetration is highest in seasonal products, particularly private label products; imports of this type may now constitute over 80 percent of the market. Market uncertainty, and virtually no tradition of concern with production technology, mean that domestic labor productivity in the seasonal product sectors is relatively low. This, of course, has resulted in high labor costs, giving low wage foreign producers a competitive advantage against U.S. firms in selling labor-intensive product lines. It is in precisely these seasonal products that new production systems, mostly in the form of "quick response" technologies and strategies, can have their greatest impact.

### ***Trends in Consumer Purchasing***

Overall, textile and apparel demand in the United States in the next decade will likely reflect a stabilization or even a reduction in per-capita consumption growth rates. America's per-capita volume fiber consumption has leveled off, and is now in a slow decline. According to trend estimates by the American Apparel Manufacturers Association (AAMA), apparel consumption is expected to increase in value, but not in unit volume. Consumers are expected to demand more quality in apparel, tending to raise prices while increasing the useful life of the garment. Market analysts portray today's apparel consumer as a comparatively independent shopper with a sophisticated taste level, a high income level, and a high education level. Textile and apparel markets also face the challenging opportunity of the coming of age of the "baby-boomers." With the oldest of the baby-boomers now approaching 40 and the youngest just leaving college, this generation is entering its prime years of earning and spending.

Men and women alike have become more sensitive to the communicative quality of their clothing, and its ability to influence image, career advance-

ment, and self-esteem. By wearing specific clothing, consumers are seeking to convey an image of confidence and attractiveness. Opportunities for individual firms to find successful market niches thus become more significant. There are also indications that mills are learning how to sell—instead of continuing to churn out cloth for a mass market, they are targeting niches not filled by imports.<sup>2</sup>

With consumers placing increasing emphasis on the style and status of clothes, retailers can direct promotion around an image that is "in vogue." Major retailers see the need not only to increase the number of basic textile and apparel lines offered at any given time, but to offer greater variety in color and style within each line; one of the major areas of retail growth has been the smaller specialized stores, which concentrate on a particular line, design, or brand. This trend has forced major retailers to establish a number of smaller boutique areas, offering products to specific customer groups. At the same time, however, department and specialty stores have lost market share to chain outlets and discounters, as well as to nonapparel stores that sell items such as hosiery.

AAMA identifies six trends, both demographic and qualitative, that are likely to influence future trends in apparel purchasing:

1. a major shift to an older population; largest growth in the 35 to 54 age group, who have the most money to spend on apparel—need for greater variety in apparel;
2. more white collar workers—need for more dress apparel;
3. more single people with more money for apparel;
4. shift to more casual and informal wear;
5. shift to better quality and longer life garments; and
6. sportswear and active wear still important—need for more style, higher cost, and more durable items, but not for as many units.<sup>3</sup>

The baby-boom generation is having an enormous influence on markets as it passes through its peak buying years. The number of households with heads

<sup>2</sup>Scott Kilman and Linda Williams, "The New Mill: While Textile Makers Bemoan Imports, They Are Modernizing, Too," *Wall Street Journal*, Sept 14, 1984, p. 1.

<sup>3</sup>"The U.S. Apparel Market," *Apparel Manufacturing Strategies 1984*, report compiled by American Apparel Manufacturers Association,

aged 35 to 44 is expected to increase 44 percent by 2000, and the household age group 45 to 54 is expected to grow by 71 percent;<sup>4</sup> the U.S. Census Bureau has indicated that households headed by individuals between the ages of 35 and 54 have, on average, the highest household income, and spend more on textiles and apparel as a percentage of total expenditures than either younger or older households. Indeed, OTA analyses show that as household income rises, the portion of household spending that goes to apparel also increases—dramatically, in the highest income groups (see figure 9).<sup>5</sup>

<sup>4</sup>U.S. Bureau of the Census, Current Population Reports, Series P-25, No. 986, *Projections of the Number of Households and Families: 1986 to 2000* (Washington, DC: U.S. Government Printing Office, 1986), table 2, Series B.

<sup>5</sup>OTA, collected from U.S. Department of Labor, Bureau of Labor Statistics, "Consumer Expenditure Survey, 1982/83," unpublished data, 1986.

**Figure 9.—Apparel As Percent of Total Consumption by Income Cohort, 1982**

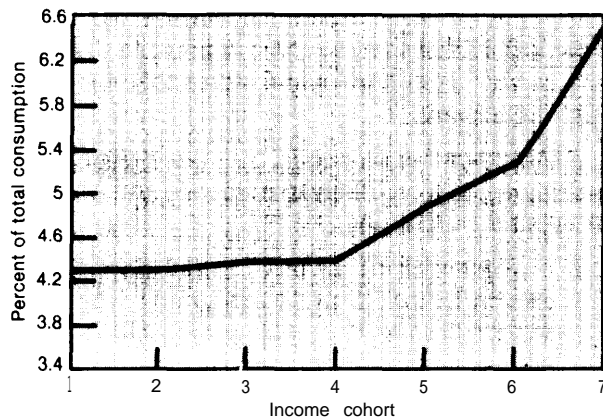

NOTE: Income cohorts divided according to average pre-tax income per person for a "consuming unit," roughly defined as a "household." The figure was calculated, ranked into ascending order, and then split into seven groups with equal numbers of "households" in each group.

SOURCE: U.S. Department of Labor, Bureau of Labor Statistics, "Consumer Expenditure Survey, 1982/83," unpublished data, 1986.

In addition, consumers aged 25 to 44 spend up to 45 percent more than other age groups on furniture and home furnishings, and it will be 20 years before the last baby-boomers leave that high spending category. As the baby-boomers age, they will account for an estimated 4-percent increase in furniture sales in the coming years, and will be particularly attracted to high-priced, high-quality furniture. Clearly, significant opportunities exist for individual firms to find successful market niches—another of which could be in children's apparel, since the growing number of baby-boom families has already translated into a larger share of household spending for infant clothing.<sup>6</sup>

On the other hand, the group which has the largest propensity to spend disposable income for apparel (not including textiles)—generally classified as young adults, under 25 years of age—will decline over the same period. According to the Census Bureau, there will be approximately 1 million fewer household heads in this age group by the year 2000, a loss of 22 percent.<sup>7</sup> And all demographic groups—whether they are based on income, age, marital status, or family age structure—spent less on apparel as a percentage of their total consumption in 1983 than in 1973.<sup>8</sup>

<sup>6</sup>Ibid.

<sup>7</sup>Ibid.

<sup>8</sup>OTA, collected from "Consumer Expenditure Survey, 1972/73 and 1982/83," op. cit.

## A TECHNOLOGICAL REVOLUTION

"For American manufacturers, the choice is clear: modernize or die."<sup>9</sup>

Automation of virtually all textile production processes is underway. The entire manufacturing proc-

<sup>9</sup>Ellison S. McKissick, Jr., president, American Textile Manufacturing Institute, and head of Alice Manufacturing Co. of Easley, SC, cited in Phillip W. Wilson, "Living in a Material World," *World*, March-April 1986, p. 10.

ess is utilizing sophisticated microprocessor-controlled monitoring technology. And all manufacturing technologies are being integrated into flexible units with fewer overall steps. Speed and product quality are improving. New technology is increasing productivity while reducing labor content. Future technologies are expected to be more expensive, which will increase demand for new capital expenditures.

Many experts believe that the U.S. textile and apparel industry must have a technological edge in order to remain competitive in world markets. Maintaining such an edge, however, is increasingly difficult, as technology transfer becomes easier and developing nations make substantial investments in new plant and equipment.

### **New Production Technologies**

Most changes in the technology in place are designed to address three major production issues:

1. reduction of the labor content in the manufacturing process,
2. increase in the quality of products, and
3. flexibility in production.

Since the mid-1960s, process improvements have included the automation of opening rooms, the installation of chute-feeds and high production cards, the partial automation of drawing, the introduction of open-end spinning, the increasing use of shuttleless looms, the use of automatic systems for handling waste, and the nearly universal use of micro-processor-controlled monitoring and reporting of production variables.<sup>10</sup>

In each of the four major processes of cotton textile manufacturing there have been major technological innovations that have substantially increased productivity. The installation of automatic equipment in cotton opening rooms is replacing manual feeding. The use of chute-fed cards eliminates the necessity for manual carding and for most manual cleaning. Open-end spinning is replacing ring spinning for some yarns. In weaving, firms are shifting from shuttle looms to a variety of high-speed shuttleless looms. There have also been major innovations in texturing, new knitting machines, computerized finishing, cutting, and sewing.

### **Productivity Improvements**

Consolidation and modernization have resulted in productivity increases by generating increased output from fewer plants and fewer employees. Productivity growth in the textile mill industry is the highest of all industries in U.S. manufacturing. Between

1975 and 1985, productivity levels in the textile mill industry increased substantially—more than twice that of total manufacturing, or 5.6 percent per year v. 2.4 percent. Even the apparel industry as a whole had higher productivity growth than total manufacturing, at 2.7 percent for the decade (see table 2 and figure 10).

U.S. textile industry productivity also surpasses productivity per employee among the textile industries of the major industrialized nations of the world, according to a 1985 European Economic Community study. The study found that:

... some Western industries—especially the United States’—have achieved considerable gains in productivity thanks to the modernization and automation of their production. In 1980, the U.S. textile industry recorded the highest productivity per employee amongst the major industrialized manufacturing countries, thereby enabling it to achieve the lowest unit production costs amongst the same industrialized countries . . . The labor cost per unit produced in the United States is therefore closer to that of Portugal than that of the major European manufacturers, and closer to the unit cost in Pakistan than to the unit cost in Belgium or Germany. As a result, U.S. producers have been able to achieve price levels approaching those of some “low cost” Asiatic or Mediterranean countries.<sup>11</sup>

Productivity improvements have largely been the result of significantly increased machine speeds and versatility, and improved product quality, energy efficiency, and production efficiency, through both economic and technological consolidation.<sup>12</sup> The major innovations which have increased productivity are high-speed cards, continuous spinning frames, and shuttleless looms. Large- and even some medium-size U.S. companies are well on their way to modernization. On the other hand, many smaller companies may have difficulty making the transition from a highly labor-intensive to a highly capital-intensive production process. Today’s U.S. firms face an increasing threat posed by potential acquisitions and mergers. In addition, the number of plant closings has grown in recent years.

<sup>11</sup>JF Belaud, “Textiles: EEC Policies and international Competition,” *European News Agency*, 1985, p. 37.

<sup>12</sup>The next several paragraphs are based largely on Ruth Ruttenberg, “Compliance With the OSHA Cotton Dust Rule The Role of Productivity Improving Technology,” contract report for the Office of Technology Assessment, March 1983, pp 92-97.

<sup>10</sup>DR Buchanan, *Direction of Technology Change in the Fiber, Textile, and Apparel Industries* (Raleigh, NC: North Carolina State University, 1974).



Table 2.—New Capital Expenditures and Productivity

Period	New capital expenditures				Productivity Indexes (1977 = 100)		
	Manufacturing industries	Nondurable goods (millions of dollars)	Textile mill products	Chemical & allied products	Total manufacturing	Textile mill products	Apparel products
1974	52,480	25,710	1,060	6,180			
1975	53,660	28,280	860	7,120	92.9	72.6	96.0
1976	58,530	31,030	980	7,370	97.1	82.1	95.8
1977	67,480	34,710	1,180	7,350	100.1	100.0	100.0
1978	78,580	39,130	1,310	7,760	101.5	99.4	103.7
1979	95,920	47,420	1,420	9,810	101.4	104.9	106.9
1980	112,330	56,960	1,540	11,630	101.4	110.2	112.6
1981	126,540	66,730	1,660	13,110	103.6	113.0	114.4
1982	120,680	65,330	1,460	12,660	105.9	122.8	117.9
1983	116,200	63,120	1,550	12,960	112.9	129.5	118.0
1984: . . . . .	138,820	72,580	1,920	15,320	118.5	129.5	121.4
1st . . . . .	129,910	68,680	1,870	14,950			
2nd Q	135,960	71,930	1,990	14,850			
3rd Q	142,440	74,180	2,020	15,360			
4th Q	146,960	75,530	1,810	16,120			
1985:	153,150	80,010	1,780	16,450	121.8	129.1	121.0
1st Q	145,650	75,780	2,010	16,430			
2nd Q	154,330	80,360	1,860	16,900			
3rd Q	154,040	81,190	1,740	16,280			
4th Q	158,570	82,700	1,500	16,190			
1986: <sup>a</sup>	149,170	77,090	1,700	17,160			
1st Q	143,060	75,320	1,520	16,020			
2nd Q	148,010	75,800	1,770	16,820			
3rd Q . . . . .	148,470	77,040	1,770	17,270			
4th Q	157,160	80,190	1,760	18,520			

<sup>a</sup>Estimates based on planned expenditures reported by business in late April and May 1986. Quarterly data are seasonally adjusted annual rates.

SOURCE American Textile Manufacturers Institute (ATMI) collected from U.S. Department of Commerce Bureau of Economic Analysis Index for Manufacturing, U.S. Department of Labor Bureau of Labor Statistics Index for others (ATMI Real GNP per payroll hour). Growth Rates ATMI (least squares of natural logarithms of indexes), Washington DC 1986.

The means of modernization vary widely, and are the product of a broad range of new technologies. Older, slower cards, for example, are being replaced by high-speed cards. Chute-feed systems eliminate doffing, racking, manual transport to the card room, and hanging the lap. Open-end spinning eliminates drawing and roving. Conventional shuttle looms are being replaced by high-speed shuttleless looms, some of them 10 times more productive than the equipment they replace. Slower manual cleaning of equipment is being replaced by faster automated cleaning equipment. The production process is becoming more efficient.

Energy savings have also been a benefit of new textile machinery. From 1972 to 1980 alone, the textile industry improved its per unit energy efficiency by over 17 percent through the use of known technology and energy management programs.<sup>13</sup> The air-

<sup>13</sup>American Textile Machinery Association, "Assessment of Energy Conservation Potential at ATME-1 80 Textile Machinery Show in Greenville, SC, Phase I," report for the U.S. Department of Energy, December 1980, p. 7.

jet loom is especially energy efficient. Reduced air consumption can be achieved by a new heat and water recovery process. And in addition to saving energy and water, there is also a reduction in the quantity of polluted effluent—thus assisting companies with their EPA compliance efforts. Sizing equipment, weaving machines, and new carding technology also improve energy efficiency.

Another productivity improvement has been the reduction in needed floor space, as the production process has been consolidated and some steps have been eliminated. In addition, some new machines are more compact. Such space saving translates into reduced costs when building new facilities, as well as less costly expansion in older mills. The chute-feeding system saves floor space by eliminating both the picker floor area and the lap storage and lap conveyor systems. The Platt-Saco-Lowell sizing system is designed to use less floor space. Sulzer claims that the compact design of its PS weaving machine, particularly with the warp beam as far inside the ma-

Figure 10.— New Capital Expenditures and Productivity

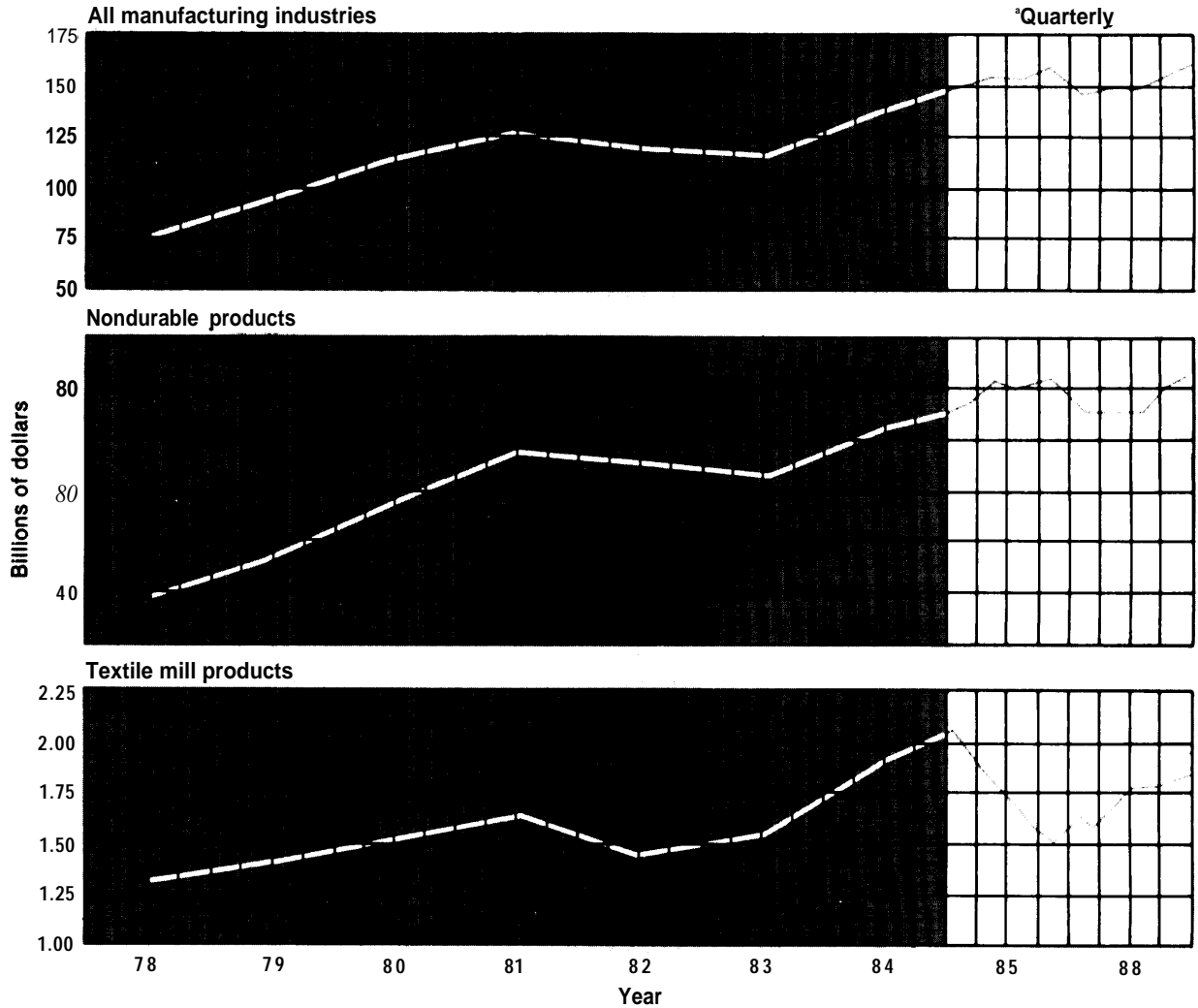

\*Seasonally adjusted.

SOURCE American Textile Manufacturers Institute, collected from U.S. Department of Commerce, Bureau of Economic Analysis, Index for Manufacturing, U S Department of Labor, Bureau of Labor Statistics, Washington, DC, 1986

chine as possible, not only saves space but reduces vibration as well.

Productivity in the textile industry is the dominant factor in competition among U.S. producers; however, this may not be the case for global competition, since exchange rates, labor costs, and non-economic barriers are so significant. Domestically, even small productivity advantages can mean a competitive edge, because most of the industry competes on a cost basis. Productivity advantages over competitors can only be achieved through constant up-

grading of machinery, and capital cycles are short; for example, 5 years for spinning machinery. As a result, only the financially strong will be able to upgrade their production technologies without assistance. But excellent productivity does not always result in excellent financial operating results.

**Improvements in Product Quality**

New textile machinery has the potential to increase production speeds while also improving product quality. In most cases, yarns are stronger, cleaner,

and more uniform. Cloth is of higher overall quality. New looms are faster and can produce wider cloth, giving the manufacturer improved options on sales, further processing, and the increased amount of fabric produced at one time.

Quality improvements begin with new equipment for opening and picking. Because of carousels and automatic feeders, picking can be from a larger number of bales, thus achieving a better blend of cotton. The Bale-O-Matic of the U.S.-owned Automatic Handling Co. claims improved yarn quality due to "consistent hopper feedings [and] controlled cotton mix."

New carding technology also adds to quality. Settings on new and rebuilt cards can be improved, and roller bearings on cylinder supports allow closer settings. Also, because the clothing is more even and metallic clothing allows tighter settings, one can achieve a better integration of fibers. This produces a more uniform and stronger piece of yarn. There are also fewer broken threads. The U.S. Department of Commerce, in studying the chute-feeding system, found that quality improvements came from eliminating thick lap joints and also from less reliance on judgment and more on automation.<sup>14</sup> Martha Mills in Thomaston, Georgia, claims that its chute system—"Levelfeed, CMC"—improves yarn quality by contributing to reduced weight variation.<sup>15</sup>

New spinning technology improves yarn quality. New self-cleaning mechanisms in open-end spinning keep small rollers from becoming dirty quickly, which increases yarn quality. Springs Industries claims that "modernization of yarn manufacturing machinery resulted in better quality yarn . . . and a higher percentage of first quality cloth."<sup>16</sup> An Italian fiber manufacturer that uses robots in its spinning systems claims increased yarn quality due to less handling.<sup>17</sup>

New weaving technology also improves product quality. In 1982, *Textile Industries* published an anal-

ysis of shuttleless looms, with findings of substantial quality improvements over conventional shuttle looms:

A comparison of quality with similar fabrics woven on fly-shuttle looms shows shuttleless weaving to be superior in all categories. Improved quality results in dramatic increase in first-quality, woven cut lengths, generally providing lengths which are more than double those obtained from fly-shuttle weaving.<sup>18</sup>

Draper's air-jet conversion loom claims higher quality cloth, due to a mechanism that removes bad picks and thus minimizes the defects in the cloth. Dornier's rapier weaving machine, as well as other shuttleless weaving systems, has special motions to ensure perfectly woven closed selvages. This machine also has reverse motion capability, which allows it to repair broken picks at any phase without starting marks. Sulzer boasts of the high-quality selvages of its PS and PU weaving machines. Because of repair of broken threads, the proportion of first-quality cloth is increased; uniform weft tension adds to quality as well.

### **Consistency, Standardization, and Quality**

#### **The Production System**

The network that converts fiber into a retail product involves a number of independent enterprises tied together by contract. The consumer sees only the price and the quality of the final product, factors that depend on the combined performance of the entire system. While the performance of each enterprise within this network is clearly important, the efficiency of how the pieces work together is also critical. Recent evidence suggests that the performance of the fiber-to-end use system is far from optimal, in part because of poor communication between fiber, textile, apparel, and retail enterprises.

Better information flows can improve the integrated performance of the system in three ways:

1. they can ensure that cost-reducing techniques used at one stage of production—such as those that produce fiber or yarns of uneven quality—do not block the use of cost-reducing techniques later in the production chain—such as the use

<sup>14</sup>U.S. Department of Commerce, "Opportunities and Strategies for U.S. Textile Machinery Manufacturers To Improve Their Competitive Positions in Domestic and Foreign Textile Markets, 1980- 1985," September 1980, p. II-57,

<sup>15</sup>"Chutes: An Integral Part of a Totally New Program," *Textile World*, September 1981, p. 81

<sup>16</sup>Springs Industries, Annual Report, 1981.

<sup>17</sup>"Italian Robot Proves Its Cost Advantage in Doffing, Donning Heavy POY Bobbins," *Textile Week*, May 3, 1982, p. 5,

<sup>18</sup>Leon Seidel "Projectile Weaving Machines: A Post-Transitional View," *Textile Industries*, May 1982, p 59

- of high efficiency looms that require quality and consistency in fibers;
2. agreed standards and communication protocols can help eliminate redundant counting and sorting of deliveries, and can simplify paperwork for billing, invoicing, and inventory control; and
  3. improved communication links, coupled with new batch production strategies, can allow retailers to keep a wide range of styles and sizes in stock, while reducing inventories throughout the textile and apparel network.

### Quality Standards

In addition to inherent limits that exist in the operating speed of equipment, rapid production throughout the fiber-to-end use chain is limited by defects and poor quality in the materials used. Maximum speeds are limited by the weakest part of the chain—typically the quality of fiber or yarn. As suggested above, the challenge for the industry is to optimize the manner in which the system works as an integrated whole. Costs may be reduced by increasing the speed of winding machines, for example, but the resulting increase in the number of broken ends limits the productivity of equipment that converts the yarn into fabric.

Contrastingly, the high capital costs required to produce clean, high-quality, long-staple cotton fiber may reduce net costs by allowing greater productivity throughout the system. Fiber cleaning may be more efficient; intermediate steps in yarn production may be reduced; fewer broken ends in yarns may improve the efficiency of such follow-on steps as weaving and knitting; and better yarn may result in fewer end-breaks and less machinery downtime.

The key to improving the net performance of the system is to ensure that information about material requirements passes rapidly and accurately between the contributing industries. The lack of materials standards presents special problems. The characteristics required of yarn used in knitting differ from those required of yarn used in weaving; weaving itself can require a variety of yarn types. It seems certain that significant improvements in system-wide productivity can be made simply by improving the language with which these different needs are communicated throughout the system.

## **Coordination and “Quick Response”**

### **New Technologies**

Growing uncertainty about the nature of future markets, and competition from foreign producers, have placed increased pressure on the domestic apparel industry to find ways of reducing costs. Effective management techniques, however, combined with new communication and information processing technology and new production technology, can give domestic producers a significant advantage in many market areas now dominated by foreign production. While foreign producers will always be able to capture certain niches, such as silk blouses or other products requiring an extremely large amount of hand labor, the family of “Quick Response” technologies described below could make domestic production profitable in a wide range of seasonal products.

The key to Quick Response is holding inventories low and avoiding overstocking, while still ensuring that retailers stock what customers want to buy. Accomplishing this will require revolutionary changes in how information flows between the different components of the fiber-textile-apparel-retail chain, and an associated revolution in the style of production. In many ways, the institutional difficulties that must be confronted in implementing such a system pose a greater barrier than the technical problems involved. A basic change in the structure of industry suppliers will be required:

The reorganization of the system that will result from the adoption of Quick Response systems will therefore lead to further consolidation of the textile and apparel industries as retailers and apparel manufacturers will both seek to develop stronger relationships with a smaller number of suppliers, each offering the capability to produce a wider range of products than is usually the case today.<sup>19</sup>

Kurt Salmon Associates points to a similar trend in the automobile industry, where the Big Three automakers are reducing the number of their suppliers, and are selecting their suppliers based on quality, service, flexibility, technological expertise, and product development skills as much as on price.

<sup>19</sup>Peter W. Harding, Manager of Textile Industry Services, Kurt Salmon Associates Inc., “Quick Response in the Soft Goods Pipeline,” synopsis of speech to the Knitted Textile Association Retail Relations Workshop, Dec 6, 1985, p. 12

There are major “hard” and “soft” technological requirements of Quick Response, for textile mill manufacturers, apparel manufacturers, and retailers (see figure 11):

For textile mill manufacturers, hard technology includes flexible for shortrun weaving, shortrun dyeing and finishing, computerized defect mapping with shading information, computerized fabric design, and faster samples. Soft technology includes putups for faster handling by cutter, rolls pre-sorted by width, shipping information by computer, and sequential truck loading.

For apparel manufacturers, hard technology includes computer assisted design, automatic marking and cutting, flexible sewing with microprocessor, robotic handling, and unit production systems. Soft technology includes shop floor controls, logistics, supplier-cutter linkage, retailer-cutter linkage with merchandise control, and implementation.

For retailers, hard technology includes electronic data interchange from point-of-sale to vendor, point-

of-sale data capture with bar coding, and sortation systems in distribution center. Soft technology includes merchandise planning and control systems, automatic markdown information, pre-marking by vendors, and pre-distribution by vendor.<sup>20</sup>

Efficient transportation also plays a key role. Textile suppliers are now able to communicate with large apparel companies with such precision that apparel firms have reliable information about the time and size of delivery, as well as the color and location of fabric within a truck. This permits apparel producers to closely integrate deliveries into their plans, and allows them to avoid costly and lengthy inventories of materials delivered. The Levi Co. estimates that their new communication system, by itself, saves as much as 10 cents per square yard of material.

<sup>20</sup>Peter N. Butenhoff and R.E. Cotton, Du Pent, “U.S. Apparel Competitiveness,” May 28, 1986.

Figure 11.—The Apparel Pipeline at a Glance: Present System v. Quick-Response Strategies

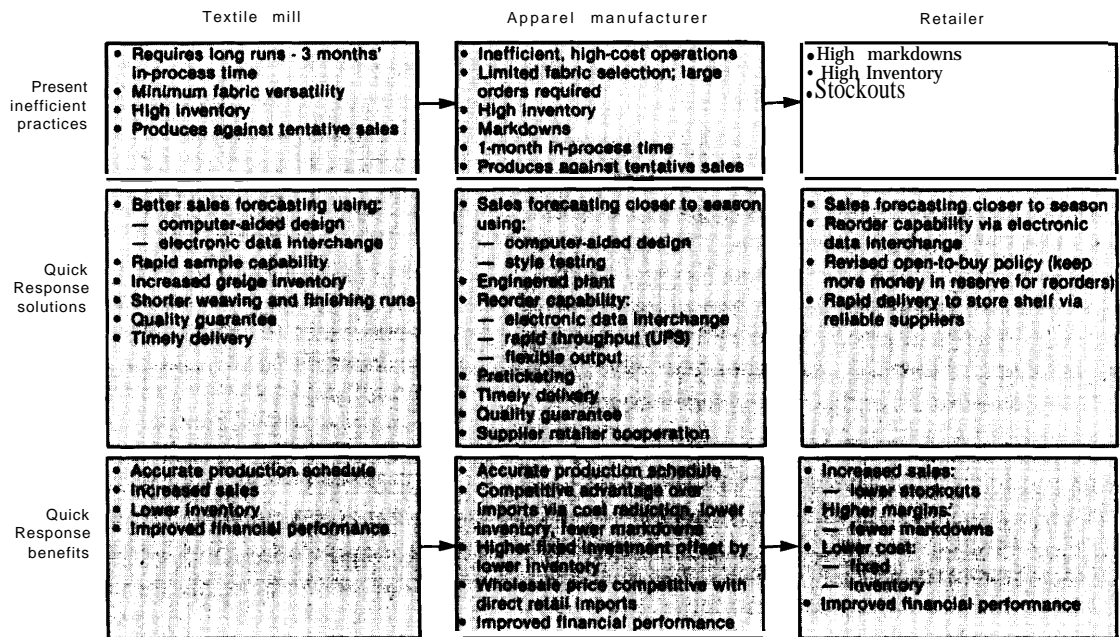

Quick Response potential (savings. in \$billions)	Textile mill	Apparel manufacturer	Retailer	Total system savings
Forced Markdowns	0.3	2.0	5.0	7.3
Stockouts	—	0.2	1.7	1.9
Inventory	0.5	1.3	1.5	3.3
Total	0.8	3.5	8.2	12.5

SOURCE: Peter N. Butenhoff, “U.S. Apparel Competitiveness,” paper presented to OTA by El. du Pent de Nemours, & Co., June 1988.



Photo credit Copyright ( ) 1986, 1987 by Bobbin International, Inc. All rights reserved

The Philadelphia College of Textiles and Science has a computer-assisted design (CAD) laboratory equipped with 10 design stations. Above, a student works on a fashion illustration.

Efficient transportation networks are also required between apparel producers and retail outlets. As one observer puts it:

[If you can process a style in four hours, but it then waits three days for the next truck to your distribution center, and then it takes another couple of weeks to go through your distribution center to get on to the retail shelf for presentation to the customer, you cannot capitalize on the potential for quick response.<sup>21</sup>

It can take up to 2 months for a product to get from an apparel plant to the sales floor. The initial experiments with Quick Response have shortened this time span considerably, using United Parcel Service for rapid deliveries.

A Quick Response pilot program, organized by the Crafted with Pride in U.S.A. Council, Inc.; Wal-Mart Stores of Bentonville, Arkansas; Seminole Manufacturing Co. of Columbus, Mississippi; and Milliken & Company of Spartanburg, South Carolina, has shown substantial success.<sup>22</sup> Basic improvements, which were clear after only 3 months, include:

- increasing the frequency of replenishment orders from monthly to biweekly, thus enabling stock-

<sup>21</sup>Robert M Frazier, "Quick Response," presentation made at DUPAATCH, Sept 13, 1985

<sup>22</sup>Kurt Salmon Associates, Inc., "Crafted With Pride in U.S.A. Council, Inc., Quick Response Program Report," June 11, 1986.

- outs to be avoided or detected earlier and reducing the size of reorder shipments;
- cutting reorder cycle time, from counting inventory on the selling floor to receipt of the replenishment order, by 33 percent;
- shortening the cut authorization-to-finished goods availability by 30 percent through changing from monthly to weekly planning; and
- reducing the color assortment-to-shipment time by 50 percent.

### Quick Response and U.S. Competitiveness

Figure 12 indicates the large gap that now exists between the wholesale price of garments imported from the Far East and garments available from domestic producers; the size of the gap depends on the type of fabric used and the percent of the wholesale cost due to labor. Overseas producers have a comparative advantage in products using relatively labor-intensive fabric, or "topweights," because foreign topweight fabrics may cost 35 percent less than equivalent domestic fabrics, while fabric costs may only be 15 percent lower for the less labor-intensive, "bottomweight" fabrics. Most U.S. apparel producers, however, clearly must find a way to shave between 10 and 35 percent off their costs in order to compete directly with many foreign suppliers.

Figure 12.—Retailers' Sourcing Cost Comparison: United States v. Far East

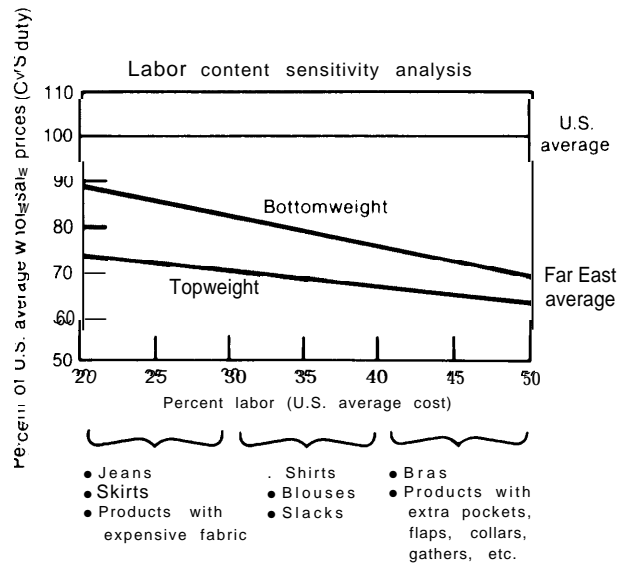

SOURCE: Peter N Butenhoff, "Quick Response Technology —Needs and Justification," E I du Pont de Nemours & Co, January 1987



Photo credit: Copyright (©) 1986, 1987 by Bobbin International, Inc.  
All rights reserved

Computers used to track the flow of finished goods into the warehouse can help to improve communication between apparel manufacturers and retailers. In addition to reducing overhead costs, computer-based monitoring can facilitate inventory control, and thus can increase the efficiency of the system that brings a product to the consumer.

Quick Response systems can close this cost gap in several ways. First, the enormous inventories carried by textile mills, apparel manufacturers, and retailers can be reduced. On average, it takes roughly 65 weeks for fiber to move from a manufacturing plant to the customer's hand. The material is in processing for only 15 out of these 65 weeks; the remaining 50 weeks are spent sitting in inventory.<sup>23</sup> The cost of this inventory alone represents 6.4 percent of retail sales. With good management, it should be possible to reduce this by 25 to 50 percent.<sup>24</sup> Proper

<sup>23</sup>Sig Scheier "QR to Consumer Demand Vital, Hinerfeld Warns," *Daily News Record*, Oct. 9, 1985, p. 11.

<sup>24</sup>Frazier, *op. cit.*

inventory control can increase sales per square foot, ensuring that the assortment on the selling floor matches proven market demand for styles, colors, and sizes.

Second, it should be possible to reduce incidence of forced markdowns that result from orders of goods that fail to sell as expected. Forced markdowns have grown by 50 percent during the past decade, and the National Mass Retail Institute estimates that total losses may be as high as 15 percent of retail sales.<sup>25</sup> Forecasting failures are due in large part to the long planning cycle that is now typical in the industry—most initial orders for seasonal products must be placed more than a year before the products are sold. With Quick Response, it may be possible to reduce initial order times to 2 or 3 months, and reorder cycle times to a few weeks. Accordingly, the need for long range, imprecise forecasting is greatly reduced:

If the manufacturing cycle can be reduced through the use of more flexible manufacturing technology, then the time horizons for forecasting may also be reduced with resulting improvements in accuracy. Better collection of data from point of sale terminals, better systems to analyze this data and electronic communications will ensure that better and more timely information will be available on which to base forecasts. This will also encourage the use of better forecasting tools, which are often not used today because the quality and quantity of data available does not justify their use.

Computers and electronic data interchange provide us with the tools we need to both process and to communicate the information that our partners in the system require.<sup>26</sup>

The third area where Quick Response can result in cost savings involves "stock outs," or situations where business is lost because a customer cannot find apparel in the desired style or size because it is out of stock. Quick Response systems permit smaller initial orders, allowing stores to reorder more of a product that proves to be popular. The product can then be in stock at full price during the selling season.

Estimating the magnitude of "stock out" losses is a difficult task, since many consumers who don't find what they want simply leave a retail store without

<sup>25</sup>*Ibid.*

<sup>26</sup>Harding, *op. Cit.*, pp 11-12.

registering their disappointment. Industry estimates suggest that losses from stockouts are about 8 percent of apparel sales.<sup>27</sup> Field experiments with Quick Response systems suggest that this may be an underestimate. The Wal-Mart experiment, cited earlier, found that using Quick Response reordering systems for sales of basic men's slacks increased inventory turnover at the astonishing rate of 30 percent, with a comparable increase on gross margins on inventory.<sup>28</sup> A stock count indicated that while 29 percent of items checked were out of stock before the program, only 17 percent were out of stock after the Quick Response system was initiated. Retail stores can offer a greater variety of products without a significant increase in inventory through the ability to replenish stocks quickly. Overall, the Wal-Mart experiment claims to have yielded year-to-date sales increases of 47 percent, and 31 percent on a same store basis.<sup>29</sup>

Quick Response systems can also reduce costs and paperwork associated with such overhead operations as billing, invoicing, and inventory controls. Improved information flows and standardized reporting systems can greatly reduce handling and processing costs, like quality control audits, hanging and premarking of merchandise, and time spent handling and counting deliveries. Perhaps most importantly, four networks that link different parts of the fiber-to-finished product chain more effectively have been created within the last year:

- **The Fabric and Supplier Linkage Council (FASLINC):** Having commenced operations only in January of 1987, FASLINC is designed to improve and facilitate communication between fabric producers and their suppliers.
- **The Textile and Apparel Linkage Council (TALC):** Begun in the spring of 1986, TALC works between textile mill firms and apparel manufacturers.
- **The Sundries and Apparel Findings Council (SAFLINC):** This network, established in March of 1987, ties apparel manufacturers with a diverse group of suppliers, ranging from button makers and lacers to packagers and labelers.

- **The Voluntary Interindustry Communications Standards (WCS):** This final link in the chain connects the apparel manufacturer with the retailer.

Increased communication and standardization between different sectors within the textile and apparel industry complex will quicken the process by which the final product is brought to the consumer, leading to further reductions in overhead costs and bringing production even closer to the marketplace.

Finally, productivity gains can be realized within the apparel production facility through the use of off-the-shelf equipment, and better management practices can facilitate integration with the overall Quick Response system. Many of these techniques have been discussed in earlier sections of this report. Moving away from the "progressive bundle" system—a process driven by repetition of standardized tasks, which may have been cost-effective in an environment where response time and inventory control was not critical—to a modern unit production system can reduce processing times of 4 to 6 weeks to 1 or 2 days.<sup>30</sup> Computer-controlled cutting techniques can reduce material losses by 2 to 3 percent and can take 1 to 2 weeks out of planning, while reducing the number of parts that are cut simultaneously by 30 to 50 percent.<sup>31</sup> Taken together, these innovations could reduce average apparel assembly costs by at least 7 percent; the new generation of (TC)<sup>2</sup> technologies could, of course, lead to even greater time savings.

A conservative estimate of the savings that can be realized from a relatively straightforward implementation of Quick Response technologies indicates that the industry could have saved \$12.5 billion in 1984 (again see figure 11). These savings are realized by the entire system acting as a whole, and may not be recognizable in a study that focuses on only a single part of the system. Indeed, the use of small batches can actually increase the cost of material, while the most efficient "progressive bundle" apparel assembly system may cost 7 percent less than the most efficient Quick Response system. Also, small batch shipping requirements may increase freight

<sup>27</sup>Frazier, op. cit.

<sup>28</sup>"Quick Response Pilot Program Update," *Crafted With Pride*, January 1987.

<sup>29</sup>Ibid.

<sup>30</sup>R. E. Cotton, "QR's Bottom Line," *Apparel Industry Magazine*, June 1986, pp 23-31.

<sup>31</sup>Frazier, op. cit.





Photo credits: Copyright (©) 1986, 1987 by Bobbin International, Inc.  
All rights reserved

The Gerbermover GM-100 "unit production" system (above), installed in Mary Fashions in late 1986, reduces manufacturing time significantly from the "progressive bundle" system (bottom). Note that in unit production, the fabric moves between sewing stations by automation rather than by hand. In the progressive bundle system, hand transfer means time spent not only in the actual movement of fabric, but in tying and untying bundles and pressing wrinkles out of folded pieces.

charges. Such cost penalties, however, appear to be more than offset by the system-wide gains that Quick Response will bring.

Quick Response systems could reduce overall costs to the point where purchases from domestic suppliers will be competitive with imports. Figure 13 indicates

Figure 13.—Breakdown of Original Retail Price  
(Mass Merchant . Private Label Seasonal Product)

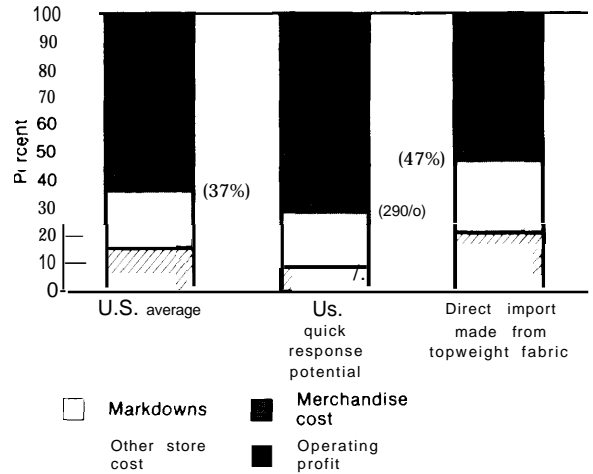

SOURCE: E.I. du Pont de Nemours & Co., "Quick Response Technology," paper presented at North Carolina State University, January 1987

the breakdown of costs for retail sale of a "private label" seasonal product made from topweight fabric; conservative assumptions about the gains from "stock outs" are used. The figure includes the cost savings that are potentially achievable from Quick Response systems, as well as the "hidden costs" of imports—increased communication and travel expenses, and inefficiencies due to uncertainties and delays. Accordingly, retailer profit margins using Quick Response can be as high as those achievable from sales imports. Competition with foreign suppliers, of course, still depends on the 10 to 30 percent advantage realized from tariffs paid by importers, and on higher shipping costs.

One obvious question brought by the implementation of Quick Response is whether other exporting nations can participate in such a system. Benetton, the Italian apparel manufacturer and retailer, has established a production facility in North Carolina, as part of an overall strategy to move closer to U.S. demand; Benetton's flexible production capacity has already allowed this firm to successfully target U.S. market niches. The more sophisticated Asia producers, like those in Korea, Taiwan, and Hong Kong, could certainly enter into a Quick Response network by using air freight for delivery, although the additional costs of the freight could reduce the range of products in which they are competitive.

On the other hand, because they have reached their quota limits, these nations do not represent a majority of U.S. imports. Many of the nations that have increased exports to the United States in the past few years will face great difficulties in building the communication and transportation infrastructure needed to participate in a Quick Response network.

Quick Response, by attempting to change some of the dynamics of competition between domestic and imported goods, and by fostering cooperation between U.S. manufacturers and retailers, is clearly a critical part of efforts to increase domestic production. Because the United States probably has enough retail square footage to serve almost twice as many consumers as are now in its market, and because there is much sameness in merchandise and service, price has been considered the best way to attract and keep a customer. But according to Kurt Salmon Associates, Inc., it may be possible to revise this assumption through Quick Response:

The great majority of retailers have accepted it [price] as the only competitive weapon left to them. This induced an acceleration of private label import programs as stores moved to protect their margins and market shares while offering something unique to their customers.

In the process, of course, direct importing by retailers created havoc among domestic apparel makers

and their textile suppliers. Faced with under-utilization of their assets, squeezed margins, and uncertain sales outlooks, manufacturers widened their distribution. Nationally advertised brands and designer labels, tightly controlled only a decade ago, were now available at varying prices in almost every type of retail outlet .

As markdowns increase on both domestic branded merchandise and off-shore private label purchases, the retailer has become increasingly demanding of his resources. The latter fight back by widening their distribution and developing their own sources overseas . . . In the meantime, the consumer is being ignored .

A more integrated and efficient soft goods chain, dedicated to responding to consumer wants quickly, will benefit everyone.<sup>32</sup>

Of course, in order for Quick Response to become a reality, a serious commitment from industry to reorganize production facilities will be needed—a move that many U.S. apparel firms are reluctant to make. As one expert on industry productivity and organization writes, “to move into Quick Response means a willingness to take some risks and to make changes in the way you do business.”<sup>33</sup>

<sup>32</sup>Kurt Salmon Associates, Inc., “Quick Response for Retailing,” *The KSA Perspective*, January 1986, p. 3.

<sup>33</sup>Emanuel Weintraub, “Buzzwords With No Deeds Don’t Make it.” *Bobbin Magazine*, September 1986, p. 50.

## INDUSTRIAL STRUCTURE

### **Background**

Changes in the technology of each step in the fiber-to-end use production chain, and how these steps are integrated by strategies like Quick Response, bear a direct relationship to changes in the business structure of textile and apparel enterprises. Textiles and apparel are, of course, distinct industries, and each faces unique problems.<sup>34</sup> Both are relatively fragmented by modern standards, but textile manufacturers have generally been larger and more capital-intensive than smaller, more labor-intensive apparel firms.

The entire textile and apparel industry includes enterprises in at least 66 four-digit standard indus-

trial classification (SIC) codes. Because of the growing technological diversity of the industry, some textile production may be included in other SIC codes as well (see table 3). In addition, there are several nonmanufacturing sectors totally dependent on textile manufacturing—most notably retail trade for textile products.

The various sectors of the industry complex compete in a variety of markets, ranging from the trade of cotton on exchange markets to the retail distribution of apparel goods. All of these markets have become global in nature. Some, such as textile mill products, are being increasingly integrated. Others, primarily apparel, are still fundamentally a sector of small employers with limited production variety.

Traditionally, the industry has been horizontally structured, with the manufacture of cloth and the

<sup>34</sup>Bruce Stokes, “(;~tt) ngCompetitive’ *National Journal*, June 7, 1986, p. 1362.

Table 3.—SIC Codes for Textiles and Apparel

<b>SIC 22 Textile Mill Products</b>	
1.2211	Broad woven fabric mills, cotton
2.2221	Broad woven fabric mills, man-made fiber & silk
3.2231	Broad woven fabric mills (including dyeing & finishing)
4.2241	Narrow fabrics & other smallwares mills: cotton, wool, silk, and man-made fiber
5.2251	Women's full length & knee length hosiery
6.2252	Hosiery, except women's full length & knee length hosiery
7.2253	Knit outerwear mills
8.2254	Knit underwear mills
9.2257	Circular knit fabric mills
10.2258	Warp knit fabric mills
11.2259	Knitting mills, not elsewhere classified
12.2261	Finishers of broad woven fabrics of cotton
13.2262	Finishers of broad woven fabrics of man-made fiber & silk
14.2269	Finishers of textiles, not elsewhere classified
15.2271	Woven carpets & rugs
16.2272	Tufted carpets & rugs
17.2279	Carpets & rugs, not elsewhere classified
18.2281	Yarn spinning mills: cotton, man-made fibers & silk
19.2282	Yarn texturizing, throwing, twisting & winding mills: cotton, man-made fibers & silk
20.2283	Yarn mills, wool, including carpet & rug yarn
21.2284	Thread mills
22.2291	Felt goods, except woven felts & hats
23.2292	Lace goods
24.2293	Paddings & upholstery filling
25.2294	Processed waste & recovered fibers & flock
26.2295	Coated fabrics, not rubberized
27.2296	Tire cord & fabric
28.2297	Nonwoven fabrics
29.2298	Cordage & twine
30.2299	Textile goods, not elsewhere classified
<b>SIC 23 Apparel &amp; Other Finished Products Made From Fabrics &amp; Similar Materials</b>	
31.2311	Men's, youths', & boys' suits, coats, & overcoats
32.2321	Men's, youths', & boys' shirts (except work shirts) & nightwear
33.2322	Men's, youths', & boys' underwear
34.2323	Men's, youths', & boys' neckwear
35.2327	Men's, youths', & boys' separate trousers
36.2328	Men's, youths', & boys' work clothing
37.2329	Men's, youths', & boys' clothing, not elsewhere classified
38.2331	Women's, misses', & juniors' blouses, waists & shirts
39.2335	Women's, misses', & juniors' dresses
40.2337	Women's, misses', & juniors' suits, skirts, & coats
41.2339	Women's, misses', & juniors' outerwear, not elsewhere classified
42.2341	Women's, misses, children's, & infants' underwear & nightwear
43.2342	Brassieres, girdles, & allied garments
44.2351	Millinery
45.2352	Hats & caps, except millinery
46.2361	Girls', children's, & infants' dresses, blouses, waists, & shirts
47.2363	Girls', children's, & infants' coats & suits
48.2369	Girls', children's, & infants' outerwear, not elsewhere classified
49.2371	Fur goods
50.2381	Dress & work gloves, except knit & all-leather
51.2384	Robes & dressing gowns
52.2385	Raincoats & other waterproof outer garments
53.2386	Leather & sheep lined clothing
54.2387	Apparel belts
55.2389	Apparel & accessories, not elsewhere classified
56.2391	Curtains & draperies
57.2392	Housefurnishings, except curtains & draperies
58.2393	Textile bags
59.2394	Canvas & related products
60.2395	Pleating, decorative & novelty stitching, & tucking for the trade
61.2396	Automotive trimmings, apparel findings, & related products
62.2397	Schiffli machine embroideries
63.2399	Fabricated textile products, not elsewhere classified
<b>Others</b>	
64.2823	Synthetic fibers
65.2824	Organic fibers, noncellulosic
66.3552	Textile machinery

SOURCE U S Executive Office of the President, Office of Management and Budget, *Standard Industrial Classification Manual, 1972*

manufacture of clothing fairly separate. Fiber producers supplied raw material to yarn manufacturing plants, which in turn sold yarn to weaving or knitting facilities. Manufactured fabric was sold or commissioned to a fabric finisher, and then sold to the garment manufacturer. Textile converters and jobbers helped oversee the movement of products from one processor to another, supplying a finished product to cutters or retailers and maintaining product supplies for spot markets. Clearly, a great deal of time is involved with this flow sequence, making creative and rapid response to market needs very difficult. Having many intermediate companies han-

dling the product has made quality control a particular problem, increasing the levels of product waste.

More emphasis on continuous flow and vertical integration, spurred on by growing interest in Quick Response, is changing the industry's structure. While much of the apparel industry is still quite decentralized, especially the contractor portion, there is more integration than disintegration.

In the early 1950s the leaders of the textile industry, particularly Burlington Industries and Milliken, responded to the need for restructuring of material

flow. More vertical and market-oriented organizations were established to handle the textile product from fiber to finishing. Research and development became a part of many of the larger, more diversified companies, where previously it was mostly in the domain of fiber producers. Vertically structured companies seemed better able to respond to some market requirements and to supply versatility in their products. In addition, staff functions such as financial planning, product development, industrial engineering, marketing, and cost accounting could often be more fully supported by vertically structured companies. However, there is controversy in some textile sectors over trade-offs between economies of scale from integration and the loss of flexibility that producers of small lots can provide, especially to fashion-oriented parts of the apparel industry.

Textile companies are restructuring far more than material flows. Mergers and takeovers are abundant. Most of these moves have increased horizontal integration; some have increased vertical integration. Stevens recently bought Burlington's sheet and towel division, and is trying to sell its clothing businesses while enlarging its household and industrial textiles divisions. Springs bought Lowenstein, becoming the second largest U.S. cloth producer. Fieldcrest acquired Cannon. These three actions alone consolidated the sheeting market significantly, with the three firms together holding half of that market. In other moves, West Point-Pepperell, enhancing its vertical integration, has bought Cluett Peabody, a shirtmaker best known for its Arrow brand. United Merchants & Manufacturing Inc. bought Jonathan Logan. Cone Mills, Dan River, Levi Strauss, and Blue Bell have reverted to private ownership to protect themselves against takeover bidders.<sup>35</sup>

At the same time that companies are consolidating, there is movement afoot to expand the importance of small contract shops in apparel. While the number of contractors in the United States has diminished by more than 50 percent in the last 15 years,<sup>36</sup> today's emphasis on proximity to the marketplace, on speed of response to retailers' private label programs with local retail stores, and on direct dealing with retailers that eliminates the "mid-

dleman" manufacturer, may open new opportunities for those contractors who remain. Reliance on contractors, however, could draw resources away from needed investment in other areas, such as technologies that can help apparel manufacturers to adapt directly to changes in consumer preferences—and over the long term, the willingness to innovate may determine whether U.S. apparel firms will be able to compete in world markets.

### **Structural Changes**

In this analysis, "industry structure" refers to the number and sizes of firms in a given industry and the type of competition that exists among them. In the past, the textile industry complex has consisted of a very large number of small- and medium-sized firms, and a high degree of competition. The future industry may be characterized differently. As many firms integrate and as they become part of large and diversified corporate entities, the traditional buyers and sellers and the links among them may change.

Traditionally, the textile and apparel industry structure consisted of an agricultural producer of cotton or wool fiber selling to a fabric manufacturer, who in turn would sell to a producer of apparel; finally, apparel would be sold to retail stores for sale to the consumer. The majority of textile shipments proceeded along this chain. This is no longer the case. Agricultural producers are being replaced by chemical companies who manufacture synthetic fibers. The apparel segment, while still the largest of the end uses, is no longer the largest purchaser of fabric. Home furnishings and industrial uses are, together, larger. In some cases the fabric process represents an end product, as in the tufting of carpets or the weaving of towels and bedding. As a result, new relationships and new alliances become a necessity. The pressure for vertical integration means that traditional links in the chain are more susceptible to either backward or forward integration efforts. While some markets, such as those for cotton blouses, may remain quite similar to their traditional structure, the structure will be new in a growing number of product lines.

With the exception of apparel, the era of a textile industry dominated by small, family-owned and -operated companies is a thing of the past. As the fiber-fabric-apparel-retail set of links has weakened,

<sup>35</sup>"America's Textile Industry Holding Its Salvation in Its Own Hands," *The Economist*, Apr 5, 1986, p. 80

<sup>36</sup>Joyce Santora, "Contractor Move to Bring Production Back," *Bobbin Magazine*, April 1986, p. 52

so too has the industry structure which supported small companies providing limited numbers and types of products for limited geographical markets. Concentration varies from segment to segment, but vertical integration and the growth of multinationals is a reality, especially in fibers and fabrics. With the exception of apparel, where concentration ratios are mostly quite low, the most heavily concentrated segments are also the largest employers. The two segments which represented the largest share of capital expenditures and of gross fixed assets—cotton weaving and manmade fiber weaving—had respective concentration ratios of 42 and 39 percent in 1977, in contrast to ratios of 39 and 31 percent 5 years earlier.

Concentration ratios by market segment measure horizontal integration. Vertical integration, on the other hand, by which one segment acquires capacity in other industry segments, represents another form of concentration. This is usually accomplished by integrating either backwards or forwards to merge production processes that occur in sequence. For example, fabric producers might integrate backwards to acquire a yarn manufacturing firm. Or an apparel segment, such as knitting outerwear, might integrate forward into the retail area. As more and more multinational firms with diversified production capacities enter the market, vertical integration can be expected to increase.

### **Trends in Investment and Disinvestment**

Many observers bemoan the plant closings and disinvestment that are occurring throughout the textile industry. Between 1977 and 1982 alone, the number of textile plants and firms declined 10 percent.<sup>37</sup> From 1983 through mid-1985, nearly 1 million spindles and 15,500 looms were eliminated. The geographic impact of these disinvestments was dramatic—more than 85 percent of the spindles were eliminated in the three States of South Carolina, North Carolina, and Georgia. More than 95 percent of all looms were shut down in these States; 63 percent of the impact was in South Carolina alone (see

<sup>37</sup>Centaur Associates, Inc., "Technical and Economic Analysis of Regulating occupational Exposure to Cotton Dust," vol. I, prepared for the occupational Safety and Health Administration (OSHA), January 1983, p. 1-2

**Table 4.—Permanent Plant Closings in the U.S. Textile Industry, 1983-June 1985**

Location	Number of spindles eliminated	Number of looms shut down
Georgia . . . . .	175,012	2,602
North Carolina . . . . .	266,956	2,188
South Carolina . . . . .	390,564	9,750
Alabama . . . . .	56,816	—
Virginia . . . . .	77,060	499
Connecticut . . . . .	2,100	—
Texas . . . . .	—	—
California . . . . .	5,280	—
Massachusetts . . . . .	3,120	—
Total . . . . .	976,908	15,489

SOURCE\* American Textile Manufacturers Institute, Washington, DC, 1986

table 4). A February 1985 survey by the American Textile Manufacturers Institute of its own membership estimated that 44 plants had closed in 1981, 100 in 1982, 49 in 1983, and 38 in 1984. The impact on individuals who lose their jobs and the communities that lose a critical economic base has been severe, especially since so many of the affected plants have been in small communities with few other employers.

Nonetheless, disinvestment has not been the only trend. Substantial new investments have been made by many companies, and even by some of the very companies that are also disinvesting. Stevens Corp., for example, in the early 1980s made plans to close three or four plants, in addition to four closings or phase-outs that had already been announced.<sup>38</sup> But at the same time, Stevens was planning for \$500 million in new plant and machinery investments over the next several years, including 450 new air-jet looms.<sup>39</sup> Dan River, while committed to an aggressive modernization-through-investment program, sold off a plant in Simpsonville, South Carolina, and closed its texturing operation in Mebane, North Carolina. Burlington closed its Madison, North Carolina, yarn plant during 1986, but is spending several million dollars through 1987 to improve technology at its Twintex and Mayodan texturing plants.<sup>40</sup>

Basic elements of supply and demand for textiles have changed in the last decade, and promise to change still more in the decades ahead. The market for textiles is increasingly a global market, demand-

<sup>38</sup>"Textile Week Hears . . ." *Textile Week*, June 22, 1981

<sup>39</sup>Ruttenberg, *op. cit.*, p. 89.

<sup>40</sup>*Daily News Record*, June 5, 1986, p. 8.

ing specialization and identification of competitive market niches. An industry of many small firms is giving way to oligopolistic markets, or at least to monopolistic competition. A large number of firms engaging in price competition with similar if not identical markets is a fading economic possibility for the U.S.-based industry. Fewer corporate entities are supplying textile products for sale. More and more corporate entities within the fiber-fabric-apparel-end use-retail chain are “selling” products to themselves, or transferring products from one division or subsidiary of the company to another to eliminate price competition altogether. The products being demanded are thus often purchased by internal corporate entities. And the products being demanded are more often for end uses other than apparel, such as home furnishings or industrial purposes.

Not only must the industry adapt to changes in basic supply and demand. It must meet intense challenges to traditional ways of making decisions about trade, research and development, capital investment, employment, and marketing.

### ***Into the Future***

The textile industry of the 21st century will be more capital-intensive, more horizontally and vertically integrated, and more internationally linked than ever before. Within the United States, there will be both plant closings and company expansions; markets will increasingly be more carefully identi-

fied and targeted; production will be geared to identified market niches. Synthetic rather than natural fibers will represent growth in fiber markets. Non-woven rather than woven fabrics will represent growth in textile markets. Industrial and home furnishings, as well as apparel, will have some promising product areas in which to identify market niches for end uses. The traditional segmentation of markets—into individual production processes, separate geographic regions, and/or single technologies—will not be the predominant organizing feature of most industry sectors. Instead, there is likely to be increased horizontal and vertical integration, greater participation by chemical and paper producers and by multinational corporations, more capital intensity, and a continuing shift to a global market.

The major exception is likely to be apparel, but this sector could integrate by way of major technological breakthroughs. It is more likely, however, at least in the short to medium term, that apparel will continue to be an industry structure of small firms. Of the more than 200 apparel companies in the United States, less than 1 percent have sales over \$100 million per year.<sup>41</sup> Without stricter enforcement of wage and hour regulations, there may be further growth in “underground assembly,” through employment of illegal aliens at subminimum wages. The critical problem to overcome is the current high level of import penetration.

<sup>41</sup>Wilson, *op cit*, p.9

---

**Chapter 3**

**The Major Industry Sectors:  
Fiber, Fabric, Finished Products,  
and Machinery Manufacturing**

# The Major Industry Sectors: Fiber, Fabric, Finished Products, and Machinery Manufacturing

---

The previous chapter outlined broad themes affecting the industry complex that converts fiber into apparel and other end uses. This chapter will examine the major segments of the industry in greater detail, addressing changes in both production technology and patterns of business organization. The industry will be subdivided as follows:

1. **Fiber Production:** The process of manufacturing fiber varies greatly, depending primarily on whether the fiber is made of natural or synthetic materials. Synthetic fiber production is closely allied with the capital- and research-intensive chemical industry; the standard industrial classifications (SIC) for synthetic fiber manufacturing are part of the chemical and allied products series, and are not grouped with textile mill products,
2. **Textile Mill Products:** Fabric production is still primarily accomplished with weaving, though knitting and tufting are examples of nonwoven fabrics. The industry is being revolutionized by the shift from shuttle to shuttleless looms, a

technology that has been developed primarily by foreign producers.

3. **Apparel (and other end uses):** Manufactured finished products made from textiles are dominated by apparel. In recent years, however, the largest growth in finished products has been in home furnishings and industrial applications. Textiles are being used for a variety of industrial purposes, going far beyond the traditional uses in automobiles. Textiles are now used in high technology medicine, space exploration, erosion control, and highway building. The industries that make finished products are diverse, and include many small firms.
4. **Textile Machinery Manufacturing:** In previous generations, the textile machinery manufacturing sector was the “mover and shaker” behind productivity growth throughout the industry. In recent years, however, few major technologies have been introduced by U.S. firms.

## THE PRODUCTION OF FIBER

The fiber sector of the textile industry complex has undergone substantial change in recent years. Synthetic fibers have supplanted natural fibers at a rapid rate. Representing less than 10 percent of the market in 1940, synthetics captured nearly 75 percent by the mid-1980s. Cotton, which made up over 80 percent of U.S. mill fiber consumption in 1940, fell to just over 25 percent by the mid-1980s.<sup>1</sup> While rayon and acetate represented the only two man-made fibers 50 years ago, today there are thousands of individual products in 10 major classes that can

be processed into an almost infinite variety of fabric constructs and styles.<sup>2</sup>

Besides the obvious adjustments in the fabric and apparel industries, the entire structure of the fiber industry has been altered. As synthetics have come to dominate the market, so too have the large multinational chemical companies that are among the major producers of synthetic fiber. With new processes has come a new level of technology and capital intensity as well.

<sup>1</sup>American Textile Manufacturers Institute, *Textile Highlights*, September 1986, p. 1

<sup>2</sup>Richard E. Emmert, “The Long View,” presented at the 50th Annual Research and Technology Conference, Textile Research Institute, Washington DC, Apr. 3, 1980, p. 1



## Background

The fiber industry is composed of the agricultural sector, which supports the production of natural fibers—primarily cotton, but also wool, silk, linen, and jute—and the chemical industry sector, which produces manmade fibers. Most fibers are highly substitutable; not only do manmade fibers compete among each other, but they can substitute for natural fibers.

In 1980, approximately 17 percent of all fibers produced in the world were consumed in the United States; this share fell from close to 20 percent in 1960. Experts believe that the share will continue to fall, reaching 16 percent by 1990. The two major factors responsible for the decline are a marked slow-down in U.S. population growth, along with the substantial industrial progress demonstrated by developing countries.

On the other hand, per-capita fiber consumption is much higher in the United States than in other countries of the world, with a level of 58 pounds per person versus an average world consumption in 1983 of 15.5 pounds per person. But U.S. consumption may have peaked, falling to under 56 pounds per person by 1985;<sup>3</sup> at the same time, world consumption grew sharply. World growth in fiber consumption is a critical factor for U.S. firms to consider as they develop marketing strategies. Of the total growth in world fiber consumption, two-thirds is due to increases in per-capita consumption and one-third from population increase.

Cotton represented a much higher market share of 1983 world fiber production, 48 percent, than of 1983 U.S. fiber production, 25 percent. And yet world production of manmade fibers has shown a growth parallel to U.S. production since the 1940s, and is only today growing faster than U.S. production. The United States is currently the leading world producer of manmade fibers. China is the largest producer of cotton, with the United States being second. Australia is the world's leading wool producer; wool production in the United States is insignificant in the world market, at 1.5 percent of total production.

## Natural Fibers

The major market for natural fibers in the United States is for cotton. It is by far the dominant sector among natural fibers, with over 90 percent of natural fiber consumption and 25 percent of the overall fiber market. Wool and silk are negligible in their overall importance.

Cotton.—Besides the dominant trends of non-growth in production and a declining share of the fiber market, the market for cotton is unstable from year to year. Major production swings occur due to differences in weather and growing conditions, export demand for fibers, and U.S. economic conditions. Commodity boards of trade provide a market for risk diversification by farmers and cotton purchasers who are unsure of future cotton supply and demand. But weather and changing trade have still kept cotton prices unstable, causing variations in price of up to 50 percent from one growing season to another. For example, large crop yields in the 1979 and 1981 seasons, combined with a slowing of overseas demand for cotton fiber, led to sharply reduced cotton prices in 1982. And U.S. plantings of cotton for harvest in the 1983-84 season were down almost 35 percent, in response to low prices and new government acreage management policies.<sup>4</sup> Nonetheless, the United States remains a major world exporter of cotton; although exports fell off substantially in 1985-86, most forecasts predict a significant recovery for this marketing year. Japan, South Korea, and other Pacific Rim nations are the major purchasers of U.S. cotton, accounting for approximately 60 percent of U.S. exports.

Within the United States, nearly all of the cotton fiber grown and produced comes from the south and west. The top five cotton producing States are responsible for 75 percent of U.S. cotton production. Texas leads with 30 percent of the U.S. total, followed by California with 28 percent, Arizona with 13 percent, Mississippi with 10 percent, and Louisiana with 4 percent. Over 99 percent of U.S. cotton is the Upland variety; the remaining share is American Pima.<sup>5</sup>

<sup>3</sup>*Textile Organon*, Textile Economics Bureau, vol. 57, No. 5, May 1986.

<sup>4</sup>"Cotton Monthly Review of the World Situation," International Cotton Advisory Committee, vol. 36, No. 11, June 1983.

<sup>5</sup>*Textile Organon*, vol. 52, No. 1, January 1981, pp. 1-16.

Wool.-Wool production amounts to only 1.5 percent of U.S. mill fiber consumption, most of which is imported. While consumption has been rising in recent years, a growing share of that consumption was made up of imports.

### Synthetic Fibers

Without question, the major development in the fiber industry is the growth of the synthetic fibers sector. The first half of the 20th century was marked by the introduction of a large number of synthetic fibers, and the second half of the century by their rapid adoption by consumers. Rayon was the first major synthetic to be produced, starting in 1910. Acetate production began in the 1920s, followed by the production of synthetic nylon and vinyon, as well as rubber and glass, in the 1930s. During the 1940s, production of saran, metallic fibers, modacrylic, and olefin began. During the 1950s, acrylic, polyester, triacetate, and spandex came onto the market. In 1961, production of aramid fibers became commercial; by the mid-1970s, polyester had clearly emerged as the major synthetic fiber in the United States. By the end of the 1970s, polyester led all fibers—including cotton.<sup>6</sup>

In the apparel sector, manmade fibers account for nearly 60 percent of content. Blouses, ski wear, and hosiery are all examples of products that tend to have at least 60 percent synthetic content. For home furnishings, manmade fibers account for nearly 80 percent of content. For industrial textile products, the synthetic share is nearly 90 percent. Production of manmade fibers contributes 30 percent of its output to apparel, 34 percent to home furnishings, and 36 percent to industrial textile uses.

Growth of manmade fiber production and consumption in the mid-1980s is focused on the Third World. The number of manmade fiber-producing plants in the world is increasing, approaching 800 by 1984. The most recent increases have occurred primarily in India, with polyester plants up to 17 in 1984 from 11 in 1983 and nylon plants up to 10 from 8; Pakistan, with polyester plants up to 9 from 5; and Indonesia, with nylon plants up by 4. New fiber-producing facilities that have opened in developed countries since the late 1970s have been more than

offset by closings of facilities in these countries. Most fiber industry analysts expect little change in these trends in the future.

The U.S. synthetic fiber industry consists of approximately one dozen large multinational corporations, which are horizontally integrated. Du Pont, Celanese,<sup>7</sup> Monsanto, and Allied are entirely American-owned companies, and rank among the 10 largest world firms. The top 10 producers in the United States account for almost 90 percent of U.S. production. Du Pont, the largest, has far more fiber sales value than its closest competitor, Celanese. Du Pont and Celanese are followed by Allied, Monsanto, Eastman, Akzona, Badische, Hercules, and Avtex. Of the top five fiber companies in 1982, Celanese had the highest fiber sales as a percent of all corporate sales, at nearly 40 percent. If measuring size by corporate sales rather than fiber sales alone, Du Pont remains the leader, followed by Eastman and Monsanto.<sup>8</sup> These companies compete in the markets for six distinct fibers: polyester, nylon, acrylic, polyethylene, polypropylene, and acetate. Because production is mainly performed by the chemical industry—with the exception of Celanese—yarn production is not always counted in the textile industry.

There are two main types of synthetic fibers: cellulosic, which are dominated by rayon and acetate, and noncellulosic, which are dominated by nylon, acrylic, and polyester. Cellulosic fibers are increasingly giving up their market share to noncellulosic fibers.

**Cellulosic Fibers.** -In 1983, cellulose represented 7.7 percent of the total quantity of shipments in the manmade fiber market, measured in pounds, and 11.6 percent of the value. These shares marked a major decline from the levels of the early 1970s. In 1972, for example, the volume share of cellulosic fibers in the manmade fiber arena stood at 20.6 percent; the actual quantity of cellulose shipped between 1972 and 1983 fell from nearly 1.4 billion pounds to less than 630 million. The real value of shipments during the period also declined, as the 112-percent increase in the current dollar value of shipments was surpassed by an inflation rate of 138

<sup>6</sup>*Manmade Fiber Fact Book*, Manmade Fiber Producers' Association, Inc., 1980

<sup>7</sup>Celanese has recently merged with Hoechst, which may have changed some of these comparisons

<sup>8</sup>*Fairchild Textile and Apparel Financial Director*, 9th and 10th editions, 1982 and 1983

percent over the same time period.<sup>9</sup> These trends have continued since that time, although preliminary estimates from the U.S. Department of Commerce suggest a rebound in 1986 shipments.<sup>10</sup>

The major cellulosic fiber is rayon, which accounts for approximately 60 percent of cellulosic shipments. Rayon, a regenerated cellulose product, was the first manmade fiber patented. It was discovered in 1855 by Audemars, a Swiss chemist. The cellulose source for his product was the fibrous inner layer of the mulberry tree. Until 1924, rayon was called artificial silk. The first commercial production of this material was by the Frenchman Chardonnet, who became known as the father of the rayon industry. The first U.S. plant producing rayon was the American Viscose Corp., which opened in 1910. There were four rayon-producing plants as of 1983, down from 26 in 1950.<sup>11</sup>

The other large category of cellulosic fibers is acetate and acetate derivatives. Acetate, also a regenerated cellulose, was first commercially produced by Celanese in 1924. Production was halted temporarily during the Depression. As of 1983, there were five acetate-producing plants operating in the United States.

The major end uses of cellulosic filament yarn are for products of the apparel industry, though some home furnishing and industrial uses are also important. Six product categories using cellulosic yarn account for about 80 percent of consumption in the United States. These six categories are, in descending order of magnitude:

1. fabrics for lining apparel;
2. robes and loungewear;
3. drapes and upholstery;
4. topweight fabrics;
5. ties; and
6. underwear, nightwear, and bras.

All of the categories show a decrease in consumption of this yarn type in recent years, as other fibers continue to make inroads.

<sup>9</sup>"Manmade Fibers," "Apparel," *U.S. Industrial Outlook, 1984*, pp 40-5 to 40-8, 41-1 to 41-5.

<sup>10</sup>*U.S. Industrial Outlook, 1987*, op. cit., p. 41-4.

<sup>11</sup>*Manmade Fiber Fact Book*, op. cit.

<sup>12</sup>*Ibid.*

<sup>13</sup>*Textile Organon*, vol. 54, no. 9, September/October 1983

The major end uses of cellulosic staple fibers are dominated by products of the industrial sector, with over 30 percent of the fibers used by the medical, surgical, and sanitary category for disposable items. The top six major uses of cellulosic staple fibers account for about 82 percent of total U.S. consumption. These six categories are, in descending order of magnitude:

- 1 medical, surgical, and sanitary;
- 2 drapery and upholstery;
- 3 topweight fabrics;
- 4 miscellaneous industrial-type products;
- 5 bottomweight fabrics; and
- 6 sheets and other bedding.<sup>14</sup>

From 1976 to 1982, actual consumption of all fibers in these six categories declined by about 25 percent. The major declines in use were 57 and 39 percent, in the drapery and upholstery and the medical, surgical, and sanitary categories, respectively—in contrast to an increase of 18.8 percent for the other five categories as a group.

**Noncellulosic Fibers.**—Noncellulosic fibers represent the growth segment of the fiber industry. This segment is dominated by nylon, acrylic, and polyester. While noncellulosics are manufactured from a variety of products, petroleum is the predominant raw material in this sector. Between 1972 and 1983, the quantity of noncellulosic fibers shipped grew by 40.6 percent, with the value of shipments exceeding the inflation rate.<sup>15</sup> Noncellulosics also represent an area of significantly growing exports, with the value of shipments more than tripling over the period—from less than \$200 million in 1972 to nearly \$775 million in 1983.

Nylon 6,6, invented by Carothers in 1931, was first produced commercially by Du Pont in 1939. A nylon salt, produced through chemical processes, would "polymerize"—the small molecules were linked up to form long, chainlike molecules. This thick, syrupy material would then be hardened by a shower of water, chopped into flakes, melted again, and forced through the fine holes of a spinneret to form filaments of yarn. Nylon was introduced as a "miracle" fiber, which performed well in such diverse products as sewing thread, parachute fabric,

<sup>14</sup>*Ibid.*

<sup>15</sup>*Ibid.*, vol. 55, No. 3, March/April 1984, p. 35.

and women's hosiery. Its use became widespread in military applications during World War II, as a replacement for other materials used in tires, tents, ropes, and other defense supplies. At the conclusion of the war, 80 percent of the fiber consumed in the United States was still cotton, with manmade fibers, silk, and wool accounting for the remaining 20 percent. In the early 1950s, nylon became popular in carpeting and automotive upholstery, further increasing the manmade market share of fibers.

Because nylon is the major fiber used in carpeting and the demand for carpeting is largely determined by construction, the severe and cyclical curtailments in the construction industry were the chief reason for a decline of 11.1 percent from 1979 through 1983; by 1985, however, rug shipments had nearly recovered to their 1979 level. Noncellulosic fibers introduced in the late 1940s included strong metallic fibers by Dow Badische, modacrylic—a flame-resistant variation of acrylic—by Union Carbide, and olefin—a light fiber used for such items as boat ropes, since it floats in water—by Hercules. In recent years shipments of olefins have increased dramatically—by 80 percent between 1975 and 1983. Acrylic was introduced in 1950 by Du Pont as a manmade substitute for wool. A few years later the first wash-and-wear product was marketed, with fiber composition of 60 percent acrylic and 40 percent cotton.

Polyester, which is a petroleum-based fiber, was first produced in the United States by Du Pont, and in the rest of the world by Imperial Chemical Industries, in 1937. It dominates the manmade fiber market and accounts for over 40 percent of the market share, and over 28 percent of the market for all natural and manmade fibers. Despite its continued dominance in the field, polyester has experienced recent drops in total shipments—7.9 percent from 1979 to 1983. During the rest of the 1950s, research efforts into manmade fiber production turned from the development of new textiles to the modification, diversification, and commercialization of existing products. In the 1960s, spandex was introduced to the United States as a lightweight, highly extensible fiber. This was followed by the introduction of aramid, a lighter fiber but one that is tougher than steel.

In 1982, the top 12 uses of noncellulosic filament yarn accounted for over 85 percent of noncellulosic yarn sold in the United States. The 12 major end-

use categories, representing a mix of apparel, home furnishings, and industrial uses were, in descending order of magnitude:

1. carpets and rugs;
2. electrical and reinforced plastics;
3. bottomweight fabrics;
4. tires;
5. miscellaneous industrial-type products;
6. rope, cordage, and fishline;
7. topweight fabrics;
8. underwear, nightwear, and bras;
9. retail piece goods;
10. drapery and upholstery;
11. industrial narrow fabrics; and
12. sheer hosiery.<sup>16</sup>

The single category of carpets and rugs consumed over 20 percent of the noncellulosic yarns sold in the United States, with industrial uses dominating the remaining large users. From 1976 to 1982, the largest declines were found in the apparel categories, as imports and a switch to natural fibers moved bottomweight, topweight, and retail piece goods fabrics away from the noncellulosic fibers.

The category of carpets and rugs dominates the noncellulosic staple fiber uses, consuming over 25 percent of these fibers. There are 12 major categories of noncellulosic staple end uses. They are, in descending order of magnitude:

1. carpets and rugs;
2. bottomweight fabrics;
3. topweight fabrics;
4. fiberfill, stuffing, and flock;
5. sheets and other bedding;
6. retail piece goods;
7. drapery and upholstery;
8. craft and handwork yarn;
9. sweaters and related accessories;
10. medical, surgical, and sanitary;
11. anklets and socks; and
12. unallocated industrial nonwovens.<sup>17</sup>

The apparel categories of bottomweight and topweight fabrics, along with sheets and retail piece goods, consume large quantities of noncellulosic staple fibers, primarily as a polyester staple in the production of blended fabrics. The top 12 end uses of

<sup>16</sup>*Ibid.*, 1,01: 54, No 9, September/October 1983.

<sup>17</sup>*Ibid.*

noncellulosic staple fiber account for over 80 percent of the fibers consumed in the United States, with the largest single increase coming from medical, surgical, and sanitary use.

### ***Technological Innovations***

Innovations are occurring throughout the specific industry segments involved in yarn formation. Machines using new technology are capable of providing a four- to five-fold increase in productivity with respect to open-end spinning, and about a twentyfold increase with respect to ring spinning. In addition to innovations already being adopted, this section will review innovations that are pending or needed in fiber production.

#### **Innovations in Specific Areas of Yarn Formation**

**Texturing.** -Innovations in texturing have stimulated growth in the knitting sector. The ability to have heat set a crimp in synthetic fiber provides additional and desirable bulk to the fiber.

**Opening and Picking of Cotton.** -Traditionally, a bale of cotton had to be separated manually into layers and fed into hoppers, where the cotton was tumbled to break it into small tufts and to mix the cotton from various bales. The material was then transported, either by belt conveyor or through pneumatic ductwork, to pre-openers or cleaners, in order to reduce the tuft size and remove some of the non-dirt material. If the cotton was to be blended with other materials, such as synthetic fibers, additional hoppers similar to opening hoppers were used. Waste from the hoppers was manually removed. The next step was the production of a partially cleaned, flat, even sheet, in a roll, which was then hand-fed to the next stage, carding.

New technology in opening, cleaning, and picking has led to substantial automation of the process, increased productivity, improved product quality, and an enhanced work environment. Automatic bale plucking systems have been known to the industry since the mid-1960s, but their incorporation into the production process has just recently gained momentum. The carousels and automatic feeders, which pick off of several bales at once, have the following advantages:

- faster picking,
- a more intimate blend of cloth, since carousels can pick off of several bales of cotton at once,
- bypassing the manual picker, which eliminates the related back-breaking work, and
- eliminating some of the dustiest work of the production process.

**Carding Cotton.**—The purpose of carding is to further separate the fibers from the bits of leaf, trash, and short fibers, to straighten or parallel the cotton fibers, and to form a soft, untwisted, ropelike material called sliver. Carding is accomplished by bringing fibers over a feed plate to a feed roll and a cylinder covered with wire teeth, called the licker-in. The licker-in rotates rapidly over the lap of cotton held by the feed roll and gradually opens the tufts of cotton in the lap. As the tufts are opened, dirt and trash fall out. As cotton is processed by the card, fibers collect between the wires of fillet card clothing—consisting of fabric and wire—and must be stripped away traditionally by hand. Carding has traditionally been the source of greatest cotton dust exposure for workers, especially for strippers.

New carding technologies, especially chute-feeding systems, have been available since the 1960s, but their adoption in the textile industry accelerated only recently. The use of chute-fed cards encloses the process and removes the necessity for manual carding and for most manual cleaning. At least 11 production advantages result from the use of new carding technology:

1. elimination of doffing and racking;
2. elimination of the manual transport of materials to the card room, and of hanging the material onto cards and later into feed rolls;
3. improvement in yarn, since the automatic process on feed rolls reduces heavy places in the yarn;
4. more than doubling of speeds, in some cases by using metallic-clothed cards instead of flexible cards;
5. improvement in card settings due to roller bearings on cylinder supports, which allow for adjustments leading to more even clothing with closer tolerances;
6. better integration of fibers, resulting in a more uniform and stronger piece of yarn with improved sliver CV and weight variation;

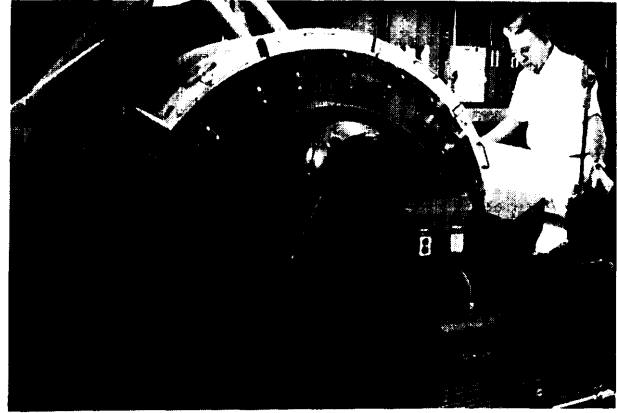
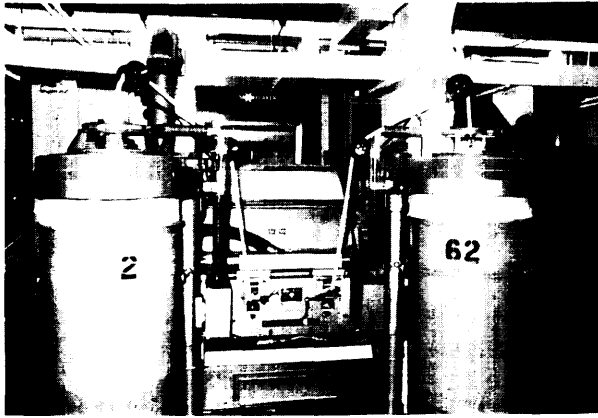

Photo credit: Charles Gardner, School of Textiles North Carolina State University

Pictured on left, a high-speed chute-fed carding device; on right, its technological predecessor, the lap-fed card.

7. improved spinning performance, due to sliver improvements, meaning fewer ends down;
8. reduced requirements for floor space;
9. reduced labor turnover by eliminating undesirable lap-laying tasks; and
10. reduced dust exposure due to enclosure of cards, and because hand cleaning of cards traditionally done twice a day can be reduced to once a week.

**Spinning.**—Spinning is the process by which fibers become yarn. The purpose of the spinning process is to stretch the sliver to its final diameter, and to insert the desired amount of twist. Thus, the yarn acquires its necessary strength. The traditional spinning method is called “ring spinning.” In ring spinning, bobbins are hung in a creel and ends are individually fed into drafting rolls. The twist is imparted by passing the yarn through a traveler on a ring while it is being wound onto bobbins placed on a revolving spindle. Fine trash and short fibers are often released into the air during this process.

Spinning has traditionally been labor-intensive, accounting for anywhere between 50 and 70 percent of all yarn manufacturing labor costs. More specifically, costs of spinners and doffers would amount to 50 to 80 percent of spinning labor costs, with high labor costs focused on cleaning, piecing, doffing, maintenance, and transportation.<sup>18</sup>

There has always been a strong impetus to try to reduce labor costs with the installation of more modern equipment—especially equipment that reduces ends down and repairs broken threads automatically. By the mid-1960s, a new technology called open-end spinning became commercially available. In open-end spinning, the open-end frame is supplied with sliver from a draw frame, eliminating the need for a roving frame; passes sliver through a drafting system into a centrifugal rotor; and creates a wound package, eliminating the need for a subsequent winding operation. When open-end spinning is installed to operate from sliver through winding, the number of conventional processes is reduced, thereby significantly contributing to an automated system.

Other advantages of open-end spinning, when applicable, include:

- increasing the production rate by four to five times that of the ring spindle;<sup>19</sup>
- the ability to process a far lower grade of cotton than ring spinning;
- reducing cotton dust exposure by enclosing the process and being more adaptable, which alleviates the need for local exhaust ventilation; and
- reducing the noise level in spinning rooms.

<sup>18</sup>Dan S Ham by (ed), *The American Cotton Handbook*, 3d ed (New York Interscience Publishers, 1965), p. 374.

<sup>19</sup>Centaur Associates, Inc, for OSHA, “Technical and Economic Analysis of Regulating Occupational Exposure to Cotton Dust,” vol. I, January 1983, p. 3-48

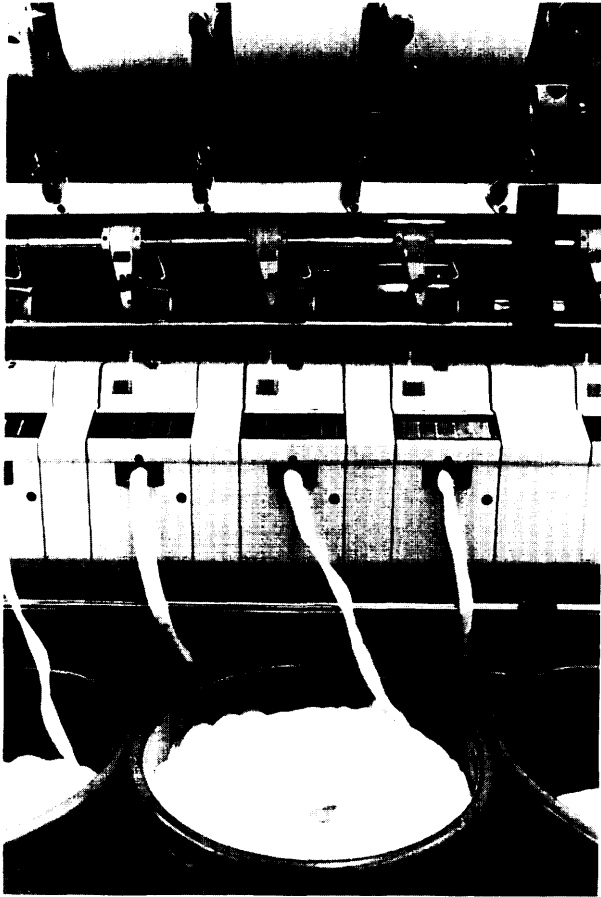

*Photo credit American Textile Manufacturers Institute*

Open-end spinning was introduced in the mid-1960s. It represented an improvement over ring spinning in terms of yarn quality, productivity, and safety.

There have also been innovations in spinning attachments. Automatic doffing (unloading) machines reduce unit requirements for doffer operators. Automatic devices for piecing (tying) broken yarn reduce unit requirements for spinners.

Winding.—Loading, or automatic creeling of machines with automatic tying-in of yarn ends, reduces unit requirements for operators. Integration of filling winding with weaving eliminates separate processes and associated handling.

### **Pending Innovations in Yarn Formation**

In general, the ideal yarn manufacturing process would take fiber from a bale, convert it to a sliver, and move it to a spinning process—such as open-

end spinning—with automatic transfer of the yarn output either to a warper or a loom. Emphasis would also be placed on computer monitoring of both quality and production rate, with the quality monitoring being tied to appropriate feedback and control mechanisms. The monitoring technology is already available for drawing, and technology for monitoring either open-end yarn or other kinds of yarn is on the horizon.

Another area of considerable importance with respect to monitoring is the ability to determine the need for machine maintenance by continuous monitoring of yarn production. This requires that all ends be monitored continuously, and that faulty positions be identified immediately. The repair, when it is needed, could be made automatically, or that end could be stopped and machine maintenance ordered. A useful system would also monitor and record long-term gradual deterioration, as opposed to short-term problems. The goal of the system would be to prevent the manufacture of defective material.

In general, it is important to measure and control quality at every step of the yarn formation process. Adequate computer technology is already available; the real problem seems to be the development of appropriate sensing elements.

There are a number of opportunities in the present yarn process for automated materials handling, including the use of robots. This is particularly true for systems that have reduced the number of process steps, such as open-end spinning, but it could also be used with ring-spinning technology, in which the automation of roving frames is a current need. Connecting winders to large spinning frames is a potential development, but winders need to be designed to accommodate some flexibility of yarn count. This could perhaps be accomplished by designing winders with space for extra positions. Such a linking technique would allow less handling of yarn packages—a distinct advantage, since it would also allow better package identification and control.

Although techniques for the continuous monitoring of various stages of yarn processes are available, knowing where to direct that information or what corrective actions to take is still largely unknown. Since it is necessary to be able to identify abnormal parts of the process, the real issue is to determine where in a process faults occur, what their interre-

lations with other process steps will be, and what feedback loops are needed to exercise control.

There is potential for the automatic analysis of incoming bales of fiber, particularly if robots or other automatic devices that could direct the bale to the appropriate storage area could be involved in the analysis. Automated bale storage is a labor-saving technology that leads to less handling, as well as presenting the opportunity of coding each bale for future identification. This is important because of the desirability of tracking the identity of the material in each textile process, from the initial bale through the final step. This, in turn, allows one to know the accurate history of all material and all processes, and allows for solutions of quality control problems based on more complete information.

#### **Development of New Fasciated Yarn Systems.<sup>20</sup>**

—Du Pent developed a fasciated yarn system in which there is never an open end, and there is a continuous strand from the core drafting system through the twister to the wind-up device. In the Du Pent system, fibers on the outside of the yarn have a different helical pitch to the fibers in the core of the yarn. An extreme case of this type of yarn structure occurs when the core fibers have no twist and the sheath is wrapped helically around the core, causing the whole structure to cohere. Developing from the Du Pent system, it becomes possible to contemplate laying fibers onto false-twisted yarn, with a fiber laid parallel to the axis of the yarn and anchored there, becoming a wrapper after it passes out of the false-twist zone. A stream of fibers landing on a false-twisted core creates a fasciated yarn having a twisted sheath, but a virtually twistless core. Alternatively, fibers can be raised from the surface of the yarn and then laid over the false-twisted core to produce similar effects. Fasciated yarn systems tend to prevent inter-fiber slippage.

**Alternatives to Rotor-Type Open-End Spinning.**—There has been considerable interest in alternatives to the rotor-type open-end spinning system. Pavék's rotating needle basket was used to capture fibers and consolidate them at the open end of a

<sup>20</sup>Two major ideas are involved in making fasciated or wrapped bundle yarns 1) the efficacy of using a wrapping filament or fiber to create fiber cohesion in an untwisted staple fiber bundle; and 2) the fact that when a fiber or part of one is laid on a false-twisted bundle, the laid-on fiber becomes a wrapper when the false-twist is removed

forming yarn. Goetzfried and others were interested in air-vortex systems, in which a helical or circular yarn end rotated inside a stationary tube and the yarn motion was caused by an air vortex. Fibers were injected into the tube and laid on the "open end." The major difference between these systems and the ones known today is the way in which the arriving fibers are brought into contact with the departing yarn. The common feature is that all these cases have an open end to the forming yarn.

**Development of Mixed Systems.**—It is possible for arriving fibers to be false-twisted into a core onto which a sheath is deposited. If the core is discontinuous with the core fiber supply, then the system is an open-end system. It can also be a fasciated system, by virtue of the sheath fibers which are laid onto false-twisted ones,

**Emergence of New Twisting Systems.**—Whereas conventional machines use a relatively massive rotating component to put in "twist," such as a ring spindle, a flyer, or a rotor, a new systems feature is for the twisting medium to act directly on the surface of the yarn. Where metal surfaces are used, it is possible to create a pair of counter-surfaces acting on a yarn. The frictional forces acting on the yarn surface create a torque which generates twist. Alternatively, fluid friction can be used. The most common of these latter types is an air-vortex, which can readily be made to rotate at extremely high speeds; the fluid friction creates the torque in the yarn.

**Creation of New Yarn Structures.**—Earlier experience with open-end yarns has shown that the disorderly sheath structure, with its tight wrapper fibers, causes a harsh hand and weakness, which have been major causes restraining growth of the open-end spinning system. These problems are being solved in some new machines through differences in the sheath fiber orientation.

#### **Needed Innovations in Yarn Formation**

While many innovations are being brought to yarn formation, more are envisioned. At least eight general technological developments are needed in the process of yarn formation, according to a study by the American Textile Machinery Association (ATMA):

1. higher speeds, better quality, universal systems in spinning;
2. uniformity monitoring in carding;



3. overall process consolidation;
4. automation, in process and quality control;
5. fewer steps in manufacturing;
6. sizing in the spinning and winding processes;
7. on-line analysis of the trash content of cotton; and
8. emphasis on friction spinning, with ring spinning becoming obsolete.<sup>21</sup>

The advent of the Murata air-jet spinning system and the Fehrer and Platt friction spinning systems have heightened interest in new forms of manufacturing staple yarns. Fehrer, Schlafhorst, and Suesen are working on a different friction spinning system, and Toyoda, Howa and others are working on different air-jet systems. It is believed that higher delivery speeds will become common, and that there will be different count ranges for each of the different systems. Air-jet and friction spinning will likely fill a gap left by rotor-type, open-end spinning.

### **Industrial Structure**

During 1985, domestic fiber output fell significantly. Even though cotton fabric shipments rose nearly 9 percent, manmade fiber domestic shipments dropped by 19 percent, and woolen fabric shipments from U.S. mills fell by 21 percent.<sup>22</sup>

As with the entire textile industry complex, one of the most important single factors influencing the economic future of the fiber sector is imports—both fiber imports, which compete directly, and fabric and apparel imports, which compete by reducing domestic demand. A positive balance of trade still exists in all synthetic fiber categories except cellulosic yarn and monofilament, but this surplus has shown substantial decline.

Between 1979 and 1985, developing nations were busy increasing their production of fiber. The growth was especially significant in noncellulosics, with China increasing its production over that period by 361 percent, India by 203 percent, and Indonesia by 102 percent.<sup>23</sup> China expects self-sufficiency in manmade fibers by the year 2000.<sup>24</sup> During the same period, U.S. production of noncellulosic fibers lost

world market share, from nearly 33 percent to 23 percent. In addition, cellulosic fiber production in the United States fell from 12.5 percent of world production in 1979 to 8.4 percent in 1985. U.S. employment in manmade fiber production during the decade from 1975 to 1985 fell by 41 percent—more than 40,000 jobs.<sup>25</sup>

### **Natural Yarns**

The fiber sector of the textile industry consists of both large integrated corporations and small flexible units that compete and trade with each other. The rivalry among producers is high, and there are an especially large number of competitors in the cotton yarn industry; there were approximately 270 firms in the industry through the 1970s. The concentration of the cotton industry is low and stable, at a level of 20 percent.

The cotton and wool yarn markets are characterized by low growth, making an expanded market share dependent on taking markets away from competitors. The different yarns are easy substitutes. The biggest problem in this sector is competition from manmade fibers, comprising 10 perfect substitutes for natural fibers. The resulting intense competition reduces profit margins. Cotton and wool yarn prices have experienced large decreases due to competition with synthetics.

Technology for natural fiber is largely supplied by a few machinery producers, of which none are U. S.-owned. The development of this machinery is only done by machinery producers. The turnover of machinery is frequent, making the technology used an important factor in competition. Productivity increases with new technology are high.

There is no potential threat from the suppliers to integrate forward, toward end use of the product; the agricultural and textile industries are too different, and their interests are on different levels. But there is a threat of backward integration by fabric producers. Yarn costs play a large part in the buyer's industry, yet the buyer's bargaining power is high. The reason for high bargaining power is that different yarn types are competitive, and the sector is characterized by frequent overcapacity.

<sup>21</sup> American Textile Machinery Association, "Needs Identification" Annual Meeting Report.

<sup>22</sup> *Textile Organon*, vol. 57, No. 8, August 1986.

<sup>23</sup> *Ibid.*, vol. 57, No. 7, July 1986.

<sup>24</sup> *Ibid.*, vol 57, No. 3, March 1986

<sup>25</sup> *Ibid.*

Entry and exit barriers into the industry are a question primarily of capital cost. Industries with the necessary financial resources can easily enter the spinning industries. Inexperience can be easily overcome with new technology, which is available in abundance.

Large-scale operations seem to have a competitive advantage in being able to reduce overall raw materials costs by purchasing large quantities. A key to achieving cost advantage is buying cotton at the right time. Cotton prices are largely a result of supply and demand in the U.S. commodity exchanges. As a result, cotton spinners try to buy cotton in large quantities at preferential prices; this, however, leads to large inventory costs. The more vertically integrated firms have a slight advantage in this competition, especially when the large firms are also their own suppliers and can add to the end-product stage. Competitive position depends heavily on the relative importance of yarn production in the overall enterprise.

On the other hand, there is some offsetting cost advantage for the smaller firms because of their higher flexibility in production. An example is Tuscarora Mill, a specialized yarn producer that carries a wide assortment of yarns. The success of the company lies in constantly finding market niches with high margins. Industry experts believe that flexibility of small firms will allow them to become more dominant in the marketing sense, which will create more small and flexible firms within the industry.

A strong future for the U.S. fiber industry will likely require a reduction in production overcapacity, and on emphasis on out-innovating competitors—not in basic fiber production, but through specialized products. The industry will shrink and become more competitive. Profits are likely to be low, unless some cooperation with the textile and apparel sectors of the industry is accomplished through vertical integration. Observations from machinery expositions indicate that small and flexible fiber production units are in demand by textile companies.

### Synthetic Fibers

The synthetic fiber industry is characterized by similar manufacturing processes, easy substitutability of products, similar markets, and similar expenditures in R&D. Texturizing and twisting, which add

to the desired quality of synthetic yarns, are two processes that distinguish manmade yarn production from natural fiber manufacturing.

Fiber shipments for some companies constitute a large amount of their total shipments. In 1974, Celanese had 50 percent of its business in fibers, and Avtex 100 percent. All other large chemical companies have a fiber business that is less than one-third of their total shipments. Major fiber firms have been reducing their dependency on fibers, with the exception of Badische.

Fiber markets are nearly saturated, and there currently is a problem of overcapacity; these markets depend largely on the apparel market, and U.S. apparel markets have suffered from severe import penetration. The two major fiber markets are the commodity market and the specialty market, each of which has its own distinct characteristics. While the United States is strong in the development of specialty fibers, its main outputs are commodity fibers.

Suppliers to the fiber industry provide raw materials and technology, and do research and development. Some fiber companies operate their own refineries; others must make purchases from competing multinational chemical companies.

There are substantial entry and exit barriers. Entry barriers in the fiber industry are a function of:

- large economies of scale,
- low product differentiation,
- *low* cost advantages,
- high capital requirements, and
- limited access to distribution channels.

Suppliers of the fiber industries have the potential of entering the industry. But fiber producers are unlikely to have the necessary resources to integrate backwards, into an even more capital-intensive industry.

Technology for the synthetic fiber industry is largely supplied by a few machinery producers, of which only a small percentage are U.S.-owned. The development of this machinery is done primarily by machinery producers. Updating of machinery is fairly frequent, so that the technology used is an important factor in competition, but is one over which most firms have little control. Some of the technology, however, is developed by fiber producers who keep proprietary rights on the developments.

### **The Throwing, Winding, and Thread Processes**

The throwing, winding, and thread industries consist of a few specialized firms—some vertically integrated, mostly throwing and winding, and some independent corporations, mostly thread—which compete in intermediate markets in the textile industry. Many of them are jobbers that serve the fabric-producing industries. They are defined by their similar manufacturing technologies, their similar distribution channels and markets, and their high capital expenditures for plant and equipment.

The throwing and winding industries (Standard Industrial Classification (SIC) 2282) and thread industry (SIC 2284) have similar technologies, but their structures are quite different. Throwing and winding firms face competitive forces similar to those of the spinning industries. The thread industry on the other hand, is characterized by its distinctiveness and flexibility. Both industries have high profitability but declining productivity.

Technology turnover is high in throwing and winding operations. Expenditures for new plant and equipment are primarily by large-scale operations. In contrast, the thread industries increasingly consist of small locations where little is spent for new machinery.

Throwing and winding represent mature industries that compete on a cost basis, and machinery replacement tends to replace labor. The industry is characterized by increasing concentration and high imports. But due to high profitability, imports are decreasing while exports are increasing.

The number of companies in the thread industry is low. All are highly specialized, serving their individual markets. Most of these companies are small and flexible. They are able to serve markets quickly, and to produce small amounts efficiently. The specialization of their service gives these companies an individual touch, especially in volatile markets where demand depends largely on the current quality behavior of the customers. Most of these companies are not diversified, and threads are their only products. Expanding market share is possible with an expanded product line, and it is relatively easy due to the low number and specialization of competitors. There is low standardization among producers; competitors can be distinctively different and unique.

Costs are a less competitive force in this industry. Profit potential is high, due to a favorable structure marked by high product specialization and low cost competition. Profit potential in the industry is also enhanced because entry barriers are only moderate, being a function of flexibility, capital requirements, and product specialization, and because exit barriers are low, since most of the machinery depreciates in a short time period. Profitability in the thread industry is largely determined by:

- the relative importance of the thread process in overall yarn production,
- the relatively low bargaining power of these corporations against their suppliers,
- the price consciousness of their customers, and
- low barriers of entry and exit—especially the forward integration of the yarn industries.

The thread industry is still in a growth period. Exports are increasing rapidly, and imports are at low levels. Employment has actually increased, and these small companies benefit from their flexibility in the marketing sense. One might expect that the small thread firms would form excellent cash cows for larger textile corporations, especially spinning industries which buy thread. As long as thread producers maintain their uniqueness, however, their solid bargaining position will make vertical integration less likely to occur.

### **General Prospects for the Fiber Industry**

The U.S. fiber industry is in the middle of massive structural change. Part of the current situation is caused by the technological maturity of the whole fiber-textile-apparel industry complex. Part is due to the shift from natural to manmade fibers. And part is caused by an erosion of the competitive base of the United States as a place for production, even for capital-intensive industries.

The U.S. fiber market is mature and saturated. Massive overproduction has depressed prices in a low growth market. High investments in machinery, aimed at gaining a competitive edge by means of productivity and a reduction of costs, have not yet resulted in satisfactory returns.

Furthermore, one can observe a drastic change in international fiber production. The Far East—

especially South Korea, Taiwan, Japan, and China—is expanding fiber production, and may soon exceed the production level of West Germany. These countries are expanding their production in areas that western countries once dominated. The plants under construction in many developing countries indicate that these countries use the fiber industry to gain a niche in international markets, and not simply to satisfy their own demand for textiles and apparel. Most projects are financed by western banks, and the technology is usually sold by European countries.

With the exception of Japan, fiber producers in developing countries are following the strategy of competing in basic fibers on a cost basis. Japan, on the other hand, produces high quality and highly specialized fibers for export. The success of these strategies is evidenced by the growing import penetration of fibers into the United States.

## TEXTILE MILL PRODUCTS

Like the fiber sector of the industry, fabric formation has undergone changes in both technology and business structure. New weaving machines have been responsible for increasing the speed of production and the quality of the product, while at the same time improving the work environment. Because of the high cost of new machinery, adoption of the new technology has been primarily by the largest and most profitable companies. New economies of scale have caused mergers and consolidations, the building of new plants, and the closing of old ones. While the textile mill sector of the industry leads U.S. manufacturing in productivity increases, it has been hit by a flood of imports that threaten profits and even survival.

### **Background**

The textile mill products sector of the textile industry includes all operations that are involved in converting fiber to finished fabric and the production of many nonapparel consumer products. The health of the U.S. textile mill production is clearly affected by the health of the U.S. apparel sector, with some estimating that loss of the apparel sector would almost certainly doom 35 percent of the domestic textile industry.

U.S. and European fiber producers' strategies to counter these trends in international markets have been diverse and, more or less, successful. The most apparent move is to reduce dependency on low-cost fiber producers, as is being pursued by Du Pont, American Enka, and Rhone Poulenc. These companies are also establishing production facilities in developing nations, to overcome the political trade barriers that sometimes prevent access to overseas markets.

The big American fiber companies are still trying to compete on a price basis with imports, whereas in European countries there is increasing emphasis on specialization and service. One can expect that it will be some time until U.S. fiber producers change their strategies of high volume and standard fibers, since most developing countries produce the same fibers.

The textile mill products sector is the tenth largest industrial employer in the United States, with approximately 700,000 people—86 percent of whom are production workers. Shipments total over \$50 billion annually. The industry is characterized by substantial productivity increases but sagging earnings, increased capital investment but declining employment, and plant expansions as well as plant closings.

The largest textile company in the United States is Burlington Industries, followed by Stevens and Milliken. Other major textile manufacturers are West Point Pepperell, Springs Industries (which has now acquired Lowenstein, on its own a major producer), Dominion Textiles, Collins & Aikman, Cone Mills, United Merchants & Manufacturing, Dan River, Fieldcrest, and Riegel. The top 12 publicly held U.S. textile mill companies produce approximately 26 percent of total sales dollars. The typical large public textile company showed a 10-year average return on sales of about 3 percent, and a 10-year average return on equity of about 9 percent.

### **The Traditional Production Process**

The major traditional production processes for woven fabrics are winding, warping, slashing, weav-

ing, and finishing. In addition, there is fabric that is knitted or manufactured using other nonwoven techniques.

**Winding.**—The output of spinning machinery is spindles of short-length yarn. These spindles cannot be used in the next production process because they are of unequal length, because there is not enough yarn on a spindle, and because the spindle size is unsuitable for the weaving and knitting processes. For these reasons yarns must be rewound onto large packages suitable for the appropriate production process. Weaving requires a different package than knitting. These different requirements for the next processes make a uniform winding process almost impossible. Low-quality yarns perform badly in winding, and weak spots in yarn are detected through yarn breakage. Recently, most winders have been equipped with automatic splicing devices to prevent the knots that can enter yarn from repair of breaks. These splicing machines detect a break problem, pick the two ends up, and splice them together. Such devices decrease the labor intensity of the process, as does automatic feeding of the individual winding positions.

**Warping.**—The warping process produces the “warp” threads for weaving, which run lengthwise. The goal is to reach a very high density of yarns on the beam for the warp; 400 to 700 yarns are wound onto the beam at once. This is done at a high speed, with great attention given to the tension of the yarns. A frequent problem is the uneven length of the yarn on the packages. The more precisely the winding process is performed, the fewer the unused yarns left over in the warping process. Still, the warping process is time-consuming. The packages are manually put onto a frame, where the yarns are guided through a reed, which separates the individual yarns and ensures that they stay parallel.

**Slashing.**—Four to six beams are run together on a slasher to achieve the correct density and amount of yarns on the warp beam. Yarns receive a protective coating that shields them from excessive abrasion during the weaving process. Without this treatment, most yarns would not stand the constant friction and tension; the result would be frequent end breaks, with an associated decrease in productivity. The “chemistry” used in the slashing process is confidential in every weaving plant, due to the significant differences it can account for in the efficiency of the weaving process.



m m

**Weaving.**—Weaving transforms yarn into fabric by interlacing lengthwise warp yarns and widthwise filling yarns at right angles. A warp is planned for several pieces of fabric, which are usually about 300 yards long. To keep the efficiency of weaving plants high, changes in the warp on the loom must be carefully planned. Computer-aided production monitoring of the complete weaving process helps to keep the looms running at high efficiency levels.

There are several basic weaves. The simplest is called the plain weave, in which pieces of yarn pass over and under each other alternately. In the twill weave, the filling yarns go over and under two or more warp yarns at regular intervals, creating a diagonal pattern. In satin weave, the intersections of warp and filling are varied, resulting in a tightly woven cloth with a smooth appearance. One of the most famous looms for intricate patterns is the Jacquard loom. The pattern for this fabric is programmed on a series of punch cards similar to modern computer cards. The cards, in turn, manipulate the warp yarns to create the desired pattern. Flowered bedspreads, towels, and decorative fabrics such as upholstery are produced in this way.

**Knitting.**—The knitting process is divided into several distinct segments. Some knitting mills are like weaving mills, in that they manufacture rolls of fabric for shipment to apparel plants to be cut and sewn. Others specialize in particular apparel, such as knitted underwear, sweaters, pantyhose, and socks. The different types of knitting are usually made on different machinery and in different plants.

The basic distinction between knitting and weaving are that the woven yarns are interlaced together and the knitted yarns are looped; a knitted fabric is a series of interconnected loops. The most frequent knitting processes are weft or warp knit production, performed on a flat bed knitting machine or on a circular knitting machine, and single or double knit production.

The knitting process consists of hundreds or thousands of needles in a row or a circle, which pull yarn through the loops. The spacing of the needles determines the gauge of a knitting machine. The whole process makes the impression of being more continuous than the weaving process. The number of knitting positions determines the productivity of the machinery. All yarn preparation processes through winding are required in the knitting process, but neither warping nor slashing are necessary. Yarns come to knitting directly from the winding machine.

**Nonwoven Fabric Manufacture.**—Some nonwoven fabrics are produced directly from fiber by machines that apply combinations of heat and pressure to fuse the fibers into fabric. Fabrics that are bonded this way have greater porosity, better shape, higher bulk, and nonraveling edges. Other fabrics are “needle punched,” or produced directly from fiber by machines that tangle or mat fiber. Laminated fabrics consist of two fabrics, or fabric and a material like urethane foam bonded together by heat or chemicals.

One very popular nonwoven process is tufting. Tufting is the most widely used process for carpet manufacturing. In this process, a bar carrying a row of closely spaced needles is positioned above a flat backing fabric. Each needle is supplied with a yarn drawn from a separate yarn package, forming one of a number in a creel in the back. The needle bar is lowered so that the needles pass through the backing fabric to a controlled distance, where a corresponding number of loopers are positioned. Defects in the fabrics are easily corrected by a hand tufting machine, without any quality loss. One tufting machine usually requires one operator. The tufting operation is capital-intensive, and there is potential for future automation of the process with concurrent increases in productivity.

**Finishing.**—Fabric must be bleached, dyed, or printed before it is ready for use. [It may also be

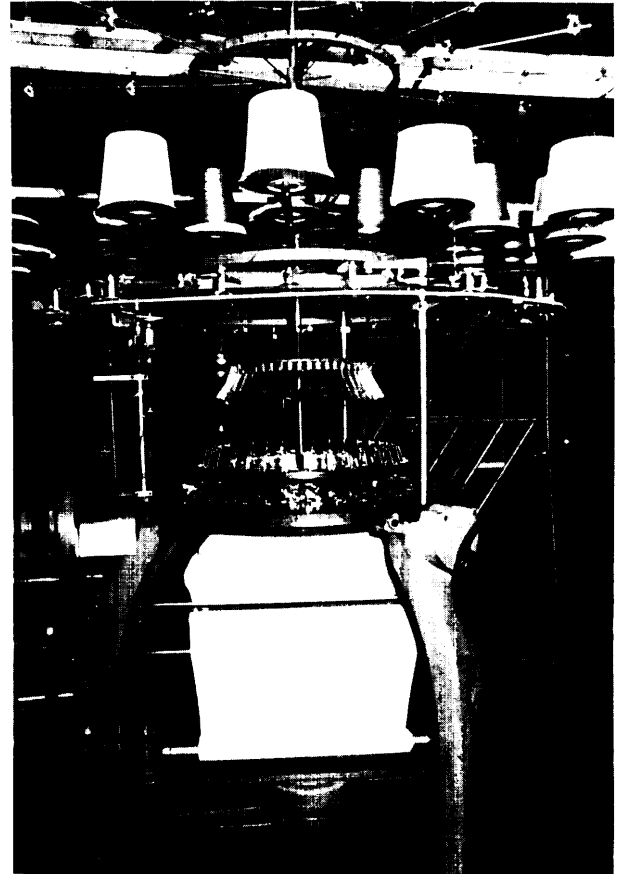

Photo credit" Charles Gardner, School of Textiles, North Carolina State University

A traditional, plain-jersey knitting machine,

sheared, brushed, or scrubbed. Fabric may be treated to repel water or to absorb it. It can be finished to make it rigid or soft. Some textiles are coated with plastics, in order to produce the look and feel of leather. Others are finished to look like the fur of wild animals.

### ***Technological Innovations***

Innovations are occurring throughout the process of fabric formation. In addition to innovations already being adopted are those pending development and those that need to be developed.

#### **Innovations in Specific Areas of Fabric Formation**

**Weaving.**—Traditionally, weaving has been accomplished on a shuttle loom. A new technology



for weaving, the shuttleless loom, has emerged since the 1950s, and has virtually revolutionized the weaving process.<sup>26</sup> These looms operate at faster speeds and require fewer auxiliary operations than shuttle looms. The four basic types of shuttleless looms are:

1. missile or projectile;
2. rapier—flexible, rigid, and telescopic;
3. air-jet; and
4. water-jet.

There are also multi-phase looms, which may combine weft-wave or warp-wave systems with shuttleless technologies.

Although the majority of the world's weaving industry is still dependent on shuttle looms, there is no doubt that their share of the market is steadily decreasing. Rapier and projectile looms have been the most widely used since the mid-1970s. Water-jet looms were more widely accepted than air-jet, mainly for filament weaving, because of their greater width and speed. Recent advances in air-jet looms, however, give air the edge over water, and air-jet weaving is expected by many experts to be the most widely used shuttleless system of the late 1980s.

**Projectile Looms.**—The two basic types of projectile looms are the single and multiple projectiles. Single projectile looms have not made a major impact in the industry, due to low rates of filling insertion.

<sup>26</sup>This discussion of specific types of shuttleless looms is based largely on M.M. Mohamed, "The Current State of Weaving," North Carolina State University, Raleigh, NC, 1984.

The projectile is accelerated and stopped by compressed air. Major manufacturers are Investa and Crompton & Knowles.

Multiple projectile looms are manufactured by Sulzer, although others produce the same loom either by license or by duplicating the Sulzer loom. The gripper or projectile used on the Sulzer loom is capable of inserting the filling in one direction only, and is projected at a speed of approximately 100 feet per second through guides. The grippers are returned to the picking side by means of a conveyor chain, one per 10 inches of chain length.

The Sulzer loom introduced a number of new concepts to loom design. The first is the use of strain energy of a torsion bar to activate the picking. The second is the use of cam-driven lay with a long dwell in the back center, and the use of guides to ensure a straight line path for the projectile. Other new features are tucked-in selvage, and a different reed design that allows for more air-space between wires. This particular design is thought to be responsible for the reduction of warp breaks on the Sulzer loom.

The Sulzer loom is a highly engineered machine, which has been refined over a 30-year period. The loom is available in tappet, dobby, or jacquard, and in single- or multi-color filling. A new and significant development is the Crompton & Knowles air-propelled projectile, in the form of a tube: a length of filling sufficient for one pick is crammed into the plastic tube prior to the insertion. Picking occurs from both sides, as on conventional looms.

**Rapier Looms.**—The three basic types of rapier systems are rigid, flexible, and telescopic. In some cases, only one of these three types is used to insert the pick from one side to the other. In other cases, two rapiers are used, and one of the rapiers takes the filling yarn to the center and delivers it to the second rapier, which then takes it to the other side of the fabric. New developments in rapier looms include considerable refinements in weaving a wide range of yarns, offering four-, six-, and eight-color selection mechanisms for filling. Increased width and speed of most rapier looms qualify them to be considered by many as the conventional looms of the future.

One of the most significant developments in rapier looms is the two-phase Sauer-500, in which a rigid rapier is used to insert the filling in two fabrics

woven side-by-side on the same loom. This development eliminates the space requirement problems of the single-rigid rapier loom. The rapier is driven in the middle of the loom, and enters one warp shed as it leaves the other shed. All functions of the loom lag by a phase angle of 180 degrees on one side, as compared to the other side. A rate of filling insertion of up to 1,100 meters per minute is possible.

**Air-jet Looms.**—Even though air-jet loom development can be traced back to the 1920s, the modern era in air-jet weaving has taken place over two stages. The first stage was the development of the Maxbo loom. Each loom had its own compressor, and was limited in width to about 100 centimeters because no control was used on the air flow through the shed. Due to this limitation, air-jet weaving did not receive much attention during the early 1960s. The second stage, which started in the late 1960s and early 1970s, is characterized by the development of jet control systems and the use of auxiliary nozzles. These events made it possible to have loom widths up to 330 centimeters and speeds up to 600 parts per minute. Many experts believe that air-jet looms will increase their share of the shuttleless market, especially at the expense of water-jet looms. This is mainly due to the flexibility of air-jet looms in weaving filament and spun yarns.

The three main types of air-jet looms are single nozzle with confuser type guides, multiple nozzles with guides, and multiple nozzles with profile reeds—each of which has advantages and disadvantages. Systems that use guides tend to suffer from a high level of abrasion between the guides and the warp. The use of a reed reduces the level of abrasion, but tends to increase the cost of production due to the high cost of the reed; however, Ruti, the Swiss company, has developed a semi-profile reed, which can be used with plain weave fabric and reduces the cost of a profile reed.

Although modern air-jet looms represent a tremendous advance in weaving, there are still limitations to be overcome. One example is the restriction on multi-color filling. Even though Ruti has developed a system of filling mix that uses two main nozzles oscillating up and down, only one color was used. Also, the use of fancy yarn in the warp or filling direction still presents a major challenge. In addition, fabric weight is limited to light and medium weights of about 400 grams per square meter.

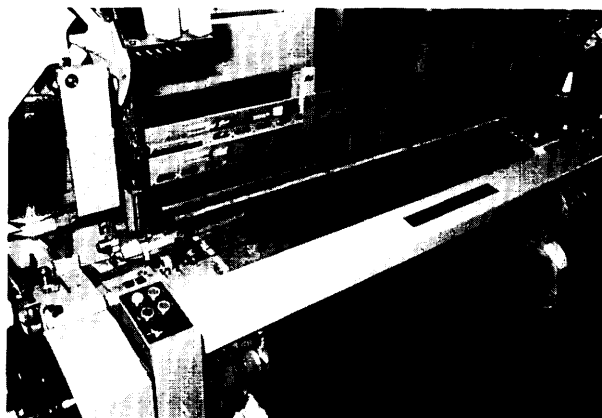

Photo credit Charles Gardner, School of Textiles North Carolina State University

An air-jet loom: Electronic controls help make this technology faster and more efficient than shuttle looms.

**Water-jet Looms.**—With water-jet looms, a water-jet takes the yarn across the shed. Water-jet looms achieved higher speeds at larger widths than early air-jet looms. But water-jet looms have the disadvantage of being limited to filament synthetic yarn. Other disadvantages are that the warp has to be sized with a nonwater-soluble size, and that the fabric has to be dried.

Although experts predict reduced market growth for water-jet looms, there are two recent important developments. First, Nissan has developed a “Super Speed” loom that operates at a speed of 700 parts per minute with a 72-inch width. Second, Investa has modernized its OK-6/H2000 loom to use two central nozzles at the middle of the loom, thus enabling the loom to weave double-width and to use two-color filling. Water-jet looms have also been very successful in weaving fiberglass, lining, and taffeta fabrics.

**Multi-phase Looms.**—instead of the sequential functions of shedding, filling insertion, and beat-up of single-phase looms, a multi-phase loom can perform these three functions simultaneously and for more than one shed. The two types of multi-phase looms are weft-wave and warp-wave.

In the weft-wave system, the warp shed is divided into a large number of sections that operate independently from one other. Filling carriers have a piece of yarn long enough for one pick, and enter the warp from one side. As they progress across the warp, each shed changes for the next carrier. Beat-



up of the pick also occurs in segments, after each part of the pick is inserted. The most important feature of this type of loom is a high rate of filling insertion achieved at a reduced noise level. The main drawback is a limitation on yarn range and fabric design.

With the warp-wave system, the sheds are created for the full width of the warp. Filling insertion occurs in more than one shed simultaneously; beat-up is done over the entire pick. The Bentley "Orbit" loom operates on a curve's cylindrical warp path, and claims to reach a rate of filling insertion of 3,600 meters per minute for a two-fabric loom, using rigid rapiers to insert 18 picks simultaneously in each of the two sides at the rate of 100 times per minute. The "Orbit," however, suffers from limitations of fabric width and design construction.

An ongoing development that will combine the use of air-jet insertion and flat warp-wave shedding is the McGinley loom, which uses conventional shedding like cam dobby or jacquard. Using guides that will become a tube for the air and filling insertion, the amount of air needed per pick will be considerably reduced.

Shuttleless looms have the following advantages over traditional fly shuttle looms:

- productivity of some shuttleless looms is as much as three times that of conventional shuttle looms;
- cloth can have greater width;
- cloth flaws are reduced, thus improving fabric quality and marketing;
- noise levels in weaving rooms are reduced;
- temperature and humidity control, demanded by the sensitivity of the machinery, improve both the cloth quality and the work environment; and
- traveling cleaners on the equipment take care of more dust problems at the source than traditional cleaners.

**Dyeing and Finishing.**—There is a general view that the number of discrete processes in dyeing and finishing needs to be substantially reduced, and that as many as possible should be combined. The goal would be to make dyeing and finishing a truly continuous process, rather than a series of batch processes each with its own control and materials handling problems. What this suggests is the development of

sophisticated monitoring and control systems for dyeing and finishing, the more important of which seem to be the ability to monitor and control both the color of wet fabric and the moisture content. The aim is to be able to predict accurately the color of the final dry fabric by measuring its characteristics at the moment it is being dyed.

Continuous dye ranges now have considerable automation, but they are hampered by an inability to run very small lots efficiently. Systems need to be developed that will allow rapid changeover from lot to lot on a continuous range system, with a minimum fabric band between the changes. In addition to suitable monitoring and control functions, ways to rapidly alter dye baths in order to change color must be developed quickly. The aim is to produce systems with very rapid response times. This will require precision instrumentation for adding chemicals and controlling the parameters of the process.

It is also important to have absolutely uniform desizing and bleaching. In this area, there may also be applications for computer-based monitoring feedback and control systems. There are general needs for reducing the energy cost in dyeing by reducing either the setting or the drying requirements. For some products, it would be useful to have dyeing be the last of all finishing steps, in order to improve order and warehouse versatility. Finally, the development of continuous computerized finishing integrates dyeing and finishing techniques, incorporates computerized instrumentation, reduces unit labor costs, and improves quality.

### **Innovations in Fabric Formation<sup>27</sup>**

Automation is a major trend throughout the textile industry complex; most current applications of robotics are in the area of materials handling. An important concept, related to automated materials handling, is automated identification of the material, which allows for the recognition of quality control problems with respect to their material source. Such automated materials handling is, or eventually will be, built into process technology itself, but ma-

<sup>27</sup>The following discussion is based largely on D.R. Buchanan and G.A. Berkstresser, "Automation in the Textile Industry: Prospects and Impacts," North Carolina State University, Raleigh, NC, cited in "Technologies for the Textile and Apparel Manufacture in the U.S.," contract report prepared for the Office of Technology Assessment, February 1985, pp. 295-309.

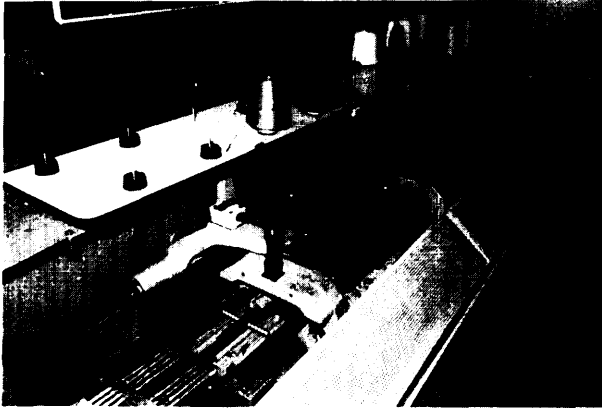

Photo credit: Charles Gardner, School of Textiles, North Carolina State University

This modern knitting machinery permits increased flexibility and productivity in fabric formation.

materials handling problems that will require special technologies remain—the newest of which are driverless vehicles and robots. Of all the technological developments emerging in the textile and apparel industry, the increase in automation and monitoring of fabric production processes has had the largest impact on productivity and product quality.

**Pending Technologies.** Pending innovations in fabric formation are almost all in the areas of monitoring and control, inspection, and materials handling. Modern weaving and knitting machinery allows the choice of many options, facilitating the decision of whether to emphasize productivity or flexibility. The important trend outside the design of fabric formation machinery is the elimination of menial materials handling jobs. As an example, fabric handling with driverless tractors is well proven, although this is an area in which potential savings—other than those associated with labor—are difficult to identify. In conjunction with automatic inspection and grading, it would also be desirable to devise systems for automatic doffing of cloth and automatic cutting.

Inspection of fabric is thought by many to be a process that might be eliminated if suitable process monitoring and control systems are invented. There is, however, a difference in philosophy, depending on whether a greige mill or a dyeing and finishing plant is involved. In the former case, it is more likely that inspection could be eliminated if the finished fabric is inspected later; there will always be a need for some inspection, but it can be automated. In par-

ticular, inspection systems should be capable of viewing the fabric with both plant capabilities and customer demands in mind, changing the latter with respect to the customer and changing the former with respect to the fabric style. Computer-controlled inspection systems should also interface with computer-controlled cutting systems, to optimize the cutting of quality yardage. These issues become more important as the textile industry moves to higher quality and greater output levels, when inspection speeds could limit process speeds.

Monitoring in weave rooms and other fabric formation areas is done generally for the purpose of producing management information. Although this is an important function of such systems, diagnostic monitoring that will locate and diagnose loom malfunctions—preferably before they lead to producing off-quality material—are also needed. Such systems would be part of a larger monitoring system that could deal with the flow of raw material into the fabric formation process, or with the fabric formation itself. The development of truly reliable monitoring and control systems is closely related to the development of automated inspection systems, since the latter depend on the assurance that defects are minimized in the process.

**Needed Technologies.**—The technological revolution has already occurred in fabric formation, with the development and increasing adoption of shuttleless weaving. Nonetheless, at least six technological developments are expected to be the focus for future advances. These developments center around increasing the amount of automation in the process, reducing the number of manufacturing steps, and gaining fuller control over production processes than over changing machinery technologies. The six developments are:

1. monitoring and controlling of slashing,
2. weaving without size,
3. new slashing techniques,
4. fewer steps,
5. built-in cleaning, and
6. microprocessors and CAD/CAM<sup>28</sup> for loom changes.

**The Impact of Robotics.—Robot v. Hard Automation.**—While hard automation dominated techno-

<sup>28</sup>Computer-aided design/computer-aided manufacture

logical developments in the textile and apparel industry of the past, some predict that robots may be the trend of the future. To date, new technological developments in the industry have emerged primarily from custom-engineered, automated manufacturing machinery, built to accomplish a specific set of tasks and incapable of doing other tasks without disassembly and rebuilding. This process defines “hard automation.” Robots, however, whose applications have already revolutionized the automotive industry as well as some simple textile tasks, are defined as:

... reprogrammable multi-functional manipulators] designed to move material, parts, tools, or specialized devices through variable programmed motions for the performance of a variety of tasks.<sup>29</sup>

Clearly, a robot is something quite different from a piece of machinery classified as hard automation. The extent of future automation through the application of robots is still an issue of hot debate within the textile and apparel industry.

Hard automation is used for such technologies as automatic knot tying devices, which do what humans had done previously with greater consistency. Modern techniques of yarn splicing, however, represent a process that humans cannot duplicate. Other developments include faulty end detection using computer-driven detection systems, and production monitoring using computer-controlled systems. Also, among the more inventive materials transfer schemes are ring-spinning yarn packages brought to a winding frame.

Currently available robots can have most, if not all, of the following characteristics:

- spatial flexibility, with up to 6 degrees of freedom,
- teaching and playback capability,
- memory of any reasonable size,
- program selection by external events,
- position repeatability to 0.3 mm,
- weight handling capability to 150 kg,
- point-to-point or continuous path control,
- synchronization with object movement,
- interface ability with external computers, and
- high reliability—typically 400 to 500 hours between failures.

*Pending Developments in Robotics.*—Textile uses for robots will probably not become revolutionary

but will remain evolutionary, until most of the following seven items have been developed to the point that they are available at a reasonable cost:

1. vision, for recognition, parts orientation, and flaw detection;
2. tactile sensing, for recognition, orientation, and physical interaction;
3. real-time, computer-based interpretation of visual and tactile data;
4. general-purpose versatile effecters, or “hands”;
5. mobility, or the ability to move from one work station to another;
6. self-diagnostic error tracing; and
7. inherent safety.

Entire robot systems, in which integrated and interrelated technologies operate with a minimum of human supervision and intervention, are likely possibilities for the future. Hard automation will likely be part of such an automated factory, unless some way is found to substitute some of the successfully automated textile machines with robots. Most experts predict that hard automation will be accompanied by robots, particularly in materials transfer assembly and special operations applications. At the front end of such a factory, it could be expected that computer-aided design, as well as transfer of instructions and information directly to the manufacturing machines will be a featured. In addition, information from a sophisticated computer-based system will be sent to management for use in decisionmaking.

Three areas for likely use of future robot systems in the textile industry are materials transfer, inspection, and process control. More sophisticated systems of materials transfer are likely to emerge, especially with respect to mobility; a number of spinning frames could be served by one system, for example, and the output directed to a number of places. These materials transfer systems will also have much more sophisticated sensing systems, and may even monitor quality as they perform transfer tasks. More sophisticated versions of the driverless vehicles now available are also likely to emerge. These may have even more sophisticated computer control, and would probably not depend on floor tracks for their guidance system. If the latter were developed, this would represent peak flexibility for these devices.

Effective inspection will take place automatically at many more positions in the textile processes of

<sup>29</sup>The Robot institute of America



Photo credits: Charles Gardner, School of Textiles, North Carolina State University

This robotic device (above) inspects yarn to determine whether yarn quality is sufficient for knitting. Such technologies are replacing the hand inspection process (below), and allow for greater flexibility, more accuracy, and faster speed during inspection.

the future than in those of today. Inspections will utilize rapid response, vision, and/or tactile systems in some cases; in other cases, transducers will measure physical properties. In addition, the overall inspection system will be programmable, to allow decisionmaking based on both plant and customer specifications; these may be changed nearly instantaneously as the product being manufactured changes. Finally, such a system has to provide a complete management information package on demand, and this probably will be a built-in part of future innovations.

Real-time, efficient sensing systems will be needed for process control, and these systems should be able to operate at nearly every phase of the textile product manufacturing process. In addition, they will have the ability to maintain complete records of a product's history, and of its complete component and process identification. This will be extremely useful when production difficulties occur.

Robots represent a logical extension of the hard automation developments in textile technology, which started with the Industrial Revolution. The importance of future developments will depend on the degree to which robots and hard automation are combined with computer control of design and information systems, in order to form flexible automated factory systems capable of producing high-quality, low-cost products that can be sold profitably.

*Impact of Automation on productivity.*—The cumulative effect of a continuing flood of inventions since the Industrial Revolution, mostly in the hard automation class, has been dramatic improvement throughout the textile industry. In each 70-year period since 1760, productivity in yarn and fabric formation increased tenfold. The introduction of robots into the industry should assure a continuation of this historical trend of rising productivity.

The improvement of quality in processes that use sophisticated automation, and particularly in robot applications, is largely the result of enhanced repeatability and reliability. Depending on the job, it is possible not only to work more efficiently, but to effect savings in parts or supplies because of the greater efficiency of robotic applications. This can be facili-

tated by interfacing with feedback and control loops for rapid response to external events. Finally, there is a view that human intervention in the manufacturing process should be restricted to the greatest extent possible, in that many human functions, such as handling, are actually detrimental to quality.

The enhancement of flexibility occurs particularly with robotic applications, due to the possibility of reprogramming in a simpler fashion when circumstances dictate. Since there is an identified trend in the textile industry towards increased levels of manufacturing adaptability, the flexibility built-in to automation can be of value to a firm that is close to the marketing and fashion end of the business. While humans represent the ultimate in flexibility and adaptability, it is quite conceivable that robots may be able to replace some human functions in manufacturing processes that require high levels of flexibility.

***Impacts of Automation on General Management.***—Over the centuries of development in the textile industry, management has had to adapt to change, but the rates of change of the past were more gradual than those of today. Frequently, “trial and error” methods of adaptation worked. But the predicted rate of change that will face the industry over the next several decades may be so rapid that management will not have the luxury of a long time period in which to adapt. Those who wait and try to adapt to future changes, rather than planning for their emergence, may not survive.

For the U.S. textile and apparel industries to enjoy the benefits of robotic systems applications, management must recognize that entirely new approaches to human factors and financial management maybe required. The structure of the industry may have to change in order to survive in a global market economy; indeed, the \$55 million spent by Burlington Industries to modernize its Erwin plant is going to look very small in a few years. Even with moves toward higher value-added products, survival is not guaranteed.

Recent research on textile industry structure indicates that large firms, with access to large amounts of capital and large economies of scale, show the highest productivity using the value-added measure. Small firms, with the least access to capital but high flexibility and usually producing high value-added

products, have the next highest productivity. Medium-sized firms, which have been a very important segment of the industry, face both limited access to large amounts of capital and limited flexibility, resulting in the lowest productivity. As the industry moves toward a more capital-intensive structure, the dominance of larger firms increase.

***Impact of Automation on Human Factors Management.***—The impact of automation on human factors management will be pervasive. The following areas are likely to change;

- traditional practices of recruiting large numbers of low-skilled workers, and relying primarily on on-the-job training, may need revision;
- fewer workers will be needed, but those who are needed may have to possess higher skill levels;
- textile companies may not be able to afford traditionally high annual labor turnover rates;
- management may have to revise the standard layoff-recall practices that have been used to adjust output for demand; and
- new technologies may bring massive changes in the man/machine interface, implying changes in managerial skills as well.

Training supervisors in textiles and apparel has always centered on developing the ability to manage substantial numbers of low-skilled workers, while the factories of the future are likely to demand supervisors who manage fewer people performing more highly skilled functions. If the current labor or supervisory force cannot make the transition to the new system, the industry may need substantial restaffing. The costs and time required to train more highly skilled workers and supervisors would then increase, giving larger firms an even greater advantage over more moderately sized companies.

Other industrial nations have already made plans to address these human factors aspects. The European Community has provided \$1 billion in funding for retraining of textile and apparel workers, and for wage subsidies during training. Sweden has its own \$27 million fund for retraining and relocation for displaced workers. The United Kingdom has a \$110 million fund that includes money for retraining, and Spain provides funds for early retirement of excess employees.

## **Industrial Structure<sup>30</sup>**

### **The Weaving Industry**

The U.S. weaving industry consists of hundreds of companies, both large and small, which compete in the cotton and raw fabric market. The fabrics produced by weaving firms are intermediary products, which are then sold for further fabrication.

The industry is defined by:

- nearly identical manufacturing technology and machinery,
- easy substitutability of products,
- similar channels of distribution, and
- high expenditures for new plant and equipment.

Companies in the weaving industry are horizontally and vertically integrated in different degrees. Production of fabrics is done both at large- and small-scale locations, resulting in different degrees of flexibility. The ability to move between large-scale production and flexibility is the key to success in the weaving industry. Fabric production for some producers is only a small percentage of their total production, whereas it is the only product for others.

The industry has frequently been revived by the introduction of new weaving technology. The newest technologies for shuttleless looms, for example, have significantly increased productivity. Clear signs for the rejuvenation of weaving have been the more than doubling of fabric exports, and substantial increases in output per employee.

Capital expenditures are concentrated mostly in large-scale production facilities. The concentration of the four largest companies, which is currently around 40 percent, is likely to increase; these companies benefit from enormous economies of scale. Nonetheless, the total number of companies has also risen slightly in recent years, primarily due to a combination of low entry barriers and the potential for higher earnings.

Technology is largely supplied by several foreign machinery producers. The development of machinery is a high-technology matter in the hands of a few companies, which compete in an almost oligopolistic market. The frequent updating of technologies

that substantially improve productivity requires high expenditures.

The profitability of the weaving industry is largely determined by:

- high degree of rivalry among corporations,
- increasing degree of substitutability, of the different textile fabric types,
- low bargaining power of these corporations against their suppliers,
- high price competition among the producers, and
- low barriers of entry and exit.

The rivalry among fabric producers is high. There are about 200 companies in the cotton weaving industry, and about 250 companies in the manmade fiber weaving industry. All fight for market shares in a low growth market, where expanding market share for one firm means decreasing shares for the others. Fabric producers face the additional problem of being cost-efficient in large-scale plants, but of losing production flexibility if they grow too large. With more than 1,000 different fabrics in demand, flexibility within a single firm is difficult to achieve. Fabrics, both woven and nonwoven, are highly substitutable.

Competition in the weaving industry is a question of price. The more vertically integrated firms have a slight advantage, in that they can add the margin at the textile end-product stage. Cost advantages can also be achieved by higher productivity through improved use of technology.

The suppliers of the fiber industries have the potential to enter the weaving industry with relative ease. In addition, larger weaving firms frequently integrate backwards, since entry barriers are merely a function of the high capital requirements for machinery. The skills required for the operation of a weaving plant are not too demanding.

### **The Circular and Warp Knit Industries**

The circular and warp knit industries are essentially fabric forming industries. While they have similar technologies, they generally compete in independent markets—the former in the fabric market for apparel goods, and the latter in the home furnishings market. Warp knit is also used in some underwear. Industry competition resembles that of the weaving industry.

<sup>30</sup>This discussion is based largely on "Technologies for the Textile and Apparel Manufacture in the U S," *op. cit.*, pp. 146-173,

The circular knit sector currently benefits from productive machinery with computer control and high future prospects of more automation. The warp knit sector, on the other hand, uses complex technology that does not change rapidly. Eastern European countries are the leading producers of this machinery.

The circular knit industry is currently consolidating. In recent years, the number of companies has declined from over 600 to under 500. The number of employees has also declined. In contrast, the warp knit industry is fragmenting, with an increasing number of firms. Improvements in this industry are focused on production, not marketing.

Profitability in both sectors is depressed, mainly because of import competition. The U.S. industry has no productive advantages. Labor costs, even though the industry is capital-intensive, are the crucial factor in competition. Many experts believe that prospects for the industries are dim. Technological advances do not tend to improve financial performance, and imports significantly threaten existing markets.

### **The Tufting Industry**

The tufting industry produces carpets, a highly standardized product guided by standardized technologies. The U.S. industry consists of several hundred large-scale corporations. The industry is defined by a unique manufacturing technology, well-defined markets, and high capital intensity. Tufting technology has reduced the production costs of carpets significantly, and has created entirely new markets in home furnishings. Most tufting companies are independent from textile companies; however, many of the large integrated textile companies have tufting operations as well.

The industry is not highly concentrated, but is growing rapidly. Fiber producers, who play a critical role already, will probably become even more important as industry growth slows. Improvements are needed in both marketing and production, since tufting is largely an export industry; quality and cost advantages over foreign competitors can be increased by extensive R&D from fiber producers.

The profitability of the tufting industry is largely determined by:

- the increasing degree of rivalry among the corporations,

- the innovative capacity of fiber companies,
- the relatively high bargaining power of these corporations against their suppliers, and
- high barriers of entry.

One can, nonetheless, expect substantial numbers of entries into the industry. Entry barriers are becoming lower, while exit barriers remain low.

The tufting industry's supplier firms enjoy a particularly large potential to enter this sector. Industry suppliers consist of large fiber producers that develop special fibers for carpet producers. These fiber suppliers compete heavily on a price basis. Still, the relative bargaining power of the tufting industry with its suppliers is high, and its companies are largely in control of the pricing process.

Rivalry among tufting companies is moderate but increasing. There are 300 to 400 similar sized companies competing. High growth rates have enabled these companies to compete comfortably, without problems of overcapacity. High standardization of both the production process and the product have made it difficult to be distinctive. A substantial experience curve exists, promoting relatively large scales of production. Competition is increasingly forcing a cost emphasis in the struggle for market share.

Technology for tufting is largely supplied by a few machinery producers. The technology is relatively simple, highly standardized, and does not require substantial reinvestment. The units of production are relatively small, and require about one normal-sized room.

Tufting is an emerging industry in a transitional phase, with the corresponding structure of high exports, increasing competition, and a decreasing experience advantage. Prospects for the tufting industry are good. The industry is fragmenting, due to negative returns to scale. As market segments become more differentiated, fiber producers are likely to play an even more essential role in new developments.

### **Other Nonwoven industries**

The U.S. nonwoven industry consists of a rapidly growing number of small-scale firms, which compete in a wide variety of different markets with hundreds of different products. Some of these small firms are owned by large corporations. The industry is characterized by:

- diversity of manufacturing processes,
- easy substitutability of certain products,
- diversity of markets, and
- high expenditures for R&D.

Companies are horizontally and vertically integrated to differing degrees. The nonwoven sector is a small percentage of total production for some producers; for others, it is their entire production. Because of nonwoven fabrication processes, it is sometimes difficult to include this sector within the traditional textile industry complex. However, the industry also exemplifies the tremendous possibilities of a future textile industry. Experts suggest that the textile industry would be well advised not to miss these opportunities, a large share of which may be captured by industries like paper and chemicals.

Profitability is largely determined by several factors, including:

- the high degree of rivalry among competitive products,
- high degree of substitutability of different nonwoven structures,
- relatively high bargaining power of these corporations against their suppliers,
- wide variety of applications for the products, and
- variety of different markets.

Also, high entry barriers contrast with low exit barriers. The most important factor in profitability, however, is that the nonwoven industries are a relatively young market sector—numerous new applications are on the horizon.

Technology for the nonwoven industry is developed by some U.S. machinery manufacturers, as well as producers. The kind of technology used is an important factor in future productivity increases in the

industry; others parallel the chemical industry. Some technologies are close to those in the paper industry. One can expect that new processes will boost this industry even further. Standardization within the industry is low with respect to the technologies used, as many new products are related to the development of new machinery and manufacturing technologies.

Suppliers of the nonwoven industries are entering the industry in great numbers. One can expect that this development will afford large multinational corporations—many of which are chemical companies—an opportunity to enter the traditional textile industry. Capital expenditures for technology and R&D are high. But once the standardization of the production technology starts, already the case for certain products, entry barriers will be low, due to production machinery that is inexpensive, small, and productive. The reverse situation, backward integration, is less likely. Nonwoven producers do not have the necessary resources to integrate backwards.

The suppliers' bargaining power is strong for the nonwoven industries. One can expect their importance to increase. The buyers' bargaining power, on the other hand, is low. Most nonwoven products are quite different from one another. Competition is low, so prices can be kept high. The diversity of customers makes it easy for producers to find highly profitable market niches. Furthermore, demanded quantities are large. One example is geotextiles, used in landscaping.

Nonwoven products are highly substitutable. Nonwovens compete with both textile products and products from the paper industries. It is likely that these products will experience cost reduction and quality improvement as a result.

## END USES OF TEXTILES

Textile mill products have three major end uses—apparel, home furnishings, and industrial and specialty products. Historically, apparel has dominated consumption. But this is no longer the case. While there are cyclical variations, the other two uses have been growing in importance; apparel's share of fiber consumption remained at approximately 37 per-

cent between 1979 and 1985, whereas the share of home furnishings grew from 31 to 38 percent. Industrial textile products still consume over 20 percent of fiber production.<sup>31</sup>

<sup>31</sup>*Textile Organon*, vol 57, No. 9, September 1986, p. 204



## **Industrial Structure**

### **Traditional Apparel**

The traditional apparel industries, dominated by the clothing industries, account for nearly half of all textile and apparel sales. In 1985, U.S. consumers spent \$133 billion on apparel, or nearly 5 percent of total disposable personal income.<sup>32</sup> Production includes the manufacture of men's, boys', women's, girls', children's, and infants' apparel and apparel accessories, excluding footwear. Apparel and apparel accessories are chiefly made by cutting and sewing woven and knit textile fabrics, or by knitting from yarn. Some items are made by cutting, sewing, cementing, or fusing such materials as rubberized fabrics, plastics, and leather.

Unlike much of the rest of the industry, where significant numbers of small- and medium-size businesses are giving way to vertical integration, apparel remains an industry segment dominated by small manufacturers, jobbers, and contractors. Manufacturers perform the entire range of operations of garment making. Jobbers are responsible for their own designs, acquire the necessary fabric and related materials, and arrange for sale; however, they contract out most production operations, with the exception of cutting. Contractors receive already-cut garment part-bundles from jobbers, and process them into finished garments.

The apparel industry is characterized by:

- many small firms,
- ease of entry,
- threat of failure, and
- individual firms acting as price-takers, with respect to supplying firms and retail channels of distribution.

The industry comes close to textbook conditions for "perfect competition," but, ironically, what keeps shops so small is in part the specialization that each has in a particular narrow product line.

Manufacturers can readily expand and contract output through the use of jobbers and contractors, which reduces reliance on heavy capital investment for expansion or the cost of unused capacity for contraction. Indeed, jobbing and contracting are growing, relative to manufacturing (see table 5). In women's

outerwear, for example, while there were 35 percent fewer manufacturers between 1977 to 1982, the number of contractors and jobbers increased by 26 and 52 percent, respectively. Apparel contractors contribute approximately \$3 billion of the value added to apparel products each year.<sup>33</sup>

Labor-intensive operations still predominate in the industry, and wage costs have become one of the critical factors in competition. Apparel is one of the largest employers of women and minorities. People from small towns with few alternatives, the undereducated, and immigrants are widely employed in the industry, providing a low wage, exploitable labor force. In fact, this system—a mechanism for shifting production from one area to another, in quest of labor cost advantage—is a source of employment for the "hard-to-employ," especially for undocumented immigrants.

According to a study by the International Ladies' Garment Workers' Union (ILGWU), the current expansion of the contracting system means that:

... sub-minimum wages, overtime and child labor violations, and illegal homework are once again commonplace in the apparel industry.<sup>34</sup>

In fact, there is evidence of the growth of a number of "underground" apparel operations which, according to some calculations, comprise up to 35 percent of garment production in unregulated shops and illegal operations.<sup>35</sup>

As of 1982, there were 16,655 companies operating 18,233 establishments in apparel manufacturing—this excludes knitwear, which is categorized as part of textile mill products by standard industrial classification (SIC), as well as part of such other assorted manufacturing categories as rubber and plastic clothing, surgical corsets, and feathers (see table 6 for branch categories of the apparel sector). Including these other manufacturers brings the number of companies to just over 19,000, and the num-

<sup>33</sup>George Wine, American Textile Manufacturers Institute, personal communication.

<sup>34</sup>International Ladies' Garment Workers' Union, Research Department, "The US. Apparel Industry, 1960-1985, With Special Emphasis on Women's and Children's Apparel," Oct. 18, 1985, p. 10.

<sup>35</sup>Letter to OTA of Apr. 20, 1986, from Dr. M. Patricia Fernandez-Kelley, Department of Geography and Environmental Engineering, The Johns Hopkins University, p. 3.

<sup>36</sup>U.S. Department of commerce, Bureau of the Census, *1982 Census of Manufacturers*.

<sup>32</sup>*Textile Highlights*, op. cit., p. 20.

**Table 5.—Number of Establishments and Production Workers, by Type of Establishment, Women's Outerwear industries, 1963-82**

	Total	Manufacturers	Jobbers	Contractors		Total	Manufacturers	Jobbers	Contractors
<i>Industry: women and misses blouses (SIC 2331):</i>					<i>Industry: women's and misses suits and coats (SIC 2337):</i>				
All establishments					All establishments				
1963	1,175	171	157	692	1963.	2,516	573	455	1,092
1967	990	285	137	568	1967.	2,101	712	423	966
1972	971	242	163	566	1972	1,618	386	340	892
1977	1,422	424	166	832	1977	1,677	445	316	915
1982	1,955	296	369	1,288	1982	1,512	306	352	853
Production workers (000s)					Production workers (000s):				
1963	521	91	24	381	1 9 6 3	755	201	6.6	423
1967	501	132	2.8	345	1967	716	23.1	8.4	401
1972	548	141	2.9	378	1 9 7 2	649	181	55	414
1977	742	156	3.6	55.0	1 9 7 7	728	194	67	46.6
1982	794	138	7.0	58.6	1982..	632	132	8.9	411
Production workers per establishment					Production workers per establishment:				
1963	443	532	15.3	551	1963	30.0	351	145	38.7
1967	510	463	204	607	1967	341	32.4	199	41.5
1972	564	58.3	178	668	1972	401	46.9	162	46.4
1977	522	368	21.7	661	1977	434	43.6	21.2	509
1982	406	466	19.0	455	1982	418	43.1	253	482
<i>Industry: women and misses dresses (SIC 2335):</i>					<i>Industry: women and misses outerwear (not elsewhere classified) (SIC 2339):</i>				
All establishments					All establishments				
1963	4,752	970	681	2,434	1963	1,297	704	153	440
1967	5,225	1,870	713	2,642	1967	1,100	470	169	461
1972	5,567	2,364	712	2,491	1972	1,373	476	197	700
1977	6,112	3,444	449	2,219	1 9 7 7	1,802	831	189	782
1982	5,627	2,105	644	2,877	1982	1,746	450	341	955
Production workers (000s):					Production workers (000s):				
1963	1771	39.5	9.3	113.9	1963	514	250	3.6	228
1967	183.7	54.9	12.1	116.7	1967..	517	225	41	251
1972	187.0	60.5	12.4	114.2	1972	71.5	253	3.9	423
1977	1468	51.7	8.2	86.9	1977	88.3	324	6.5	493
1982	120.0	27.9	8.1	83.8	1982	93.5	29.1	87	557
Production workers per establishment,					Production workers per establishment				
1 9 6 3	373	40.7	137	468	1963	396	355	235	518
1967	352	29.4	170	442	1967	470	479	24.3	544
1972	336	256	174	458	1972	521	532	198	604
1977	240	150	183	392	1977	49.0	390	34.4	630
1982	213	133	126	29.1	1 9 8 2	536	647	255	583

SOURCE U S Department of Commerce, Bureau of the Census, *Census of Manufacturers, 1982*

ber of establishments to nearly 21,000 (see table 7). The average number of establishments per company is therefore approximately 1.1 for apparel. It is important to note that the number of companies and establishments has decreased since 1982; however, most estimates suggest that little change has occurred in the ratio between the two.

The average manufacturing shop size is quite small. As of 1982, in nearly all branches of women's apparel, the typical size of an apparel shop was less than 75 employees—basically unchanged from the 1950s. In women's dresses, the average shop size is only 21. This decentralization means that whereas industries such as drugs, petroleum refining, tires, steel, or motor vehicles account for 90 to 100 per-

cent of domestic production through the operations of their 50 largest firms, in women's apparel—which accounts for about 60 percent of total apparel sales—the 50 largest seldom make up more than half of domestic shipments. And, in contrast to other parts of the overall textile industry, government data do not show a trend toward concentration in apparel.

Domestic apparel production has grown only moderately in recent years. Using 1977 as a base year, the Apparel Products Index showed a 1984 level of 100.9; industrial production for clothing was only 95.0.<sup>37</sup> And while the volume of apparel in 1967 dol-

<sup>37</sup> Federal Reserve Board Industrial Production, statistical release, Nov 14, 1986

**Table 6.—Branches of the Apparel (Knit and Woven) Industry, by Standard Industrial Classification Code Number**

SIC code	Branch of industry
2253†	Knit outerwear mills
2254†	Knit underwear mills
2259	Knitting mills, not elsewhere classified
2311	Men's, youths', and boys' suits, coats, and overcoats
2321	Men's, youths', and boys' shirts (except work shirts), collars, and nightwear
2322	Men's, youths', and boys' underwear
2323	Men's, youths', and boys' neckwear
2327	Men's, youths', and boys' separate trousers
2328	Men's, youths', and boys' work clothing
2329	Men's, youths', and boys' clothing, not elsewhere classified
2331•	Women's, misses', and juniors' blouses, waists, and shirts
2335*	Women's, misses', and juniors' dresses
2337*	Women's, misses', and junior's suits, skirts, and coats (except for coats and raincoats)
2339*	Women's, misses', and juniors' outerwear, not elsewhere classified
2341•	Women's, misses', children's, and infants' underwear and nightwear
2342*	Corsets and allied garments
2361*	Girls', children's, and infants' dresses, blouses, waists, and shirts
2363*	Girls', children's, and infants' coats and suits
2369*	Girls', children's, and infants' outerwear, not elsewhere classified
2381†	Dress and work gloves, except knit and ail-leather
2384†	Robes and dressing gowns
2385†	Raincoats and other waterproof outer garments
2386†	Leather and sheep-lined clothing
2387†	Apparel belts
2389†	Apparel and accessories, not elsewhere classified
2395*	Pleating, decorative and novelty stitching, and tucking for the trade
2397†	Schiffli machine embroideries
3069†	Fabricated rubber products, not elsewhere classified (insofar as it includes vulcanized rubber clothing)
3079†	Miscellaneous plastic products (insofar as it includes plastic clothing)
3151†	Leather gloves and mittens
3842†	Orthopedic, prosthetic, and surgical appliances and supplies (insofar as it includes surgical corsets, belts, trusses, and similar articles)
3962*	Feathers, plumes, and artificial flowers (insofar as it includes artificial flowers)

†Branch of industry specializing in producing articles of apparel for both sexes.

•Branch of industry specializing in producing women's and children's apparel.

SOURCE U.S. Executive Off Ice of the President, Office of Management and Budget, *Standard Industrial Classification Manual*, 1972

lars rose, five other important production measures have declined (see table 8):

1. employment of production workers,
2. production hours worked,

3. volume of production in pounds,
4. volume of production in square yards, and
5. physical output in millions of dollars.

But even these discouraging production figures may overstate domestic production. Commerce Department data on domestic apparel production include garments cut in this country and sent abroad for sewing and other processing, under the provisions of Item 807 of the Tariff Schedules of the United States (see box C, ch. 5). These "807" items maybe comingled with goods fully produced in this country and reported to the Bureau of the Census as part of the quantity and value of domestic production.<sup>38</sup>

Intense competition among many small producers is reflected in a slower rise in apparel prices relative to the economy as a whole.<sup>39</sup> Between 1967 and 1984, the wholesale price of all apparel increased 101.1 percent; that of women's, misses', and juniors' apparel rose 79.1 percent; and that of girls', children's, and infants' apparel rose 102.7 percent. For all commodities, wholesale prices increased by 210.3 percent, more than twice as fast as apparel.

Competition in apparel is also demonstrated by comparatively low profit margins.<sup>40</sup> For most of the past three decades, after-tax profits for apparel firms ranged between 1 and 2 percent of total sales. In contrast to a profit ratio of 5.2 percent before taxes and 2.7 percent after taxes for all manufacturing in 1980, the parallel returns in the apparel industry were 3.9 percent before taxes and 2.0 percent after.

Because of the small size of the typical garment firm and the large size of the national apparel market, apparel firms tend to be highly specialized. Most establishments produce a single generic product, or a small number of similar products. This degree of specialization does not exist abroad, where production of a wide range of garments is more common.

<sup>38</sup>International Ladies' Garment Workers' Union, op.cit., p. 7

<sup>39</sup>Ibid., p. 12.

<sup>40</sup>Internal Revenue Service data, cited in Ibid., pp. 12-13.

**Table 7.—Number of Establishments Per Company,<sup>a</sup> Apparel (Knit and Woven) Industries, United States, 1982**

Branch of industry	Number of companies	Number of establishments	Establishments per company
Women's blouses . . . . .	1,825	1,955	1.07
Women's dresses . . . . .	5,489	5,627	1.03
Women's suits, coats, and skirts . . . . .	1,431	1,512	1.06
Women's outerwear, not elsewhere classified . . . . .	1,595	1,746	1.09
Women's and children's underwear . . . . .	477	604	1.27
Corsets and allied garments . . . . .	134	151	1.13
Children's dresses. . . . .	490	556	1.13
Children's coats. . . . .	71	81	1.14
Children's outerwear, not elsewhere classified . . . . .	279	332	1.19
Robes and dressing gowns . . . . .	128	135	1.05
Waterproof outergarments <sup>b</sup> . . . . .	98	112	1.14
Leather and sheep-lined clothing <sup>b</sup> . . . . .	186	186	1.00
Apparel belts <sup>b</sup> . . . . .	317	319	1.01
Apparel, not elsewhere classified <sup>b</sup> . . . . .	362	369	1.02
Schiffli machine embroideries . . . . .	356	366	1.03
Pleating and stitching, . . . . .	906	912	1.01
Knit outerwear . . . . .	893	923	1.03
Knit underwear. . . . .	72	84	1.17
Fabricated rubber products, not elsewhere classified . . . . .	1,213	1,380	1.14
Artificial flowers . . . . .	207	215	1.04
Men's and boys' suits and coats . . . . .	443	528	1.19
Men's dress shirts and nightwear . . . . .	535	741	1.39
Men's and boys' underwear . . . . .	61	77	1.26
Men's and boys' neckwear. . . . .	165	170	1.03
Separate trousers . . . . .	269	356	1.32
Work clothing. . . . .	305	544	1.82
Men's and boys' clothing, not elsewhere classified . . . . .	575	646	1.12
Fabric, dress, and work gloves . . . . .	78	102	1.31
Leather gloves . . . . .	80	96	1.20
Total . . . . .	19,040	20,830	

<sup>a</sup>A company is defined to include all manufacturing establishments owned by the company, plus all manufacturing establishments of subsidiaries or affiliates over which the company has acknowledged control

<sup>b</sup>This branch of industry produces items for wear by both sexes

SOURCE US Department of Commerce, Bureau of the Census, 1982 Census of Manufacturers

### Nontraditional Apparel<sup>41</sup>

While most apparel involves the cutting and joining of garments from fabric, knit items use a different technology. The knit sector of the industry is divided into two major categories: hosiery and knit underwear products, and knit outerwear products. Both are facing severe challenges from imports. Product standardization has allowed developing nations to gain quick footholds in this market segment, despite lower labor costs relative to traditional apparel. Prospects for the knitwear sector will depend not only on controlling the level of import penetration, but also on aggressive marketing of identified market niches and perhaps, especially with knit outerwear, by forward integration into retailing.

<sup>41</sup>This section is based largely on "Technologies for the Textile and Apparel Manufacture in the U.S.," op cit., p p 174-189.

### The Hosiery and Knit Underwear Industry.—

The hosiery and knit underwear industry (SICs 2251, 2252, and 2254) consists of 500 to 600 corporations—some integrated horizontally, others vertically—which compete in two separate homogeneous and undifferentiated markets, the hosiery market and the underwear market.

The hosiery and knit underwear industries are characterized by a common manufacturing technology, the circular knitting process. The products are essentially apparel goods, but with almost no sewing except for knit underwear. Labor costs are considerably lower than those for traditional apparel.

Rivalry among companies is high, due to:

- the large number of firms,
- low growth rates of the markets,
- standardization of the products, and
- diversification of the industry.

**Table 8.—Apparel Industry in the United States, Production Measures, 1967-84**

Year	(a) Production workers emplt. (thousands)	(b) manhours	(c) Volume in 1967 dollars (millions)	(d) Volume in pounds (millions)	(e) Volume in square yards (millions)	(f) Physical output (millions)	(g) Apparel Products Index (1977=100)
1967	1,268.3	2,299,812	\$15,952.2	3,615.4	N.A.	\$14,028.3	80.9
1968	1,278.3	2,347,827	17,571.2	3,745.4	N.A.	14,465.1	82.9
1969	1,277.0	2,319,972	17,817.9	3,599.7	N.A.	14,003.6	85.6
1970	1,239.1	2,220,113	18,491.1	3,585.1	N.A.	13,130.4	82.2
1971	1,210.6	2,185,677	17,430.5	3,733.4	9,934	13,231.6	83.2
1972	1,230.9	2,225,876	18,987.1	4,195.0	10,762	14,640.7	88.3
1973	1,257.4	2,267,561	19,475.3	10,244	10,244	14,431.0	89.0
1974	1,188.7	2,100,560	18,608.7	3,746.1	9,910	13,775.7	85.0
1975	1,078.2	1,900,751	18,562.5	3,697.2	9,378	13,516.7	77.6
1976	1,140.0	2,056,519	19,414.0	3,877.8	9,790	13,847.7	91.5
1977	1,130.3	2,014,759	19,579.0	4,158.1	10,497	13,664.0	100.0
1978	1,138.3	2,017,123	20,726.9	4,097.4	10,299	13,915.7	103.1
1979	1,106.1	1,952,828	21,440.5	3,990.4	10,131	13,704.3	98.3
1980	1,079.0	1,916,385	21,440.0	3,939.8	10,060	13,680.3	97.3
1981	1,060.7	1,893,119	21,625.1	3,759.7	9,924	13,747.1	96.1
1982	985.3	1,712,798	20,804.0	3,437.0	9,729	12,652.0	87.3
1983	980.6	1,776,621	21,543.9	4,015.3	10,135	13,306.4	95.3
1984	1,001.5	1,816,785	N.A.	3,772.9	10,086	N.A.	102.8

NA.—Not available

SOURCES Prepared by the International Ladies' Garment Worker's Union, from Cols. (a) & (b) data from U.S. Bureau of Labor Statistics (SIC 23-239+2251+2252+2253+2254). Col (c) dollar volume in terms of items produced in the United States as shown in the Annual Apparel Survey, Census of Manufacturers, and Annual Survey of Manufactures Col (d) U.S. Textile Economics Bureau, Inc., *Textile Organon*. Col (e) National Cotton Council of America, *Cotton Counts its Customers*. Col. (f) quantities produced in the United States, shown by the Annual Apparel Surveys, Census of Manufacturers and Annual Surveys of Manufactures weighted by average values of different products in 1967 taken from the same sources Col (g) Index of Production for Apparel Products, compiled by the Federal Reserve Board

There are many similarly sized companies which compete in a comparatively low growth market. High standardization of the product prevents competitors from becoming distinctively different from one another. Furthermore, as a result of all firms being on a similar experience curve, the cost structure determines prices.

The key to profitability in the hosiery and knit underwear industry appears to be eliminating the currently high level of standardization among products. It is essential to have excellent marketing programs. Also critical, at least according to some prominent experts, is higher product differentiation and marketing flexibility. While this production-oriented industry has been changing, such developments have tended to be more reactive than proactive.

Some experts see the industry as one in decline. The industry is consolidating into smaller units, and disinvestment is occurring. Technology turnover is low; productivity improvements are unlikely to come

from newer technology; and employment is decreasing, as are the number of companies in the industry. Nonetheless, some parts of the industry are showing export strength, suggesting that the low profitability in the industry is due largely to missed marketing and innovation opportunities, and not just to industry structure. Much of the export boost is due to innovations of the fiber companies in new fibers and related products. In summary, the hosiery and knit underwear industry, while currently declining, could be revived with proactive marketing.

Technology for the industry is largely supplied by a few machinery producers, of which only a small percentage are U.S.-owned. Updating of machinery is fairly frequent, making the technology used an important factor in the competition.

**The Knitting Outerwear Industry.—The knitting outerwear industry (SIC 2253) consists of several hundred small-scale but growing operations. These companies compete in several different mar-**

kets, including sweaters, shirts, and general outerwear. While such markets are interrelated, there is much potential for segmentation. The industry is largely part of the apparel industry, but only a small percentage of the production technology involves sewing.

Rivalry among fiber producers is high, due to:

- the large number of firms in the industry,
- the variable size of industry firms,
- low growth rate of the markets,
- high imports,
- high amount of fixed costs,
- standardization of the products produced by U.S. manufacturers, and
- general industry diversification.

Gaining market share in this sector is extremely difficult. The unnecessarily high degree of standardization of apparel products in U.S. markets provides an opportunity for some manufacturers to create strong market niches for knitting outerwear products. But even though manufacturers could substantially differentiate their products, few have done so. In addition, the industry faces extremely high import levels from more flexible firms, which often have higher quality products.

Buyer bargaining power is substantial. Products are competitive, and those of the buyer industry, retailers, are high. Due to the large amount of competition, substitutability among domestic and foreign knitting producers by retailers is relatively easy.

The knitting industry has the potential to integrate forward. The lack of profitability in this sector could be made up for by an appropriate retail chain. Italian outerwear knitters, for example, have successfully opened a retail chain in the United States. This should be possible for U.S. producers as well, since there are no substantial entry and exit barriers in the industry.

Low entry barriers are a function of:

- low economies of scale,
- low product differentiation,
- marginal cost advantages,
- moderate capital requirements, and
- access to the distribution channels.

Low economies of scale provide a good incentive for small and flexible units to enter the industry, if

they have access to distribution channels. Disadvantages to firms that lack vertical integration can easily be compensated for through marketing flexibility and better product mix. The industry has a high potential for profits if firms react to consumer demand, if they forward integrate, and if they adopt innovative marketing techniques.

The technology used in this sector is basically mature, and is supplied largely by a few machinery producers—of which only a small percentage are U.S.-owned. Updating of machinery is moderate in the knitting sector, and low in sewing operations. No single competitor has distinctively different technology.

### ***Pending Technology***

#### **Cutting Technologies**

Most experts agree that the making of markers by computer-controlled systems, as well as the cutting of fabrics under computer control, is a likely development for some aspects of apparel production. And a number of desirable advances in the actual spreading and cutting of fabrics can be envisioned.

Spreading, unlike most other apparel technology, has not changed much in recent years. More important, however, is the question of whether cutting multiple layers of fabric to form bundles will be either replaced or augmented by continuous cutting of fabric, one layer at a time. The current bundle system acts as a buffer between various process steps, creating a reservoir to absorb or augment the flow of material through a system of processes. The bundle system is also directly responsible for the long in-process time that is characteristic of today's apparel processes. Replacing a process that requires a garment to spend anywhere from 2 to 20 days in the manufacturing chain with a process that would allow a garment to appear several hours after cutting makes for an attractive alternative.

The reciprocating knife is thought by many to be the weak link in modern cutting systems; otherwise, current computer-controlled systems are generally adequate. Depending on one's view, what is needed is the ability either to cut more plies more reliably, or to cut single layers quickly with immediate transfer to assembly stations. Reciprocating knives are limited in speed and flexibility, while jet cutters can



Photo credit: Charles Gardner, School of Textiles, North Carolina State University

The new computer-controlled apparel laser cutting technologies (left) represent a major advance over hand cutting (right).

suffer severe energy losses if too many layers are presented to them. Laser cutters tend to fuse fabrics that are cut in more than one layer. An ideal cutting system could first be defined by whether multiple plies or individual layers were being cut. In addition, an ideal system could:

- apply to all fabric types,
- have a circular cross-section of minimum diameter,
- operate in conjunction with a computer-controlled guidance system, and
- be able to enter the fabric at the center as well as at the edges.

Materials utilization is of major concern. The amount of waste in cutting can vary from as little as 8 percent for well-placed, computer-generated markers on unpatterned material, to as high as 25 percent for patterned fabrics. Since the fabric cost is roughly one-third to one-half the garment cost, this represents a major loss. Any technological development that could reduce either the waste level or the actual cost of the fabric waste would be of



Photo credit: Copyright (©) 1986, 1987 by Bobbin International Inc. All rights reserved

great interest. Areas needing investigation include the packing of patterns with maximum efficiency, the optimization of seams and their associated seam allowances, and the relationship between cutting techniques and waste generation. Other ideas include the building up of garments or garment subassemblies directly from fiber, in order to ensure generation of zero waste.

As cutting technology automates—and as fabric quality continues to improve, making apparel manufacturers increasingly willing to accept fabric without their own quality inspection—some predict that a new degree of vertical integration will emerge, with certain elements of cutting becoming part of textile mill manufacturing.<sup>42</sup>

### Joining Technologies

Today, sewing contributes the largest portion of the labor cost to an apparel item, even though as much as 70 to 80 percent of what is ascribed to sewing cost is really materials handling. According to some experts, automation of materials handling, both before and after the sewing machine, poses the greatest potential for successful automation.

It is a widely held view that sewn seams will never be totally replaced. They have both mechanical and aesthetic attributes that are essential in some parts of garments. On the other hand, many have the view that alternatives to sewing can and should be inves-

<sup>42</sup>George Wine, personnel communication.

tigated closely. These alternate technologies would be in the general areas of glueing, fusing, and welding of fabrics. It also seems likely that some of these techniques could be automated more successfully than sewing. There may also be use for these techniques as temporary joints, prior to a final joining by sewing techniques.

### Technologies for Apparel Assembly

The apparel sector is characterized by relatively simple technology and a high degree of labor intensity. In the global marketplace of apparel, most experts see a reduction in import penetration and increased automation as the only long-term solutions for the survival of apparel production in industrialized nations. Automation is considered the solution for reducing labor costs, adding production flexibility, and standardizing quality. In addition, there are many new uses for apparel, ranging from space suits to disposable apparel for medical use, and from protective suits for chemical plant employees to lightweight, bullet-proof vests for protecting soldiers and police officers.

Today's basic piece of equipment, the sewing machine, is fundamentally a mechanized tool. It has remained substantially the same throughout the century. This is due primarily to the small and specialized nature of individual establishments, and to the ever-changing styles and fabrics of the fashion market.

Simple technologies with low fixed assets per employee,<sup>43</sup> coupled with management and manufacturing flexibility provided by the contracting system, mean easy entry and exit from the industry and a highly competitive economic environment. Competition is not confined to producers manufacturing the same types of products, but extends to firms that produce substitutes. Firms making dresses, therefore, compete with those manufacturing skirts, blouses, sweaters, suits, slacks, and a variety of other products. Such competition results in a high rate of turnover, with hundreds of apparel firms going out of business each year.

Clearly, the potential for improving productivity in the apparel industry through new technological

<sup>43</sup>According to 1981 data from the Census Bureau, the apparel industry (as represented by SIC 23) had average fixed assets per employee of only \$40,000, in contrast to an average of \$31,100 for all manufacturing

developments and adaptations is substantial. Where production is sufficiently large in volume, more advanced technologies are being used. This is especially true in fabric spreading and cutting, and in specialized stitching operations.

Most sewing technologies remain homogeneous, and are largely worker-paced rather than automatic. Some new systems for automated sewing are in development, such as the sewing of sleeves for men's suits developed through the tripartite support of government, industry, and organized labor. One such effort, organized as the Textile/Clothing Technology Corp. ((TC)<sup>3</sup>), spearheads the U.S. effort in automated sewing. (TC)<sup>3</sup> has succeeded in automating the production of sleeves for men's suits, significantly reducing the time it takes to manufacture each of 20 million sleeves per year.

During the past decade, research in apparel manufacturing has expanded from the mechanical engineering base to microelectronics applications and a "total systems" concept. Information processing has become highly advanced and lower in cost. This is especially germane to apparel manufacturing, where the number of different bits of information needed to cut, route, and assemble the components of many different styles and sizes of garments reaches enormous proportions. Without relatively inexpensive computers with high memory capacities, it is impractical to automate apparel manufacturing processes.<sup>44</sup>

The development of automated pattern-making and cutting equipment, which replaces operations formerly done by hand, has become technologically feasible since the advent of sufficiently powerful yet relatively inexpensive information processing of microelectronic capabilities. Many apparel firms have already installed computer-assisted pattern making, marking, and cutting systems. Automatic sewing machines are used in some locations, and automatic conveyor systems for handling in-process goods are in evidence in many apparel plants.

The next critical step in apparel automation has been the development of technologies that can identify and pick up a single ply of fabric from a multiply lay, position the piece, and join it to another. Such advances, another result of the efforts of (TC)<sup>3</sup>,

<sup>44</sup>Gordon Berkstresser and Kazuo Takeuchi. "Automation A Fighting Chance?" *Bobbin Magazine*, March 1985, p. 50





Photo credit Copyright (©) 1986, 1987 by Bobbin International Inc.  
All rights reserved

Graders at H.L. Miller and Son are using the Gerber AM-5 system to remake new patterns out of old patterns stored in the system. What used to take 1 hour when done manually now takes less than 2 minutes.

has been transferred to the Singer Sewing Co., which plans to begin commercial use in late 1987. This innovation, of course, depends on robots that have more than limited decision making and movement flexibility capacities, such as those that exist in current industrial robotics.

Another promising technological development in apparel, currently being worked on at Japan's Research Institute for Polymers & Textiles, is the application of computer graphics to apparel design.<sup>45</sup> Other developments are ready for marketing. Toray of Japan is ready to market a low-cost, microcomputer-controlled, pattern-making system this year. The Nagano Prefectural Research Institute for Information Technology in Japan has developed sophisticated software for microcomputer-controlled evaluation of fabric.

In the early 1980s, the Japanese Government provided \$60 million to a special apparel research group. The overall objective of this group has been the development of a system to administer and control the total manufacturing process and to reduce production time by 50 percent, with a pilot plant operating by 1989. Although the project has encountered some difficulty in fulfilling its goal of simultaneously addressing problems faced by both large and small businesses, several of its programs—especially those that

target large-scale production—are proceeding vigorously. The group's four specific objectives are:

1. To develop pre-sewing technology, including evaluation of the fabric, material stabilization technology, pattern making and cutting, automatic spreading, and inspection for fabric defects.
2. To automate sewing and assembly of parts, including the development of machines to fold, cut, and bind temporarily; of programmable and automatic sewing machines; and of devices for automatic pressing on forms. Also to be explored is the development of innovative methods of joining garment sections without the use of conventional sewing techniques.
3. To improve materials handling, including creating devices to hold material similar to human fingers and arms, which can transfer garment parts to precise locations; can assemble component parts into segments to be sewn together, such as collars with interlinings; and can transfer parts from one process to the next.
4. To implement a control system with the technology to integrate the production line, especially when types of products are changed, such as the flexible manufacturing system (FMS) concept; to monitor the production line, and repair or replace damaged machine parts automatically; to detect, remove, and replace defects in the goods in process; to establish a method of marking the fabric parts with sewing control information; and to develop devices to read control information during the production process.

A highly automated and flexible apparel manufacturing system will have a profound effect on the distribution system, as will the introduction of sophisticated microelectronic devices in retail stores for customer sizing and selection. This process will require the development of a more sensitive and sophisticated marketing orientation. In other words, the apparel industry must get "closer to the consumer."

If there is to be a technological revolution in apparel, a substantial adjustment by the apparel labor force may be required of both production workers and managers. Unemployment among apparel workers is likely to grow; plans to minimize dislocation could be made now, rather than later. Aside from changes in the numbers and types of production workers, there will be new demands on managers.

<sup>45</sup>Ibid., p. 52

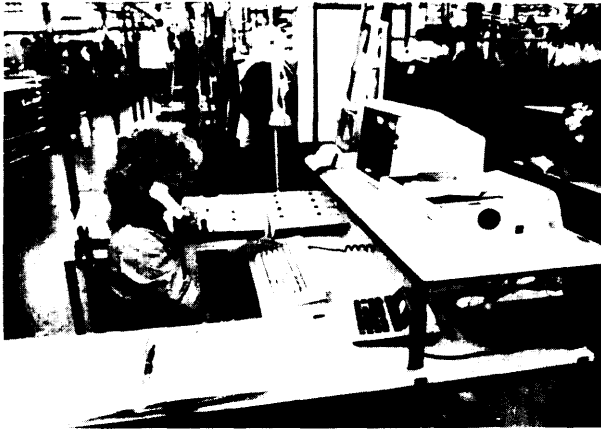

Photo credit: Copyright (©) 1986, 1987 by Bobbin International Inc.  
All rights reserved

This supervisor of a "unit production" system (see ch. 2) monitors a number of workers, parts, and production speeds simultaneously, through the use of advanced computer technologies. The skill level needed by such a manager is clearly different than that needed by the traditional supervisor in a nonautomated apparel facility.

Skills necessary to supervise large numbers of workers using simple machines with repetitive tasks are distinct from skills necessary to supervise automated lines with automated control systems and a few highly trained technicians. Management could also plan for orderly change within its own ranks.

**Pending Automation in Apparel.**<sup>46</sup>—The apparel industry of the industrialized world seems unable, with current technologies, to retain markets. Differences in labor costs are so great that even with the higher cost of long distance shipping, low labor cost countries often have a substantial price advantage. According to many experts, once the surge of imports can be slowed, the best long-term solution for the survival of the apparel industry in industrialized nations is increased automation—which will reduce labor costs, add flexibility, and standardize quality.

Research projects now under way in the United States, Europe, and Japan are demonstrating the technical feasibility of automating apparel production processes. Using computers, development of three-dimensional graphics capability for apparel de-

sign has been achieved by the Japanese Research Institution for Polymers and Textiles. The introduction of microprocessor-controlled machine functions can change the sewing operation in fundamental ways, as demonstrated by the "FIGARMA" system developed at the Chalmers University of Technology in Sweden. "FIGARMA," or Fully Integrated Garment Manufacture, is an extension of the concept of flexible manufacturing systems. FIGARMA not only points out critical areas for the development of specific new technologies, but is also a total systems approach that goes beyond technological development and into management areas, such as building computer models for processes needed in planning.

Chalmers, a Swedish company, has a history of apparel technology development. In addition to the FIGARMA approach, this firm is using an Eton overhead rack materials handling unit in its apparel laboratory to conduct research on how computers might be able to position pieces to be sewn together at two sewing stations. Some years ago, Chalmers developed an air-jet, single-ply separator. As in so many cases of this type, however, there was no short-term commercial payback for industry, so the prototype has gathered dust in the laboratory.

(TC)<sup>2</sup>, the tripartite endeavor of industry, labor, and the U.S. Government, housed at the Massachusetts Institute of Technology's Charles Stark Draper Laboratory, has made major strides in modernizing the production of men's tailored clothing. Figure 14 provides a model of this technology, which:

... has developed a computerized production process with robots which will take cut fabric and fully automate the manufacture of subassemblies. The cut fabric will be automatically fed into a machine and, with a computer-aided vision system and robot, will sew, turn, and fold the fabric. The conversion of limp fabric into sewn parts of garments, with the use of computers and robots, represents a major technological breakthrough. Until this development, the use of robots in the production process was essentially limited to rigid materials such as metals.<sup>47</sup>

Having proven success in workable technology for sleeves, coat backs, and trousers, Draper Labora-

<sup>46</sup>This section is based largely on Gordon Berkstresser, Peyton B. Hudson, and Kayuo Takeuchi, "Automated Apparel Manufacturing: A Global Perspective," cited in "Technologies for the Textile and Apparel Manufacture in the U.S.," op cit

<sup>47</sup>Statement of Murray H. Finley, President of the Amalgamated Clothing and Textile Workers' Union, AFL-CIO, to the Subcommittee on Commerce, Justice, and State, the Judiciary and Related Agencies, Committee on Appropriations, U.S. House of Representatives, Mar. 3, 1986, p. 4.

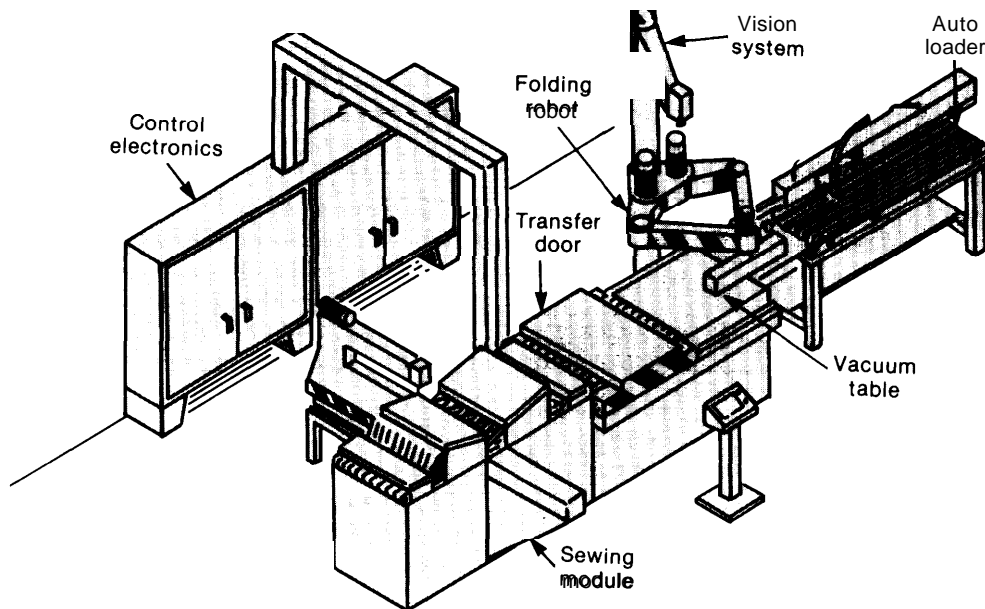
Figure 14.—(TC)<sup>2</sup> Automated Sewing System

SOURCE: *Bobbin Magazine*, September 1986.

tories are beginning a new activity to apply the technology to knitwear—permitting automatic sewing of knit parts.<sup>48</sup> Production of jacket sleeves was to be the first effort and would be used initially by Palm Beach, Inc. of Cincinnati at their Knoxville, TN, plant, and by the Hartmarx Corp. Future development of a machine to sew trousers may be initially tried by Greif Companies, a division of Genesco, for its Allentown, PA, plant. The plan is to contract with a U.S. machinery manufacturer to commercialize the technology. And the Singer Sewing Co. has placed into production a functional prototype of the (TC)<sup>2</sup> technology; Singer finds “the presence of a significant market in the near term for application of automated sewing systems.”<sup>49</sup> As for the future, Singer’s vice president of industrial products has stated that “we are only scratching the surface in terms of utilizing the technology.”<sup>50</sup>

According to Amalgamated Clothing and Textile Workers’ Union (ACTWU) President Murray Finley, the payback from technologies being developed today is rapid and substantial. Production time and

labor costs can be reduced. The inventory of fabric, in the form of bundles of sewn parts awaiting the next stages of manufacture, is greatly reduced as well.

Industry and organized labor are providing approximately \$5 million per year for these and similar efforts, and the Federal Government has pledged an additional \$3 million. With hundreds of thousands of jobs and tens of millions of production dollars at stake, the amount could be far greater; Japan is spending \$80 million to develop a fully automated apparel process for the 21st century, one which dwarfs anything on the drawing boards in the United States. The Japanese plan to develop a system in which a salesman in a clothing store would take a hologram of a customer’s body, and digitally controlled machines would then tailor-make an article of clothing.<sup>51</sup> As this goal makes clear, the difference between the United States and Japan lies both in levels of funding and in mandate. While (TC)<sup>2</sup> is an effort to automate the production of sewing, the Japanese program represents state-led industrial restructuring.

<sup>48</sup>1 bid., p. 5.

<sup>49</sup>Frank Bray and Vince Vento, “Chapter Two Begins With Singer,” *Bobbin Magazine*, September 1986, p. 170.

<sup>50</sup>1 bid., p. 174.

<sup>51</sup>Bruce Stokes, “Getting Competitive,” *National Journal*, June 7, 1986, p. 1363.

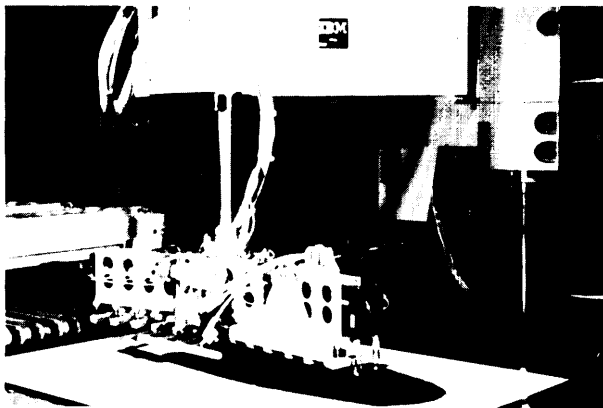
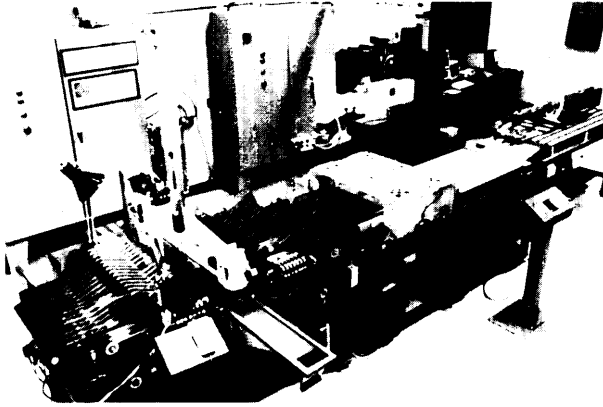

Photo credit Copyright (©) 1986, 1987 by Bobbin International Inc.  
All rights reserved

Pictured above is the factory prototype machine of (TC)<sup>2</sup>, the apparel manufacturing technology developed at MIT's Charles Starke Draper Laboratories. Below are two parts of the (TC)<sup>2</sup> manufacturing process: the "interlocking belt system," shown with the interlocked open (middle), which guides the fabric along the surface during production; and the "end effector" (bottom), which is a high-technology sewing head mounted on a standard robot.

New automated design techniques have also been developed. Designers can electronically "sketch" design, color, and texture onto a computer screen. The design variety is nearly infinite, and multiple possibilities can be reviewed in moments.<sup>52</sup>

Computer-controlled, high speed sewing machines do exist today. However, most experts feel that these machines may be inadequate for the technology of 5 years from now. Some of the areas in which sewing machine architecture and operation could be investigated include: the possibility of three-dimensional sewing rather than flat sewing; independent computer control of both the bobbin and the needle, to allow greater flexibility; and technologies that move the sewing head to the fabric instead of vice versa. This last technique is a major component of the technology developed at the Draper Laboratories by (TC)<sup>2</sup>. It also is suggested that inspection of the sewing machine could be of considerable advantage, and might possibly be integrated with the sewing process itself.

<sup>52</sup>Textile Highlights, op. cit

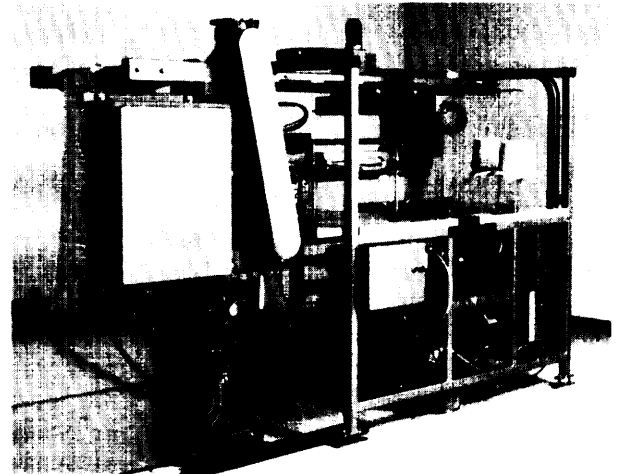

Photo credit Copyright (©) 1986, 1987 by Bobbin International Inc.  
All rights reserved

In addition to apparel production, the Singer Sewing Co. has brought robotics into the manufacture of such end-uses as washcloths (above) and upholstery.

## TEXTILE MACHINERY MANUFACTURE

### Background

The textile machinery segment of the industry is the smallest of the four. It has approximately 640 plants, employing 18,300 people—12,200 in production—in 1985.<sup>53</sup> While the U.S. textile industry represents the largest single textile machinery market in the world, U.S. machinery manufacturers are losing this market to foreign manufacturers. Whereas U.S. textile machinery manufacturers in 1960 supplied 93 percent of the domestic market, by 1979 the figure had dropped to 55 percent; much of the 1979 sales were in parts, rather than in new, complete machines. By 1982, domestic suppliers held only 48 percent of the market.

Of the \$1.6 billion spent by the U.S. textile industry in 1981, only half was being spent within the United States; that portion was largely for parts, materials handling equipment, and less sophisticated machinery. Only about one-quarter of U.S. textile machinery manufacturing firms even make complete machines.<sup>54</sup> The other half of the \$1.6 billion, which was spent for high-technology textile systems, went primarily to West Germany, Switzerland, Italy, France, Japan, and Great Britain. The United States, however, continues to be a major producer of dyeing and finishing equipment, and also exports a considerable amount of high- and low-technology textile equipment, equal to 16 percent of total production.

The U.S. textile machinery sector (SIC 3552) is losing ground in other areas as well—not only in the \$1.6 billion annual U.S. market, but also in the \$7.1 billion world market. World market share for U.S. manufacturers during that same period fell to well under 10 percent.<sup>55</sup> The United States is no longer a leader in the textile machinery market. Rather, it has become a large market for the textile machinery of overseas competitors.

Indeed, spare parts represent a disturbingly large fraction of all sales of U.S. textile machinery firms. Spare parts are only 27 percent of Italy's international sales, 49 percent of West Germany's, and 51 percent of Great Britain's—they are 92 percent of the sales of U.S. producers.<sup>56</sup> As for exports, nearly all U.S. overseas sales of textile machinery are spare parts for previously purchased equipment. This points to past U.S. machinery success, but bodes ill for current and near-future markets—especially for complete machines. U.S. technology is furthest behind the state-of-the-art in projectile and jet shuttleless weaving, open-end spinning, high-speed winding, and knitting equipment.<sup>57</sup>

Most U.S. imports of textile machinery come from Japan and the European Economic Community (EEC), and are concentrated in the fabric and yarn industries. West Germany and Switzerland together account for two-fifths of the world exports in textile machinery, while Czechoslovakia and Japan have emerged as important competitors.

Concentration in the industry is high, and is growing through an increasing number of mergers, acquisitions, and joint ventures. The Swiss-based Sulzer Corp. recently acquired Ruti, its strongest competitor; Sulzer-Ruti has close ties with both Toyoda, the Japanese leader in looms, and British air-jet technology. This enables Sulzer-Ruti to lead technological developments in an oligopolistic manner. Also to be contended with are Hollingsworth-Hergeth, Reiter-Scragg, and Barber-Colman-Warner & Swasey. While such concentration is likely to have a negative impact on competition, the R&D departments of these combined market forces is expected to advance the development of new technology dramatically.

Multinationals are beginning to dominate textile machinery manufacturing. Similar to chemical fiber manufacturers, these global corporations are highly concentrated on national and international levels. In Switzerland, for example, machinery production for the three major processing stages is dominated by Rieter, Saurer, Dubied, and Sulzer-Ruti, four giants in spinning, weaving, and knitting; in Britain,

<sup>53</sup>U.S. Department of Labor, Bureau of Labor Statistics, *Employment and Earnings*, March 1986, p. 46.

<sup>54</sup>*U.S. Industrial Outlook, 1982*, op. cit., p. 205.

<sup>55</sup>U.S. Department of Commerce, "Opportunities and Strategies for U.S. Textile Machinery Manufacturers to Improve Their Competitive Positions in Domestic and Foreign Textile Markets, 1980-1985," September 1980, p. I-33.

<sup>56</sup>*Ibid.*, p. 1-47.

<sup>57</sup>American Textile Machinery Association, *Textile Machinery Statistics*, October 1981, p. 6.

by Platt-Saco-Lowell and Bentley; in the United States, by Platt-Saco-Lowell; in Japan, by Toyota, Howa, and a division of Nissan, the automobile corporation; in Czechoslovakia, by Investa; in Spain, by Jumberca; in West Germany, by Shubert & Salzer, Sulzer, Zinser, Mayer, Schlafhorst, and Stoll and Terrot; in France, by SACM and ARCT; and in Belgium, by Picanol.<sup>58</sup> The “big eight,” ranked by estimated market shares, are Sulzer-Ruti, Rieter, Investa, Platt-Saco-Lowell, Nissan, Toyota, Schlafhorst, and ARCT. Sulzer-Ruti alone has staked out approximately one-fifth of the global market for shuttleless looms, either directly or through licensing.

There are specific market niches, however, for smaller companies. The Swiss company Maschinenfabrik Jacob Muller AG, a subsidiary of Frick, is a world leader in high-speed narrow fabric looms. Germany’s Karl Mayer Textilmaschinenfabrik claims to have 85 percent of the world market for Raschel and tricot knitting machines. While Schlafhorst is a major producer overall, it is also the acknowledged leader in the narrower markets of warping machinery and various automatic and non-automatic winders. Capitalizing on similar market niche opportunities may be one of the most critical strategies for the U.S. industry of the future.

The licensing of technology is a major method for capturing market share. Czech licenses for weaving machines, for example, have been granted to Enshu, Nissan, Toyo Menka, Draper, Crompton, Knowles, and Mayer. And although market positions stem largely from more R&D investment, most U.S. machinery producers lack either the means or the momentum for needed R&D.

Much of the European success is also due to service. The big foreign machinery producers have service facilities in the heart of the U.S. textile industry. Employees speak English, whereas a reciprocal approach seems to be neglected in U.S. export offices operating in non-English speaking nations. Spare parts can be flown in within a reasonable amount of time. Murata of America, a Japanese firm, has headquarters in Charlotte, North Carolina, as do Omintex of Czechoslovakia, and Toyota and Nissan of Japan. Sulzer of Switzerland, Pignone of Italy, and Hargeth of Germany have offices in Spartans-

burg, South Carolina. The British firm Platt-Saco-Lowell operates in Greenville, South Carolina. In 1980, Platt-Saco-Lowell boasted an order backlog of 9 months to a year on most of its product lines; that same year, the Sulzer Group had order intake for weaving and knitting equipment of over \$430 million—a large increase over the previous year. The joint efforts of Schubert & Salzer Machine Works with Ingolstadt of West Germany also reported record sales in 1980.

Some U.S. companies have experienced growth as well. In early 1980, for example, Automatic Material Handling announced orders of \$2.5 million to two U.S. companies for 12 Bale-O-Matics and new hoppers. Another textile manufacturer bought 21 chutes from that firm, and substantial sales were made to French companies. Leesona, Draper, and others—including many air control equipment companies—have also increased sales, both within the United States and abroad.

According to industry analysts at the U.S. Department of Commerce,<sup>59</sup> U.S. manufacturers are not expected to regain the technological advantage they once had in winding and weaving in the near future. On the other hand, they may stay competitive in support equipment and equipment used in opening through ring spinning. By the end of the 1980s, even newer versions of textile equipment are expected to increase productivity, safety, and energy conservation still further, presenting U.S. manufacturers with another difficult but important challenge. The technological and economic results from this development remain to be seen. Creation of the Textile/Clothing Technology Corp. by companies, unions, and government may breathe new life into the textile machinery sector; expansion of such R&D efforts could help significantly.

### **Industrial Structure**

The condition of textile machinery manufacturers in the United States may best be understood from a global perspective. Ernst Nef, publisher of the *International Textile Bulletin*, writes:

The American textile machinery manufacturers increasingly lose their position in . . . [both domestic and world] markets. There is no significant loom

<sup>58</sup>F. Clairmonte and J. Cavanagh, *The World in their Web, Dynamics of Textile Multinationals* (London: Zed Press, 1981), p. 226.

<sup>59</sup>*U.S. Industrial Outlook*, 1982, op. cit., p. 206.

manufacturer in production. Spinning machines are produced by Platt-Saco-Lowell. If they have no huge success with the new friction spinning machine, they will lose the whole market. The Japanese machines are better. Leeson is no longer of importance. All the rest are companies which are accustomed to the American market. Internationally, they are unimportant.

Draper and C&K used to be the world leading loom builders, whereas Saco, Lowell, and Whitin were the leaders in the spinning machinery sector. Furthermore, other leaders used to be Textile Machine Works, Reading, in knitting and Leeson in texturing and winding. Unifil, Johnson used to be the number one slashing machinery producer.<sup>60</sup>

Nevertheless, U.S. machinery manufacturers have developed new technology to rebuild old equipment, such as new cards and conversion from shuttle to shuttleless looms. Cards can be completely rebuilt, with cylinder speeds increased and setting accuracy improved. With loom conversion costing 15 to 25 percent of the price of a new loom, a company can increase its productivity up to 70 percent by converting conventional shuttle looms to air-jet looms; Leeson and Draper offer loom conversion. However, while the technology for these rebuilding efforts is innovative, it still leaves U.S. machinery manufacturing strengths primarily in the area of parts and servicing of existing machines—not a good prognosis for the future.

The U.S. textile machinery manufacturing industry is well aware of its declining markets in the area of new machine systems. In the introduction to a report from a cooperative grant between the American Textile Machinery Association (ATMA) and the U.S. Department of Commerce, ATMA acknowledges the problem:

... the U.S. textile and apparel machinery industries have not kept pace with the high-technology advances being developed and introduced by foreign competitors. The reasons for this lag include the industry's

inadequate attention to research and development, its failure to recognize the growing technological strength of foreign companies, and the lack of study and communication needed for the transfer of technology from one U.S. industry to another. Often, basic research conducted in the United States is being exploited by foreign competitors, instead of being adapted by U.S. industries. U.S. firms have not encouraged communication among themselves or with inventors; consequently, U.S. patent applications are now in the minority and continue to decrease.<sup>61</sup>

In order to correct for the above deficiencies, ATMA has recognized the need for machinery manufacturers to heighten their awareness of both machinery technology and the state of this technology within the textile industry. Along with the Department of Commerce, ATMA embarked in 1984 on a study to:

- identify needs for high-technology applications to textile and apparel machinery;
- identify potential resources of high-technology research and development, to be applied to textile and apparel machinery; and
- develop an organization to establish long-term approaches, including the development of a high-technology institute for the textile and apparel machinery industries, which would be aimed at the commercialization and the attainment of a greater share of the world market for U.S. manufacturers.<sup>62</sup>

Revitalization of textile machinery manufacturing is considered by most to be crucial to a strong domestic textile industry. Some believe, however, that machinery development in the future could better serve the industry if it were done by the textile manufacturers themselves, rather than by a separate machinery manufacturing sector. That more domestic R&D is needed is not debated; where and by whom, and with how much money and from whom, is very much in question.

<sup>60</sup>The previous two paragraphs are based largely on Ernst Nef, publisher, *International Textile Bulletin*, Zurich, Switzerland, personal letter, cited in "Technologies for the Textile and Apparel Manufacture in the U.S.," *op. cit.*, p. 341.

<sup>61</sup>American Textile Machinery Association, *Development of National Approaches to the Application of High Technology to the Textile and Apparel Machinery Industries*, for the U.S. Department of Commerce, Cooperative Grant No. 99-26-07170-10, October 1984, p. 1.

<sup>62</sup>*Ibid.*, p. 2.

**Chapter 4**  
**Areas for Decision:**  
**Trade, Technology,**  
**and Employment**



# Areas for Decision: Trade, Technology, and Employment

---

Having laid out each step of the fiber/fabric/end use production chain in chapter 3, this chapter will examine the role of textiles and apparel as a competitor in world markets and as a player in the U.S. economy. First, the chapter reviews global reactions to the increasingly international textile and apparel industry, outlines how the U.S. public and private sectors have responded to changing conditions at home and abroad, and addresses how the U.S. con-

sumer has been affected by these changes. Next, the chapter looks at recent developments in the research and development of new products and production techniques used by U.S. textile and apparel firms, and assesses the importance of capital investment to the future of the domestic industry. The chapter concludes with a discussion of the past, present, and potential future effects of trade and technology on those who work to produce textiles and apparel.

## DECLINING TRADE BALANCES SHAKE TEXTILE AND APPAREL MARKETS

Declining trade balances, perhaps more than any other single economic or technological issue, have been responsible for upheaval in the textile and apparel industry. The experience of this industry is part of an unfortunate recent trend in the trade performance of the U.S. economy. In 1986, the U.S. trade deficit was \$170 billion, and deficits were seen in virtually every manufacturing industry. The United States has become a debtor nation for the first time since World War I.

Textiles and apparel had a negative trade balance in 1986 of \$21.1 billion (see table 9). Approximately half of the value of apparel purchased in the United States is foreign-made, in contrast to two-fifths in 1984 and one-fifth in 1976.<sup>1</sup> In terms of volume, textile imports into the United States have grown by an average of nearly 15 percent per year since 1980, while the U.S. textile market has grown by only 1 percent per year. In addition, since 1985 imports have begun to penetrate new areas of the textile industry, including raw yarn and unfinished fabric, as well as household goods like draperies, sheets, and towels.<sup>2</sup>

<sup>1</sup>"America's Textile Industry: Holding Its Salvation in Its Own Hands," *The Economist*, Apr 5, 1986, p. 79

<sup>2</sup>W.E. Schmidt, "Textiles Defends Its Last Bastion," *The New York Times*, June 23, 1985, p. 4F

The origins of imports are diverse. The countries of the Far East—and increasingly China—have become major producers, and are penetrating the U.S. market. By 1985, import penetration in textiles had reached 33 percent, in apparel it had grown to 48 percent, and for industrial products and home furnishings it stood at 16 percent—increases of 100 to 500 percent over a decade earlier (see tables 10, 11, and 12).

The impact of current levels of import penetration on the economy in general, as well as on the textile industry in particular, is devastating. It is estimated that every billion yards of fabric and apparel imported represents 100,000 lost job opportunities to U.S. workers. Imports, therefore, may account for well over one million lost job opportunities, not to speak of the additional million lost through "ripple" effects.

The major trends affecting textile and apparel trade are:

- the emergence of a global marketplace for textiles and apparel,
- the growing protectionism of other nations,
- an "overly strong" dollar, and
- significantly lower wages and working conditions abroad.

**Table 9.—U.S. Textile and Apparel Trade**

	Textiles			Apparel			Textiles and apparel		
	Imports	Exports	Trade balance	Imports	Exports	Trade balance	Imports	Exports	Trade balance
	F.A.S. values <sup>a</sup>								
1970 .....	1,135	603	- 532	1,267	200	-1,067	2,402	803	-1,599
1971 .....	1,392	632	- 760	1,521	204	-1,317	2,913	836	-2,077
1972 .....	1,526	799	- 747	1,883	240	-1,643	3,409	1,019	-2,390
1973 .....	1,568	1,225	- 343	2,168	278	-1,890	3,736	1,503	-2,333
	C.I.F. values <sup>b</sup>								
1974 .....	1,752	1,795	+ 43	2,517	400	-2,117	4,269	2,195	-2,074
1975 .....	1,336	1,625	+ 289	2,826	403	-2,423	4,162	2,028	-2,134
1976 .....	1,791	1,970	+ 179	3,938	510	-3,428	5,729	2,480	-3,249
1977 .....	1,939	1,959	+ 20	4,493	608	-3,885	6,432	2,567	-3,865
1978 .....	2,400	2,225	- 175	6,108	677	-5,431	8,508	2,902	-5,606
1979 .....	2,399	3,189	+ 790	6,291	931	-5,360	8,690	4,120	-4,570
1980 .....	2,676	3,632	+ 956	6,849	1,202	-5,647	9,525	4,834	-4,691
1981 .....	3,250	3,619	+ 369	8,008	1,232	-6,776	11,258	4,851	-6,407
1982 .....	3,000	2,784	- 216	8,703	953	-7,750	11,703	3,737	-7,966
1983 .....	3,460	2,368	-1,092	10,292	818	-9,474	13,752	3,168	-10,585
1984 .....	4,874	2,382	-2,492	14,513	807	-13,706	19,387	3,189	-16,198
1985 .....	5,274	2,366	-2,908	16,056	755	-15,301	21,330	3,121	-18,209
1986 .....	6,151	2,570	-3,581	18,554	899	-17,655	24,705	3,469	-21,136

<sup>a</sup>F.A.S. Free Alongside<sup>b</sup>C.I.F.: Carriage Insurance Freight

SOURCE: U.S. Department of Commerce, FT-135, FT-140, SITC Classification 65 &amp; 84. Data are in millions of dollars

**Table 10.—The U.S. Textile Market**

	Imports <sup>a</sup>		U.S. fabrics	Import share of market %
	U.S. market (million SYE)	U.S. fabrics		
1973	29,613	5,124	24,489	17.3
1974	28,234	4,411	23,823	15.6
1975	27,036	3,829	23,207	14.2
1976	29,103	3,987	23,116	17.1
1977	30,364	3,976	24,374	16.4
1978	31,033	5,738	23,295	18.5
1979	30,431	4,639	25,792	15.2
1980	29,018	4,884	24,134	16.8
1981	28,866	5,776	23,090	20.0
1982	28,282	5,934	22,348	21.0
1983	30,537	7,706	22,831	25.2
1984	31,963	10,146	21,817	31.7
1985	32,652	10,831	21,821	33.2
1986		12,698		

<sup>a</sup>Imports include finished goods fabrics and yarn of cotton wool and manmade fibers only

SOURCE: American Textile Manufacturers Institute

**Table 11.—U.S. Apparel and Apparel Fabric Market**

	Imports <sup>a</sup>		U.S. fabrics	Import share of market %
	U.S. market (million SYE)	U.S. fabrics		
1973	15,557	4,313	11,244	27.7
1974	14,851	3,735	11,116	25.2
1975	14,363	3,351	11,012	23.3
1976	15,345	4,318	11,027	28.1
1977	16,044	4,270	11,774	26.6
1978	16,215	4,953	11,262	30.6
1979	15,627	3,988	11,639	25.5
1980	15,244	4,243	11,001	27.8
1981	15,405	4,976	10,429	32.3
1982	15,619	5,061	10,558	32.4
1983	16,341	6,139	10,148	37.9
1984	17,019	7,959	9,060	46.8
1985	17,334	8,322	9,012	48.0
1986		9,595		

<sup>a</sup>Imports include apparel and apparel fabrics and yarn of cotton wool and manmade fibers only

SOURCE: American Textile Manufacturers Institute

**Table 12.—U.S. Industrial and Homefurnishings Market**

	U.S. market	Imports <sup>a</sup> (million SYE)	U S fabrics	Import share of market %
1973	14,056	811	13,245	5.8
1974	13,383	676	12,707	5.1
1975	12,673	476	12,197	3.8
1976	13,758	699	13,089	4.9
1977	14,306	706	13,600	4.9
1978	14,818	785	14,033	5.3
1979	14,804	651	14,153	4.4
1980	13,774	642	13,132	4.7
1981	13,461	800	12,661	5.9
1982	12,663	874	11,789	6.9
1983	14,196	1,513	12,683	10.7
1984	14,944	2,186	12,758	14.6
1985	15,318	2,510	12,808	16.4
1986	—	3,103	—	—

<sup>a</sup>Imports include finished goods and nonapparel fabrics of cotton, wool, and manmade fibers only.

SOURCE: American Textile Manufacturers Institute.

### ***The Emergence of a Global Textile Industry***

The world population consumes more than 65 billion pounds of textile products per year, and consumption is currently growing annually by 1.7 billion pounds, or 750,000 metric tons.<sup>3</sup> Comparison of growth rates across regions of the world shows that textile growth within developing economies and planned economies has been faster in recent years than growth within older, more developed market economies. Virtually every nation in the world has at least a rudimentary textile industry—in order to serve its domestic market, provide jobs, and earn foreign exchange.<sup>4</sup>

The textile industry occupies a unique position in world trade and economic development. Because of the labor intensity of the industry and the low wage rates of developing nations, many countries view the industry as an initial rung on the ladder of industrialization. The industry is commonly viewed as one that, because of its labor intensity, can progressively displace the textile industries of more advanced nations. But as each developing country's own wage levels rise, developed industries will be displaced by producers in nations further "down the ladder"

<sup>3</sup>B. Toyne, et al., *The Global Textile Industry* (London: George Allen & Unwin, 1984), p. 68.

<sup>4</sup>Ibid., pp. 50, 70.

of industrializations. As a result, the governments of many developing nations promote the textile industry as part of an export strategy. In some cases, this has led to an overexpansion of capacity and a major export push in the 1980s, characterized by depressed prices and widespread use of import protection, export subsidies, dumping, and even quota fraud and smuggling.

In the past, the U.S. textile industry has been relatively insulated from the more dynamic international market. This situation is likely to change, because future growth in demand for apparel and other textile fabrics is expected to be largely outside the United States. United Nations projections are that the world population will grow by 850 million people between 1985 and 1995—when 75 percent will live in developing nations, 20 percent in those with centrally planned economies, and 5 percent in industrialized nations.

Textile industries throughout the world are highly competitive. There are few important economies of scale, only modest product differentiation, relatively small capital requirements compared to other manufacturing sectors, and no significant technological or resource-based barriers to entry. As a result, there is a minimum amount of seller market power. Coupled with the continued labor intensity of production, the more industrialized and high wage countries have great difficulties in gaining comparative advantage. These observations recently led scholars from several U. S., British, and Japanese universities to conclude:

Almost without exception, textile industries in OECD countries have negligible output growth, rising production costs, and declining employment. On the other hand, several developing countries with a relative abundance of labor have small but rapidly growing textile industries.<sup>6</sup>

The textile and apparel industry complex has plainly become a global enterprise. The industries in developed nations are disadvantaged by comparatively stagnant domestic markets, as well as high la-

<sup>5</sup>Thomas Howell, et al., "The Textile and Apparel Trade Crisis," study prepared for the Fiber, Fabric, and Apparel Coalition for Trade, August 1985, p. 1.

<sup>6</sup>Toyne, et al., op. cit., p. 110.

bor costs. Advanced equipment is available in international markets.<sup>7</sup>

The U.S. textile market is, by and large, mature and saturated. This is especially true for standardized, nonspecialty items. Most analysts agree that to have a strong future, the U.S. textile industry must focus on identifying competitive niches—especially for nonstandardized items—and aggressive marketing strategies at home and abroad. Many also argue that growing protectionism abroad must be matched by U.S. protection of its domestic industry.

The apparel trade deficit has reached a critical level; in 1986 it was nearly \$18 billion and growing (again see table 9). The real value of imports in the decade from 1975 to 1984 increased by over 240 percent, from \$5.5 billion to \$18.7 billion. At the same time, domestic production increased by less than 16 percent, meaning that an industry which had only 25 percent of its domestic consumption served by imports in 1975 had imports accounting for half of all consumption in 1984.<sup>8</sup> Nearly 30 percent of all cotton fiber poundage used by Americans for apparel and textiles is imported. For synthetic garments and fabrics the situation is less severe, with under 7 percent of all manmade fiber poundage consumed in the United States coming from imports. Domestic exports of apparel have expanded since the mid-1970s, but still vary greatly with respect to fashion trends and the value of the dollar.

Important in any analysis of apparel trade deficits is to distinguish between imports coming from actual foreign companies, products assembled abroad by U.S. firms, products manufactured by U.S. firms in joint venture with foreign firms, and products made by subcontractors catering to the orders of large U.S. retailers. The role of Item 807 products in increasing the apparel trade deficit also requires analysis.<sup>9</sup>

<sup>7</sup>Ibid.

<sup>8</sup>International Ladies' Garment Workers' Union Research Department, based on data from the U.S. Bureau of the Census, the U.S. Department of Agriculture, the U.S. Bureau of Labor Statistics, and the Textile Economic Bureau, 1986.

<sup>9</sup>Item 807 of the Tariff Schedules of the United States (TSUS) stipulates that if a product made of U.S. materials is manufactured abroad and then "reimported" into the United States, a tariff is to be paid on only the value added to that product during overseas production (see box B).

## The Export Market

**While** the key to domestic marketing is to recognize the growth areas within an overall static market, the key to international marketing is to increase export sophistication, recognize the areas in which U.S. technological comparative advantage exists, and adjust to the growing trade regulations that limit market entry. It is markets overseas that will experience the most future growth.

Even though growth is primarily in developing nations, the opportunities for expanded export marketing may exist primarily among other developed countries.<sup>10</sup> To meet this reality, it is argued that companies should seek out international multilingual marketeers to spearhead export drives. U.S. companies currently lack marketing staffs that are schooled in the trading knowledge and cultural affinity necessary to work effectively in a foreign environment of currency exchange and red tape.

Some see substantial opportunities, at least for some products, in the developing world as well. According to Du Pont Vice President David Barnes, for fibers and fiber products the export opportunities are broader than the already industrialized world:

The world market is three times the size of the present United States market and still growing . . .

Consumption of fiber products ranges around the world from about five pounds per person in the developing countries to more than a dozen times that in this country today. This not only suggests the breadth of growth opportunities but the diversity of markets we will have to serve if we want to be competitive on world levels.

American exports are competitive today because of the scale efficiency, higher capacity utilization, and higher productivity of American fiber and fabric producers as well as the downstream industries. These fundamental advantages will persist even when such temporary advantages as currency relationships and differing oil prices disappear or diminish over time.

Our industry is learning how to export to Europe the Far East and the developing countries. The U.S. has more than 20 percent of the world's textile capacity but has historically enjoyed only about 7 per-

<sup>10</sup>Jack C. Werner, "A Time to Lead: A Challenge and Opportunity for the U.S. Textile Industry," speech to annual meeting of the Board of Trustees of the Institute of Textile Technology, Charlottesville, VA, May 2, 1984, pp. 17-18.

cent of the export business. I believe we're going to move steadily towards a better balance.<sup>11</sup>

Barnes goes on to say that such progress in expanding exports is necessary to encourage higher levels of capital investment and to support the continuation of innovative research and development (R&D) activities needed to keep U.S. goods at the top of the competitive heap.<sup>12</sup>

The current U.S. export market for textiles and their end uses is quite small. Changes in worldwide trade barriers for textiles will be essential if markets are to open up for U.S. export. That event is the most critical. But technological and quality advantages, as well as substantially more aggressive overseas marketing—perhaps through overseas production facilities—are also necessary preconditions.

### Trade Regulations and Protectionism

**The Response of Developing Nations.—**Developing nations want the growing textile and apparel markets within their countries for themselves. A major response is to protect their own domestic markets with a variety of trade and marketing regulations. A 1984 survey of 21 major developing countries by the Secretariat of the General Agreement on Trade and Tariffs (GATT) found that average tariffs through the early 1980s ranged from 25 to 75 percent.<sup>13</sup>

In many individual instances, however, tariffs are much higher than these averages. In Brazil, for example, duties of up to 205 percent of c.i.f. value—"carriage insurance freight" value, which includes shipping and insurance costs—are imposed on imports of woven fabrics; on those of manmade fiber; woven apparel, and accessories; and on a number of other products. On top of this duty, Brazil places a variety of taxes and charges that further increase the cost to importers. The GATT Secretariat also reported that in addition to tariffs, the majority of these nations maintained quantitative restrictions on imports, ranging from quotas to outright import prohibitions.

<sup>11</sup>David Barnes, Vice President, Textile Fibers Department, E.I. du Pont de Nemours & Co., Inc. *Textile Industry Outlook*, Apr 25, 1980, p 6.

<sup>12</sup>*Ibid.*, p 7

<sup>13</sup>Howell, et al., *op cit.*, p 29

In general, restrictions are more stringent in downstream sectors of the industry, with apparel imports much more heavily protected by nontariff measures than textiles. The emphasis is on downstream sectors, since protection of the upstream and midstream sectors potentially creates competitive disadvantages for downstream apparel producers by raising the price of their inputs. Many developing nations have circumvented this problem by rebating duties paid on upstream imports used to produce export commodities, or by establishing "export process zones" in which fiber and fabric needed to produce export commodities are imported duty free.

A severe challenge faces U.S. producers of textile products as they search for niches in the global textile market, because import restrictions have proliferated so extensively in recent years. Besides tariffs, restrictive activities include embargoes, quotas, licensing requirements, prior authorization rules, and border taxes.

**Self-Imposed Barriers.**—Many countries ban textile imports altogether. Bolivia prohibits the importation of 19 categories of textile products, among which are carpets and blankets; cotton outerwear for men and boys; cotton outerwear for women, girls, and infants; men's and boys' underwear; underwear for women, girls, and infants; and continuous acrylic fiber yarns.<sup>14</sup> Egypt bans the importation of woven fabrics of eight categories of textile products, among which are carded or combed cotton; bed, table, and kitchen linens; and raw flax.<sup>15</sup> Afghanistan bans the importation of handbags, cotton yarn, rugs of artificial fibers and wool, turban cloth of silk, and traveling blankets and rugs.<sup>16</sup>

The Korean Federation of Textile Industry stated in 1981 that many developing countries "are gradually eliminating themselves as textile markets."<sup>17</sup> In 1983, the Textile Minister of Sri Lanka announced a total ban on textile imports, stating: "Now we do not need foreign competition any more."<sup>18</sup>

<sup>14</sup>U.S. Department of Commerce, International Trade Administration, Office of Textiles and Apparel, "Foreign Regulations Affecting U.S. Textile/Apparel Exports," April 1986, p 20

<sup>15</sup>*Ibid.*, p 78

<sup>16</sup>*Ibid.*, p 1

<sup>17</sup>Korean Federation of Textile Industry, *Textile Industry in Korea* 1981/81, p 18.

<sup>18</sup>Howell, et al., *op cit.*, p 30

In other nations, textiles are taxed at prohibitive rates. In Burma, for example, items such as ready-made wool clothes, silk cloth, and artificial silk are taxable at 60 percent; jute carpet is taxable at 50 percent; and lace synthetic textiles, textiles made of combed cotton, imitation leather, and noncotton blankets are all taxable at 40 percent.<sup>19</sup>

South Korea maintains a strict system of import controls with a "Negative List." Imports, which must receive prior approval of an appropriate ministry, are allowed on a controlled basis, and only if they are for prompt use to manufacture goods that will be sold in the export market.

Taiwan virtually bans apparel imports, and strictly limits imports of textile fiber. But it does allow imports of textiles if they are for prompt use in the manufacturing of goods sold in the export market.

Colombia maintains restrictions amounting to a de facto ban on most textile and apparel imports. The government requires the granting of import licenses for about 65 percent of its textile and apparel tariff categories. As of early 1985, no licenses were being granted. Surcharges are imposed on those products whose importation is allowed in order to finance a 6.5 percent textile export incentive for Colombian products.

**Government Subsidies.**—Beyond import restrictions, foreign trade is also influenced by the substantial government subsidies that many nations provide their textile industries. A principal source of capital for the South Korean textile industry during its years of rapid growth, for example, was the preferential allocation of credit by government-dominated banks at below-market interest rates. The wide range of export subsidies and incentives given by the Korean government to its textile exporters was estimated by the World Bank to have a subsidy value of 27 percent in 1972.<sup>20</sup> In addition, Korea has frequently been charged by other countries with dumping their textile products<sup>21</sup>—a charge which the Koreans have even occasionally acknowledged themselves. Dumping, however, is by no means unique to South Korea.

Taiwan offers its textile exporters financial benefits, including tax breaks. Between 1974 and 1979 alone, the Taiwanese Government provided \$300 million in loans to textile producers, enabling them to "modernize their equipment and improve product quality."<sup>22</sup> Most of Taiwan's textile and apparel mills have been located in three special export processing zones, where manufacturers can import duty-free production equipment as well as intermediate goods and raw materials used for production of exports—a system that enables the nation to protect its upstream and midstream home industries without jeopardizing its downstream manufactured goods.

Hong Kong also utilizes a customs free zone, and thus takes advantage of the large stocks of upstream and midstream textile products available on the international market. Its strategy is to concentrate production on the downstream apparel end of the industry.

In 1979, China decided to promote textiles as a leading economic priority.<sup>23</sup> As a result of this decision, the Chinese textile industry received special loans from the central government; greater allocations of resources from the provinces, municipalities, and autonomous regions; and was given priority with respect to raw materials, transport, and electric power. New textile facilities are concentrated in special economic zones and receive special tax and regulatory treatment, designed to encourage foreign investment and the manufacture of exports.<sup>24</sup>

Also significant in China is a government export-stimulus program designed to manipulate the exchange rate, and an allocation of foreign exchange earnings to enterprises engaged in exports. This involved the implementation of a dual exchange rate system, designed to discourage imports and stimulate exports between 1981 and the beginning of 1985. While the official exchange rate was 2.0 renminbi (RMB) to the dollar, enterprises remitting dollars earned in foreign trade to the Bank received 2.8 RMB per dollar, and were required to pay 2.8 RMB for dollars used in purchasing imports.<sup>25</sup> The policy

<sup>19</sup>Ibid.

<sup>20</sup>World Bank, *Industrial Policy and Development in Korea*, Staff paper No. 236, 1975, cited in Howell, et al., op. cit., p. 50.

<sup>21</sup>*Japan Economic Journal*, Apr. 26, 1983, and *JTN*, November 1984, cited in Howell, et al., op. cit., p. 53.

<sup>22</sup>*Free China Weekly*, Oct. 7, 1979, cited in Howell, et al., op. cit., p. 55.

<sup>23</sup>Ibid., p. 64.

<sup>24</sup>Ibid., p. 69.

<sup>25</sup>Ibid., pp. 75-77.

has been described officially by the Chinese in the following ways:

The internal settlement rate is used only to subsidize exports and it cannot be called an exchange rate. It is a means of subsidizing our export industry ... 26

China intends to use the profits it makes on imports to subsidize exporting enterprises mak[ing] a loss.<sup>27</sup>

Other nations with emerging export markets in textiles are also using import restrictions and export subsidies to promote their textile industries. Among them is Thailand, which combines stringent import protection with liberal grants of export subsidies.

The Indonesian Government utilizes an export incentive system to pay compensatory money to exporters. Imports of cloth with batik motifs, sarongs, and cambric made with cotton yarn are banned altogether; imports of cotton weaving yarn are restricted to specified approved importers or government agencies; and all imports are subject to surcharges ranging as high as 200 percent.<sup>28</sup> The value of the Indonesian export subsidy on textiles was between 16 and 43 percent as of 1978.<sup>29</sup> In addition, a 1978 devaluation of the national currency had a dramatically positive impact on Indonesian textile trade.

In Pakistan, where more than half of the country's total industrial employment is engaged in textiles and apparel, the government made its foreign exchange reserves available to finance acquisition of foreign production equipment; these imports were exempt from customs duty. In addition, the government encouraged domestic banks to provide loans to producers, which could finance the acquisition of domestically made textile machinery. Tax incentives were provided for the installation of modern production equipment.<sup>30</sup>

In the Philippines, government import protection involves quantitative restrictions and a high nominal tariff level—a 100 percent tariff on garment im-

ports. At the same time, it permits duty-free import of textiles used to produce clothing for export. Garment producers are eligible for investment incentives. With the help of the World Bank, the government in 1979 launched a major program to expand and modernize textile production. The Central Bank of the Philippines provided credit at below-market interest rates to finance the production of textile goods for export.<sup>31</sup> Of eight sample textile firms, the value of investment incentives to textile producers was between 2.9 and 10.6 percent of total sales.

Although allowing their textile industries to escape from the economic realities of competition has increased the foreign exchange standing of some developing countries, clearly improving prospects for industrial employment at home, the effects of such restrictions and subsidies have not been completely positive. Industries being created and expanding under heavy government protection have in many countries grown beyond their capacity to sell their products. Nations have incurred substantial foreign exchange debts to pay for modernized plant and equipment. And some have argued that high levels of protection have been responsible for a de-emphasis on efforts to improve efficiency and productivity.

**Response of Japan and the European Economic Community.**—Another part of the explanation for the unprecedented penetration of textile imports into the United States has to do with the response of the European Economic Community (EEC) and Japan to the emergence of a global textile market and increased competition, especially from developing nations. The EEC restricts imports pursuant to bilateral agreements negotiated under the Multi-Fiber Agreement (MFA) (see box A). Since 1983, restrictions by the EEC have become significantly stronger. Japan restricts imports more informally—by placing pressure on the distribution network, and by concluding a variety of non-MFA bilateral restraint agreements. Internally, Japan has implemented significant restraints on competition in order to prevent a “shakeout” of producing firms, as has the EEC with synthetic fiber production. In addition, EEC governments have provided significant amounts of financial aid to their textile and apparel producers.

In the United States, import restrictions pursuant to MFA have been used, but the system is viewed

<sup>26</sup>Weij Yunming in *Far Eastern Economic Review*, Dec. 25, 1981, cited in Howell, et al., op. cit., p. 77.

<sup>27</sup>Xinhua, reported on Dec. 16, 1980, Item No. 121518, cited in Howell, et al., op. cit., p. 77.

<sup>28</sup>*Ibid.*, p. 91.

<sup>29</sup>Ajia Keizai Kenkyujo, *Hatsuten-tojo-Koku no Seni Sangyo*, 1980, cited in Howell, et al., op. cit., p. 89.

<sup>30</sup>*Ibid.*, pp. 94-96.

<sup>31</sup>*Ibid.*, pp. 101-1 OS

### Box A.—The Evolution of the Multi-Fiber Arrangement\*

In 1974, the Multi-Fiber Arrangement (MFA) was adopted to provide guidelines for the regulation of textile and apparel quotas; MFA's provisions have since been revised three times. MFA replaced several earlier programs designed to limit U.S. textile imports, which are described below.

The United States placed limited quotas on Japanese cotton textiles in 1956. However, other nations in the Pacific Rim soon entered the U.S. market, prompting a U.S. effort at multilateral action: the Short-Term Agreement Regarding International Trade in Cotton Textiles, established in 1961. This agreement allowed for the limitation of specific import categories, in order to protect domestic industries against undue disruption.

The following year saw the implementation of the Long-Term Agreement (LTA), which replaced the 1961 effort. LTA allowed for the negotiation of temporary bilateral agreements if U.S. markets were disrupted significantly, through a rapid increase in imports of a specific product, prices that were well below those for similar domestic goods, or potential or actual damage to U.S. manufacturers.

Under LTA's purview, the United States negotiated 30 bilateral agreements between 1961 and 1972. However, LTA did not cover imports of synthetic materials, which grew tenfold during the 1960s. A more comprehensive agreement was needed to regulate this burgeoning sector of textile and apparel production.

That agreement would come in 1974, with the introduction of MFA.\*\* The United States had already negotiated several bilateral agreements with Pacific Rim nations concerning synthetic fibers. MFA, officially known as the Arrangement Regarding International Trade in Textiles, established guidelines by which developed countries could control imports of textiles and apparel made of wool, cotton, or synthetic fiber; subsequent revisions—the last was in 1986—have added silk, linen, and ramie to the list. All told, 35 bilateral agreements have been made by the United States in accord with MFA's provisions.

The Multi-Fiber Arrangement is designed to provide U.S. firms with the time to adapt to changing economic conditions (brought about by the growth of imports); its language does not indicate that it should be used as a tool for industrial revitalization. MFA calls for trade agreements that are designed to be temporary, focusing on a specific product from an individual country that has caused or threatened disruption of the U.S. market. MFA also allows for flexible quotas; for example, exporting nations can rearrange quota levels from different years or product categories. However, the three revisions of MFA have given more power to the importing nation in setting rigid quotas.

\*This information is drawn from U.S. Congress, Congressional Budget Office, *Has Trade Protection Revitalized Domestic Industries?* (Washington, DC, November 1986), pp. 21-23.

\*\*For the text of MFA, see International Trade Commission, *The Multifiber Arrangement, 1980-1984*, app. A.

as quite lax (see discussion below). Available evidence suggests that the EEC's adoption of a more restrictive regime under the MFA as of 1983, coupled with Japan's continuing restrictions, has had the effect of channeling developing nation textile exports into the U.S. market.

Since the implementation of new EEC restrictions in 1983, for example, many of the major suppliers, such as Taiwan, Korea, and Indonesia, have experienced a significant drop in export volume to the EEC, and a dramatic rise in the volume shipped to the United States. Whereas U.S. imports per capita for the textile sector from developing nations between 1980 and 1984 rose from \$5.09 to \$10.11, EEC im-

ports declined from \$11.82 to \$8.30. The apparel sector changes were even more dramatic. In the United States, the per-capita value of imports from developing nations more than doubled, from \$25.56 to \$56.63; in the EEC, it declined from \$22.38 to \$18.47 (see table 13).

While Japan and the EEC had a positive net trade balance between 1980 and 1984 in the textile sector, the United States—which began positively in 1980—developed a sharply negative net balance. In the apparel sector, while all three experienced a negative net trade balance, only the U.S. experienced a sharp deterioration in its balance. Japan maintained roughly the same percentage of overall im-



**Table 13.—U.S. and EEC Imports From Developing Countries Dollars Per Capita, 1980-84**

	Textiles		Clothing	
	EEC	U.S.	EEC	U.S.
1980 .....	\$11.82	\$5.09	\$22.38	\$25.56
1981 .....	8.55	5.83	20.98	29.19
1982 .....	7.95	4.99	19.25	30.73
1983 .....	7.86	5.97	17.55	35.61
1984 .....	8.30	10.11	18.47	56.63

SOURCE *The Textile and Apparel Trade Crisis*, based on international Monetary Fund data

ports from developing nations between 1980 and 1984. During the same period, however the EEC countries imported a lower percentage of textiles and apparel from the developing world, while the United States imported a sharply higher percentage (see table 14)

### **U.S. Response**

The impact of significant import protection and export subsidies on the textile industries of developing countries has been severe. Domestic production has been threatened through increased competition within home markets, and increased restrictions and competition in international markets. Not surprisingly, textile companies in industrialized nations, as well as the governments of those nations, have responded to the threats that they face from noneconomic competition in textile trade.

### **Factors Behind Varying Costs**

**Differences in Wages.**—**Employees** of U.S. textile and apparel firms pay substantially higher wages than firms in Asia and Latin America, although industry wages are among the lowest in U.S. manufacturing. At \$6.71 per hour in 1985, a full-time U.S. textile mill products worker earned just under \$14,000 per year; in contrast, his/her average hourly earn-

ings were more than 33 times higher than a comparable Chinese worker earning 20 cents per hour. At \$5.73 per hour in 1985, a full-time U.S. apparel worker earned just under \$12,000 per year, but that was approximately 28 times more than the comparable Chinese worker earning 20 cents per hour.

Although direct wage comparisons between a centrally planned economy and the U.S. economy are clearly inexact, the fact remains that labor costs for U.S. textile and apparel enterprises—indeed, for enterprises from the entire developed world—are higher than those for firms operating in developing countries. This is accentuated by differences in benefits and working conditions, largely a function of the fact that many developing nations lack standards that protect against long hours, long weeks, safety, and health hazards. Some even use child labor. According to the International Ladies' Garment Workers' Union (ILGWU), in 1984, "labor compensation in the developing and newly industrialized countries ranged from 2 to 25 percent of the U.S."<sup>32</sup>

Some U.S. companies attempt to lower their labor input costs by establishing production facilities overseas. Especially in the apparel industry, where labor intensity continues to be very high, production and/or assembly overseas may provide some economic advantages for individual companies. In fact, such a strategy is encouraged through U.S. public policy by the "807" rule, which places a tariff not on all textile and apparel imports, but only on the value added by specific operations performed outside the United States—in other words, a U.S. firm can send fabric to a low cost production facility overseas, substantially reducing input costs. However, there are risks associated with such movement. Po-

<sup>32</sup>Letter from Dr. James Parrott, Assistant to General Secretary-Treasurer Jay Mazur, International Ladies' Garment Workers' Union, to OTA, Mar. 31, 1986, p. 4.

**Table 14.—Percent Share of Exports of Textiles and Clothing From Developing Countries by Major Developed Country Markets, 1980-84**

	EEC			U.S.			Japan		
	EEC	U.S.	Japan	EEC	U.S.	Japan	EEC	U.S.	Japan
1980 .....	26.80/o	9.90/0	6.4°/0	40.1%	40.0%	5.8%	34.1%	26.7%	6.4%
1981 .....	18.2	10.5	5.9	33.9	39.9	6.7	27.1	27.2	6.4
1982 .....	18.4	9.9	32.2	43.9	7.0	26.4	29.6	6.7	
1983 .....	16.8	11.0	4.9	27.8	48.5	5.1	23.1	32.5	5.0
1984 .....	14.8	15.5	5.6	23.4	61.8	5.8	19.8	42.5	5.7

SOURCE *The Textile and Apparel Trade Crisis*, based on data from GATT

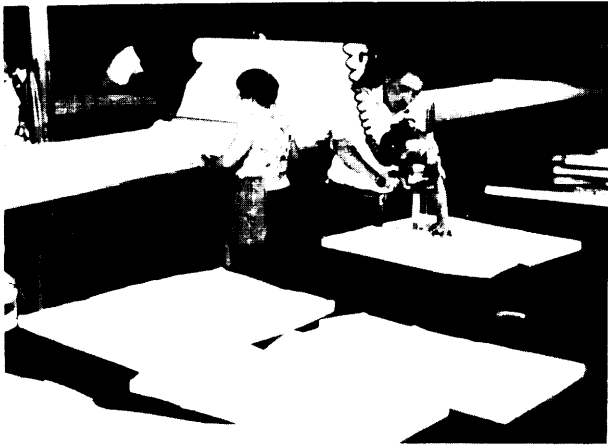

Photo credit: Copyright (©) 1986, 1987 by Bobbin International, Inc.  
All rights reserved

This cutting and shipping facility is located in Hiialeah, FL. Cut goods are delivered to two plants in Costa Rica for sewing, and then reimported to the United States.

litical instability in many low wage countries can make production unreliable.

**Exchange Rate Fluctuations.** -During 1983 and 1984, the dollar rose in value more than 30 percent against the currencies of other industrial countries. This appreciation, according to many analysts, was no different than a 30 percent tax on exports and a resulting 30 percent cost advantage for imports.<sup>33</sup> The 1983-84 appreciation came on top of an appreciation of equal magnitude in the previous 3-year period. Weighing the currency average of the 20 nations with whom we most heavily trade in textiles suggests that the value of the textile dollar in the second quarter of 1986 was almost another 30 percent above 1984; of course, the recent decline in the dollar's value against other currencies has since helped to reconcile this difference.

However, while the appreciation of the dollar clearly exacerbated the textile trade problems of the early and mid-1980s, many experts are quick to emphasize that massive shifts in worldwide textile trade patterns are the result of other factors as well. For example, whereas imports from the Dominican Republic and Haiti increased by 40 and 28 percent, respectively, between 1981 and 1984, the exchange rate did not change at all. Large increases in import

penetration by other major textile supplying countries are also recorded, despite far less substantial changes in bilateral exchange rates. According to an analyst at ILGWU, the dollar's rise did contribute to sizable percentage import increases from a number of nations in the EEC, but EEC countries accounted for only 2.2 percent of all apparel imports in 1984.<sup>34</sup>

### Policy Reactions

At the government level, the United States, the EEC, and Japan have all acted to limit the growth of imports from developing nations. But while the United States has taken a number of steps to protect its domestic enterprises, U.S. markets are much more open than those in Europe and Japan. A study by European economists concluded that:

While all governments adopted protectionistic policies for their textile mill products industries during the 1960s and 1970s, the United States government seemed to be the only one that did not couple this policy with one of the other policy types. Instead, it preferred to let internal, partially protected market forces bring about adjustment. It persistently opposed the concept of direct government intervention of the types undertaken by its counterparts in Europe and in the Asia Pacific Region.<sup>35</sup>

As a result, the United States is absorbing a large share of the world's textile and apparel exports, at the expense of its domestic industry. Moreover, a trade imbalance has resulted from the fact that U.S. exports of textile and apparel are not significant. At the peak of apparel exports in 1980, for example, they did not amount to more than 3 percent of domestic apparel production.

**U.S. Enforcement of Existing Trade Laws.— Ineffective administration of the Multi-Fiber Arrangement (MFA) is one reason given for the unprecedented surges in imports and harm to the domestic textile and apparel industry. Despite the existence of the MFA, which contemplated a 6 percent annual growth rate for imports, imports (in terms of square yard equivalents) grew 30 percent in 1983 and 32 percent in 1984, before falling to 7 percent in 1985; 1986 growth rose again, however, to over 17 percent. Legislation before Congress to require more**

<sup>33</sup>AFL-CIO, "30th Anniversary Report of the AFL-CIO Executive Council, 16th Convention," Oct. 28, 1985, p. 156.

<sup>34</sup>Letter from Dr. James Parrott, Op. cit, P. 3.

<sup>35</sup>Toyne, et al., pp. 178-179

## Box B.-Trade Regulations That Affect Textiles **and** Apparel

Currently, the United States can call upon one of several trade policy tools that help U.S. industries compete in world markets, in the United States, and against the unfair trade practices of other countries. In addition to multilateral negotiations through the Guaranteed Agreement on Trade and Tariffs (**GATT**) and bilateral action through the Multi-Fiber Arrangement (see box A), two sections of the Trade Act of 1974 and one classification item from the Tariff Schedules of the United States (TSUS), have been applied to trade of textiles and apparel:

### *Section 201 of the Trade Act of 1974*

This section, commonly referred to as the “Escape Clause,” is invoked when a U.S. industry has been or feels threatened by competition from imports of a particular product into the United States. An investigative board of the International Trade Commission is established to verify the industry’s claim. Unless the commission finds the industry’s claim to be unsubstantiated, the President then has the option to implement import relief measures in a nondiscriminatory manner—in other words, the President cannot single out specific countries against which to take action. He may only take action against all imports of a product, since Section 201 is designed to help U.S. industries against all other competitors in a given product field. If the President does not act on the domestic industry’s behalf, Congress may do so through a joint resolution enacted within 90 days of the President’s decision.

### *Section 301 of the Trade Act of 1974*

This section deals with the unfair trade practices of other countries that affect U.S. industries. Since other U.S. regulations have been created to address the problem of illegal “dumping” of exports into the U.S. market, and to respond to excessive subsidies of exports to the United States by foreign governments, most petitions now filed under Section 301 relate to an alleged unfair practice in a third-country market. If U.S. apparel exports to the EEC, for example, are restricted by a competitor country’s apparel exports that have been subsidized by the competitor’s government, then the apparel industry can petition the U.S. Special Trade Representative to recommend that action be taken against the competitor. The President may attempt to negotiate the elimination of the unfair practice; should this fail, he may then impose retaliatory measures against the competitor. In contrast to Section 201, which is **product-specific**, **Section 301** is country-specific. However, it is important to note that Section 301 is designed to eliminate an unfair practice, not to begin a trade war.

### *Classification Item 807 of the Tariff Schedules of the United States (TSUS)*

Item 807 mandates that a tariff be placed on a product that is manufactured overseas with U.S.-made material. The tariff applies only to that part of a product’s value that is added outside the United States, and the rate to be paid accords with whatever rate is normally paid upon importation of the product. A U.S. company, for example, may elect to take advantage of low-cost foreign labor costs and send U.S.-produced fiber to another country for manufacture, only to reimport the fiber in the form of a finished shirt. Countering the cost advantage, however, is the fact that political instability in low wage nations can place a great deal of risk on a decision to manufacture products abroad.

vigorous enforcement of the MFA was opposed by the Reagan Administration.<sup>36</sup> In the MFA protocol signed in Geneva on July 31, 1986, “none of the improvements sought by the industry are in the new agreement except for coverage of additional fibers.”<sup>37</sup>

Senator John Danforth (R, MO) blames many problems on the Administration “refusing to enforce laws already on the books”<sup>38</sup> (see box B). One example

of the lack of enforcement was cited by Senator Ernest Hollings (D,SC):

We have a bilateral agreement with Thailand. In 1984 and 1985 Thailand overshipped apparel to the tune of almost 30 million square yard equivalents. This overshipment was not discovered by the Department of Commerce until August of 1985, at which time, Thailand had shipped in [to the United States] apparel for 1985 already filling 82 percent of their 1985 *quota*. According to the office of our chief tex-

<sup>36</sup>AFL-CIO, “The National Economy and Trade. AFL-CIO Policy Recommendations for 1986,” October 1985, pp 26-27.

<sup>37</sup>American Textile Manufacturers Institute, *Textile Highlights*, September 1986, p. iv

<sup>38</sup>Clyde Farnsworth, “Watchdog of U.S. Trade,” *New York Times Magazine*, Sept. 14, 1986, p. 88

tile negotiator, Ambassador Carlisle, "Frankly, the system did not work . . . It was inadequate." That is an understatement. After discovering illegal massive shipments in mid-August, apparel shipments from Thailand were finally embargoed on October 8th. Negotiations with the Thais were begun. These negotiations are now completed and I understand from Ambassador Carlisle's office that the embargo will be lifted one month prematurely on December 1st. This will enable the U.S. importers to get their goods out of embargo in time for the Christmas season. The embargo will be lifted even though the Thais over-shipped in 1984 and are probably going to be over their quota in 1985.

Further, the overshipments for 1984 and 1985 will not be charged against Thailand's 1986 quota.<sup>39</sup>

President Reagan made the following two pledges to the textile community as he vetoed HR-1562, the congressional effort to protect the apparel, textile, copper, and shoe industries:

I am directing Secretary of the Treasury Baker, as Chairman Pro Tempore of the Economic Policy Council, to investigate the import levels of textiles and apparel to determine if these imports have exceeded those limits agreed upon in international negotiations. I have directed that he report back to me within 60 days and recommend changes in existing administrative and enforcement procedures, if necessary . . .

Also, I am directing the Office of the United States Trade Representative to most aggressively renegotiate the Multi-Fiber Arrangement (MFA) on terms no less favorable than present. Our trading partners must be put on notice that we will not allow unfair trading practices to continue.<sup>40</sup>

Nonetheless, many examples of poor enforcement have been cited by critics of existing procedures:

- Even though the Treasury Department had requested additional customs personnel to be posted abroad to stop textile fraud, the State Department refused to authorize the additional agents. Currently, only about 2 percent of what comes into the United States is actually inspected by customs officials. This is despite the fact that customs agents usually earn two to three times their salary in tariffs collected.<sup>41</sup>

- Even though the textile industry has filed a series of countervailing duty cases against several countries, the Administration negotiated agreements to suspend most of those duties,
- There have been many charges of dumping of textiles against foreign nations. The producers of nylon impression fabric, for example, have long been concerned that imported impression fabric from Japan has been and is being dumped in the United States.<sup>42</sup>
- Transshipments to evade quotas abound. According to testimony received by the House Government Operations Committee, garments that come into the United States under the 807 agreement often involve fraudulent transshipments. In review of U.S.-Canada free trade negotiations, the House Committee on Ways and Means in 1986 invited written comments, Many of these comments expressed fear of Canada becoming a "pass through" point for the Far East if a free-trade arrangement were negotiated.<sup>43</sup>

There has been some experience in the past with Canada being a transshipment point for textile products from the developing world. After the 1978 antidumping duty order, Nissei Sangyo of Japan apparently began transshipping broad woven nylon impression fabric through Canada.<sup>44</sup> The executive director of the Neckwear Association of America expressed his industry's concern with a free-trade agreement:

. . . our industry is very concerned about the potential of transshipments through Canada. Because of the low unit value of neckwear, especially from the Far East, the elimination of duties will make transshipment through Canada particularly attractive. We are not sanguine about enforcement as Customs is not able to cope with its present responsibilities.<sup>45</sup>

The executive director of the Work Glove Manufacturers Association also argued against a free-trade agreement, saying that:

<sup>42</sup>Statement of Bomont Industries, Inc., cited in "Written Comments on Proposed U.S.-Canada Free Trade Agreement," Subcommittee on Trade, Committee on Ways and Means, U.S. House of Representatives, April 1986.

<sup>43</sup>Written Comments on United States-Canada Free Trade Negotiations," op. cit., p. 346.

<sup>44</sup>Statement of Bomont Industries, Inc., op. cit., p. 69.

<sup>45</sup>"In Opposition to Proposed U.S.-Canada Free Trade Agreement," Statement of Gerald Andersen, Executive Director, Neckwear Association of America, cited in "Written Comments on United States-Canada Free Trade Negotiations," op. cit., p. 215.

<sup>39</sup>Statement of Senator Ernest Hollings on Thailand, Nov. 13, 1985.

<sup>40</sup>Veto message of President Ronald Reagan, HR-1562, Dec. 17, 1986.

<sup>41</sup>George Wino, Chief Economist, American Textile Manufacturers Institute, interview of Nov. 18, 1986.

Such an arrangement could not only take advantage of duty-free access to the U.S. market, but permit the circumvention of quota arrangements as well. The U.S. Customs Service already has its hands full with its regular import monitoring programs. Recent personnel cutbacks will make it impossible for Customs to guard effectively against transshipments.<sup>46</sup>

- The House Commerce Committee published an investigative report on textile fraud in April of 1985, and found widespread quota violation and evasion. Examples included shipments of young men's sportswear from Hong Kong, China, and the Philippines for nearly 5 years by means of false documents; 1,700 dozen pairs of Taiwanese jeans falsely claimed as having been manufactured in South Africa; a Taiwanese importer sewing shirts and skirts together and entering almost 10,000 dozen of them as dresses, which had a lower duty rate and a larger quota. The importer admitted the items were separated after entry and sold as shirts and skirts.

**Recent Legislative Proposals.-The relative "openness"** of U.S. markets has become a point of extensive controversy. In 1986, Congress passed legislation designed to shield the industry from imports, but the Reagan Administration vetoed this bill (HR-1562). The administration argued the economic advantages of market equilibration and the consumer advantages of lower cost textiles and apparel. Senator Danforth, former chairman of the Senate Finance Committee's trade subcommittee, argued that other countries should either reduce their barriers to trade or face equivalent restrictions. He would use the \$360 billion annual American market for both a carrot and a stick.<sup>47</sup>

The 100th Congress is likely to vote on another textile import bill, which has been introduced by Senators Hollings and Strom Thurmond (R, SC); Representative Butler Derrick (D, SC) has introduced the same bill in the house. This legislation (S-549 and HR-1154) calls for a general import ceiling, which is designed to limit import growth to the growth of the U.S. domestic market. The bill's sponsors con-

tend that they have addressed several of the problems cited by opponents of the bill vetoed by the President:

- quotas would be set against imports from all countries, rather than against those from the developing world only;
- upper limits against specific countries would not be mandatory, but the President would have the authority to set individual quotas within the overall amount;
- quotas would not require rollbacks of foreign shipments; and
- foreign suppliers would be compensated for lost sales.<sup>48</sup>

### Private Sector Reactions

**An Increase in Capital Investment. -Chapter 3 indicated that** U.S. producers have invested heavily in more advanced production equipment, enabling them to offset the lower wage levels of developing nations.<sup>49</sup> Some of the more labor-intensive aspects of apparel production have been moved offshore. Similar developments are occurring in the EEC and Japan. In all three geographic markets, fiber and fabric producers are establishing vertical links with downstream apparel producers. In the United States, textile mill product manufacturers reinvested between 80 and 85 percent of their retained cash flow between 1975 and 1985, spending an average of \$1.4 billion per year on new plant and equipment. This average rose to \$1.8 billion between 1984 and 1986.<sup>50</sup>

U.S. firms have invested in such innovations as robotics, computer control systems, and shuttleless looms in order to improve productivity. Reflecting these investments, U.S. textile mill producers' productivity levels increased at more than twice the level of all U.S. manufacturing industries in the decade from 1975 to 1985—5.6 percent v. 2.4 percent per year. Productivity levels in the United States were also substantially higher than in nations overseas in 1981. Increased productivity, however, has been accompanied by decreased profitability; as a result,

<sup>46</sup>In Opposition to the Proposed U, S.-Canada Free Trade Agreement, "Statement of Craig Schulz, Executive Director, Work Glove Manufacturers Association, Chicago, cited in "Written Comments on United States-Canada Free Trade Negotiations," op. cit., p 344.

<sup>47</sup>Clyde Farnsworth, op.cit.

<sup>48</sup>"Compromise Textile Bill Being Readied," *The Washington Post*, Feb. 13, 1987, p. F1

<sup>49</sup>This paragraph is based largely on Howell, et al., op. cit., pp. 117-110 and 172-173.

<sup>50</sup>*Textile Highlights*, op. cit., p. 21.

marketing strategy in this area becomes fused with technological development and capital investment.

**The “Buy American” Program.-The industry has worked actively to make U.S. consumers more aware of U.S.-made goods. This is largely being done through** the “Crafted With Pride in U. S. A.” campaign. Labels and tickets are displayed prominently on U. S.-made apparel, and there is an extensive advertising campaign. Such major retailers as Wal-Mart and J.C. Penney are featuring U.S. products.<sup>51</sup>

The Crafted With Pride in U.S.A. Council has nearly 400 members, Their statement of purpose is simple and direct:

The Crafted With Pride in U.S.A. Council is a committed force of United States cotton growers, labor organizations, fabric distributors, and manufacturers of manmade fibers, fabric, apparel, and home fashions, whose mission is to convince consumers, retailers, and apparel manufacturers of the value of purchasing and promoting U.S.-made products.<sup>52</sup>

Surveys by Roper Reports have consistently found a “Made in the U. S. A.” label to be regarded as “superior or fairly good” by 93 to 95 percent of those queried. Gallup polls show that Americans regard U.S.-made clothing to be “as good or better than overseas” by 75 percent of Americans.<sup>53</sup>

Since 1984, manufacturers have been required by law to label domestically-made products with the words “Made in the U. S. A.” To persuade consumers to look for those labels before making a purchase, Council members pledged \$40 million in advertising over a 3-year period, They engaged such stars as Bob Hope, Diahann Carroll, Sally Struthers, O.J. Simpson, Lynda Carter, and Sammy Davis, Jr., to appear on television commercials on their behalf.

Encouraging news about the Crafted With Pride program came from a spring 1986 experiment by Hanover House Industries, a national catalog house. Two versions of a catalog were mailed to consumers. Four million catalogs were sent in all, In one version, 56 specific items carried a special “Made in the U. S. A.” logo. Sales returns from consumers receiving this catalog were 10 percent greater than the

<sup>51</sup>Bruce Stokes, “Getting Competitive,” *National Journal*, June 7, 1986, p. 1365,

<sup>52</sup>American Textile Manufacturers Institute, advertisement in *Time* Magazine, September 1986.

<sup>53</sup>1 bid

identical catalog without the “Made in the U. S. A.” logo.<sup>54</sup>

The Auburn University Apparel Sourcing Fair of February 1986 is just one example of efforts underway to promote domestic apparel products. This, the Nation’s first sourcing fair, brought State manufacturers and retailers together from Alabama and surrounding States. Participating retailers repeatedly stated that they were looking for partners, in the form of manufacturers who could fit their products within the structure of retail lines, and of contractors who could take on more of the burden of production by supplying the complete package.<sup>55</sup>

### **Trade and the U.S. Consumer**

Competitive advantage of textile and apparel exports stems primarily from lower wages in exporting nations, which reduce production costs in both material manufacture and assembly. But even though it may cost producers only one-fifth as much to make their goods abroad, the U.S. consumer may not necessarily enjoy a similar reduction in price. There is often a large disparity between production cost and the selling price in the United States, with much of the difference ending up in the hands of foreign and domestic shippers, wholesalers, and retailers.<sup>56</sup>

The extent to which consumers benefit from inexpensive imports is obviously a controversial issue, one that is difficult to resolve given the lack of appropriate data. However, figure 15 suggests that changes in domestic apparel prices are not closely correlated with changes in import prices; this can work both for and against the interests of consumers. The price of imports appears to have increased much more sharply than average domestic sales prices from 1977 to 1982, and has roughly followed domestic prices since then. Presumably, three factors cause the increase in import prices:

1. a shift in mix, not captured properly in the deflator series that compute price indices;
2. real increases in production prices abroad, due to rising wages and other factors; and

<sup>54</sup>Ibid.

<sup>55</sup>Joyce Santora, “Retailers Reassess Domestic Sourcing,” *Bobbin Magazine*, April 1986, p. 63.

<sup>56</sup>Murray Finley, president, Amalgamated Clothing and Textile Workers’ Union, cited in *AFL-CIO News*, Nov. 23, 1985, p. 1.

Figure 15.—Price Indices for Clothing (1982=1)

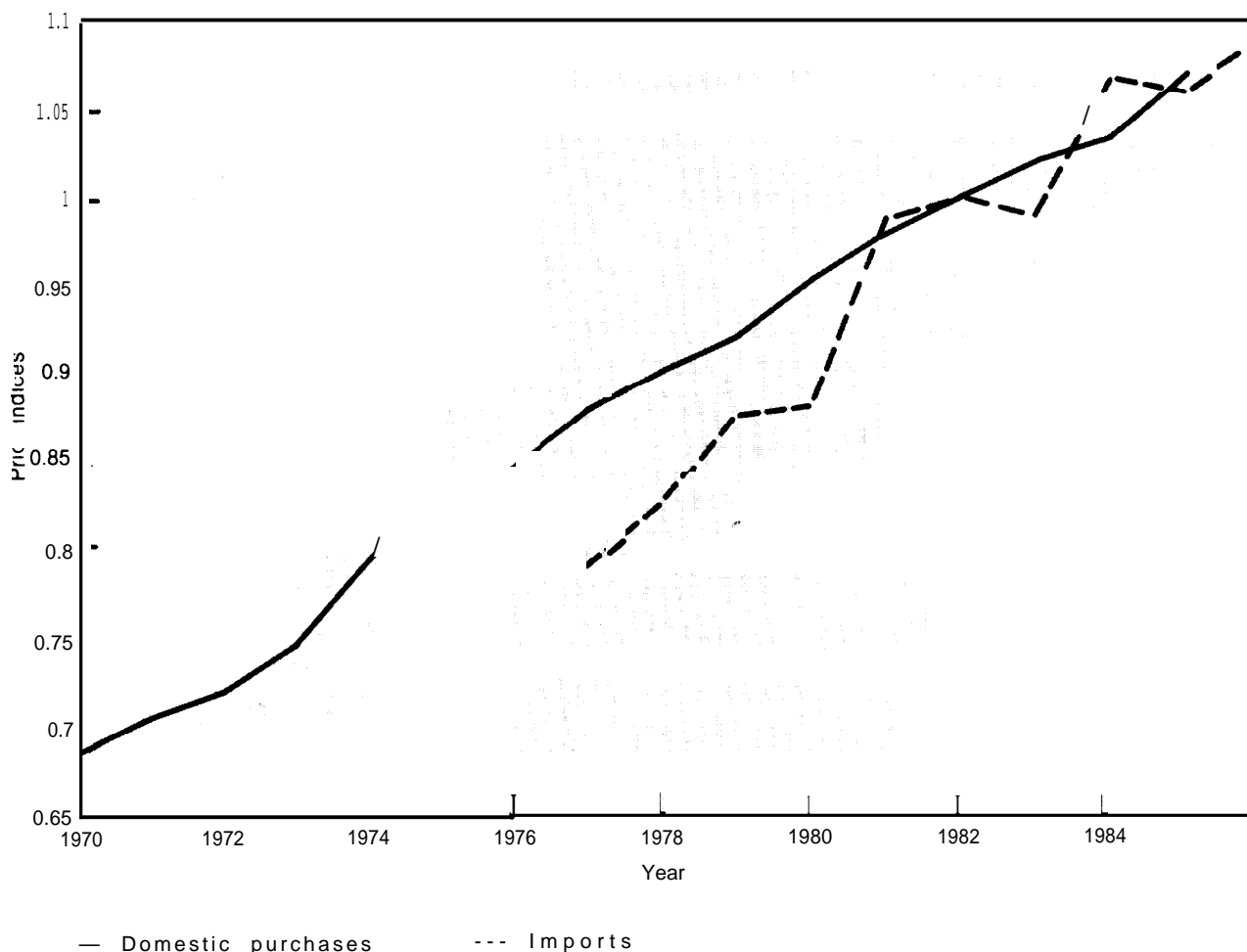

SOURCE Office of Technology Assessment, 1987; based on data provided by the U S Department of Commerce and U S Department of Labor

### 3. shifts in the way markups are captured here and abroad.

The Fiber, Fabric & Apparel Coalition has used Commerce Department figures to show that many imported blouses, shorts, and shirts actually cost more than their U.S.-produced counterparts.<sup>57</sup> John Meinert, president of the Clothing Manufacturers Association, testified in 1985 before a subcommittee of the House Ways and Means Committee about the financial advantages of clothing imports benefiting retailers, not consumers. He told the subcommittee:

It is no secret that a big attraction of cheaper imported goods is the exceptional mark-up available to

<sup>57</sup>AFL-CIO News, Nov. 23, 1985, p.1.

be taken by retailers. It is argued that such low-base pricing is passed on to American consumers through lower prices. That argument has been demonstrated incorrect. The high margins available on these imported goods are used to benefit those who import them, as the differential is retained by the importer-seller. The American consumer does not receive lower prices, and we know this to be true from our information about companies which compete in our retail markets.<sup>58</sup>

In addition, some have charged that in those cases where the consumer does benefit from a lower price

<sup>58</sup>Testimony of John Meinert regarding HR-1 562, "The Textile and Apparel Trade Enforcement Act of 1985," Subcommittee on Trade, Committee on Ways and Means, US. House of Representatives, July 15, 1985, p. 2.

on imported apparel, it is often the result of misleading “discount” prices. Some retailers may mark up the price of their imported garments to match the price of a similar U.S. garment, only to immediately discount the initially advertised cost. In this way, the retailer can still make a profit far above that which would be earned from sale of the U.S. garment, while gaining the added marketing advantage brought by advertising a discount.

When Allied Stores president Thomas Macioce was asked by Women Wear Daily whether retailers are really buying markups when they purchase imports, his response was: “Sure, we are indeed buying better markup, but that’s our job. We would be delighted to buy only American-made goods if we could make the same type of markup.”<sup>59</sup>

A study by the Amalgamated Clothing and Textile Workers’ Union (ACTWU)<sup>60</sup> found three foreign-made shirts, from Taiwan, Guyana, and Colombia,

<sup>59</sup>Testimony of Sol Chaikin, President, International Ladies’ Garment Workers’ Union, Subcommittee on International Trade, Committee on Finance, U.S. Senate, July 15, 1985, p. 13.

<sup>60</sup>*AFL-CIO News*, Oct. 5, 1985, p. 1.

with the same \$18 price tag as an identical U.S.-made shirt. Similarly, a comparison of the costs of men’s long-sleeve broadcloth shirts found the following. The wholesale cost of the U.S.-made shirt was \$6.50, and a 100 percent retailer mark-up yielded a \$13 retail price. The cost of the same shirt made in Korea was \$4.25, including labor, shipping, and tariffs; a 206 percent markup was added to this shirt, or \$8.75, so that the Korean shirt sold for \$13 as well. For every imported shirt sold at the retail price, the retailer made an additional \$2.25. On an annual basis, ACTWU found that the retailer imported 250,000 dozen shirts, for a total additional profit of \$6.75 million. A study by the International Ladies’ Garment Workers’ Union indicates that “markups on imported garments typically range from 200 to 400 percent.”<sup>61</sup>

It is important to note that many U.S. retailers dispute this analysis strongly. They argue that markups on inexpensive imports are not nearly large enough to deny the U.S. consumer the benefits of low-cost imported apparel.

<sup>61</sup>Letter from Dr. James Parrott to OTA, *op. cit.*, p. 5.

## THE ADEQUACY OF DOMESTIC INNOVATION AND CAPITAL INVESTMENT

### ***Research and Development***

While improved R&D efforts alone will not ensure a healthy domestic industry, they are clearly necessary. There are indications that U.S. efforts in R&D related to textiles and apparel may not be adequate, given the high social returns that could be enjoyed from a healthy domestic industry. Even more important than the development of new inventions, however, is the creation of an economic and management environment that allows American entrepreneurs to make money from investment in innovation. This requires capital and, in many cases, more patience in waiting for returns than has been typical of U.S. investors operating under existing macroeconomic policy.

It is ironic that while many U.S. economic problems have resulted from an inability of U.S. investors to capitalize on the benefits of innovations developed in the United States—most of the basic

inventions behind semiconductors were developed in the United States, for example, yet it is the Japanese who seem to be succeeding in turning these inventions into profits—in the textile and apparel industries the reverse may be happening. Much of the technology that has made the U.S. textile industry among the most productive in the world has been purchased overseas.

Large companies do carry out some of their own R&D, especially the chemical companies that produce synthetic fibers. But in an industry that to date is still made up largely of small, family-owned companies, it is difficult to amass the capital for major technological research. Most of the R&D for textile equipment is done by the equipment manufacturers, but little in the way of major innovation has come in recent years. The electronics and other related industries are, of course, engaged in R&D related to computers and electronics, that can be adapted to the textile and apparel industry.



Even though the new surge in investment in plant and equipment preceded the flood of imports, it is the decade-long explosion of textile and apparel imports into the United States that has served as the greatest impetus for restructuring. Many look toward promoting U.S. technological developments as a major response to the threat of those imports. All agree that at a minimum, the United States must keep pace with technological developments that are constantly occurring throughout global markets.

R&D is critically needed to improve technology, but also to make strides in organizational structure, marketing, and public policy. As the chemical industry becomes increasingly aligned with the textile industry, some segments—most notably fibers—have experienced greater R&D efforts. The U.S. chemical industry has long understood the need for aggressive R&D efforts, accounting for 9 percent of U.S. manufacturing shipments but approximately 15 percent of all industrial R&D and 35 percent of all research funded by industry.<sup>62</sup> Du Pent chairman E.G. Jefferson credits this level of R&D with assisting the chemical industry in achieving a \$9 billion trade surplus and generating 36 percent of world chemical sales in 1983.<sup>63</sup> Fiber research at Du Pent has given way to process technology advances, responsible for more than doubling productivity in manmade fibers during the past decade.<sup>64</sup>

Rapid technology transfer around the world is a simple fact of life. It takes the form of exported products, industrial processes, and the skills needed to apply technical ideas. Driving costs down through investment in nonproprietary technology cannot prevent long-term, continued growth of imports.<sup>65</sup> But many argue that it can provide an important short-run technological and competitive edge.

There is evidence that the pace of technological diffusion is increasing. Technological innovations are themselves a major contributor to the trend. On-line international data networks allow global access to current information in some areas, while new tele-

communications increasingly permit tighter global integration of production and even R&D. More generally, declining communications and transportation costs have contributed to an increase in the knowledge and skill base outside the United States, a development visible in the rapid growth of trained engineers, financial experts, and managers in developing nations. The result is a more competitive economic environment, in which the life cycle of any product has been dramatically shortened.

### **Capital Investment: An Economic Necessity**

Textile executives realize that their companies must modernize if they are to survive. But with machinery turnover and the period of renewal of machinery growing more rapid from year to year, demand for capital investment funds can be staggering. The degree of technological change in the industry requires constant investments to keep up with competition. Some of the larger textile firms, like Burlington Industries, have been investing as much as 85 percent of their cash flow in new machinery.<sup>66</sup> The U.S. textile industry has spent \$1 billion or more a year on machinery for two decades, and is the most productive in the world.<sup>67</sup>

One of the costs of the scale of investment needed for new technology may be the increasing concentration of the industry, as only large and financially strong corporations may deem themselves able to absorb the costs. In weaving, for example, the 10 largest companies in the United States account for 85 percent of all purchases in new machinery. It is unclear if weaker firms are able to afford the constant renewal process demanded by rapidly changing technology. While substantial capital investments are essential to achieving a competitive edge in productivity, clearly relating these investments to short-run profitability is often difficult. An example of this was explained by a Du Pent Vice-President in the following way:

Our Cooper River plant near Charleston, S. C., is our newest, largest and most productive facility for the manufacture of polyester staple and filament. It

<sup>62</sup>Remarks of E G Jefferson, Chairman, Du Pent, at the 40th Anniversary of the Society of Fiber Science and Technology, Tokyo, May 11, 1984, p 5

<sup>63</sup>Ibid

<sup>64</sup>Ibid, p 6

<sup>65</sup>Peter Harding, Kurt Salmon Associates, Inc, "Quick Response in the Soft Goods Pipeline," synopsis of speech given at the Knitted Textile Association Retail Relations Workshop, Dec 6, 1985, p. 1,

<sup>66</sup>W.E. Schmidt, op. cit.

<sup>67</sup>Fiber, Fabric & Apparel Coalition for Trade, "Fiber, Textile and Apparel Imports: Myths and Realities," Mar 14, 1985,

started up in 1976. The mid-1980s cost to duplicate this large modern facility will be almost double our original mid-1970s investment. We're talking about hundreds of millions of dollars. A return of 15 percent would be the minimum required to invest in such a plant in this decade. Prices for polyester will need to rise more than cost escalation to make reinvestment in polyester staple an attractive business opportunity for us in 1985.

Clearly, that's a formidable challenge when prices are not even at the point of meeting our past cost increases.<sup>68</sup>

Investment requirements in the industry are by no means spread evenly among sectors. The traditional apparel sectors have only 14 percent of the overall fixed assets of the industry. The weaving, knitting, and yarn sectors, on the other hand, have 55 percent of the overall fixed assets. Within fabric production, cotton fabric manufacture requires the highest fixed assets.

<sup>68</sup> M.D. K. Barnes, Vice president, Textile Fibers Department, Du Pont, "The Fibers Outlook," report to American Apparel Manufacturers Association Seminar, New York, Dec 10, 1980, p. 9.

While there appears to be a commitment to modernization, the degree of investment depends largely on the current economic situation. Purchases of shuttleless looms and ring spindle frames fluctuate heavily with the economic climate. This, however, has not been true with open-end spinning machines. And while U.S. firms are investing substantially, the ratio of new technology to older technology is still rather small, and some industry experts question the long-term commitment of manufacturers to make the necessary investments.

Due to a high gross value of fixed assets as well as a high turnover of machinery, the weaving segments of the textile industry alone account for 29 percent of total yearly expenditures on new plant and equipment. Apparel firms spend much less on new equipment, largely because there have historically been few technologies designed to increase the productivity of apparel manufacturing. As chapters 2 and 3 indicated, however, this situation may change rapidly in the near future, through the adoption of Quick Response technologies; U.S. apparel firms may soon have to make significant new investments in production equipment in order to remain competitive in world markets.

## IMPLICATIONS FOR THE TEXTILE AND APPAREL LABOR FORCE

Advancing technology and the internationalization of production are revolutionizing employment in the U.S. textile and apparel industry. The total number of jobs continues to decline, while new jobs are frequently created in unconventional categories.

The textile industry throughout U.S. history has been, and in the 1980s continues to be, a major industrial employer. The U.S. textile industry complex—consisting of fiber, textile, and apparel production—is the Nation's largest nondurable goods manufacturer, and employs one in every nine manufacturing workers, or just under 2 million in 1985. Apparel is the largest employer, with 1.1 million employees. Textile mill products follow with 700,000 workers. In the fiber industry, man-made fiber production employs 64,000 individuals. The textile machinery industry, a durable goods sector, employs 18,000.

With 2 million people employed in all 50 States, and 1983 wages totaling nearly \$25 billion—\$1 1.1

billion for textile wages, and \$13.6 billion for wages in the apparel sector—major changes in the number and types of textile jobs affect more than just specific individuals and companies. Many workers live in communities in which a textile plant is the only major local employer; job losses in these areas affect both States and localities, since both suffer from the depletion of economic activity and the loss of tax revenue caused by high unemployment. Clearly, such effects may propagate through the U.S. economy as well.

### ***Employment Changes Within the Industry***

#### Sectoral Shifts

In apparel, labor-intensive operations still predominate in the industry, and job declines are largely due to import penetration. The apparel sector em-

employs 48 percent of the total industry, and has the lowest wages—27 percent lower than manufacturing as a whole, and 13 percent lower than those employed in textile mill products manufacture. It also has the greatest percentage of women employees of all manufacturing sectors, 81 percent. In addition, apparel has the largest percentage of production employees to total employees, 82 to 84 percent v. 70 percent for all manufacturing. Apparel is also the sector of the industry where job loss is most severe, especially low wage production jobs filled by substantial numbers of women and minorities.

In textile mill products, automation and adoption of new, capital-intensive technology have significantly reduced the number of jobs available. Indeed, there are many examples of modernization eliminating jobs. Since 1978, when Burlington began its modernization program, it has reduced its work force by at least 10,000. Stevens has spent more than \$480 million on its capital program since 1978, and, like Burlington, has trimmed 10,000 people from its payroll.

But modernization does not always lead to job loss—especially if new plant and equipment can be used to expand markets. When Burlington replaced 700 Draper fly shuttle looms in its Shannon, Georgia, plant with approximately 450 Ruti air-jet looms in 1979, none of the 1,300 employees there were laid off, even though production speeds increased two- to three-fold. At the Burlington weaving plant in Vinton, Virginia, when a \$25 million modernization program in 1981 converted operations to shuttleless weaving, the 600-employee work force was fully maintained.<sup>69</sup>

Within the textile mill products sector, the distribution of employment varies considerably among production processes. The weaving sectors, for example, account for 16 percent of all employees in the total textile industry. Knitting and hosiery account for 10 percent of industry-wide employment, the yarn industries 5.5 percent, and the carpet industries 2.4 percent. All other sectors employ less than 2 percent; 2 percent, however, still represents 50,000 jobs.

The only industry sector claiming new job creation was retail trade, which gained nearly 250,000

jobs between 1970 and 1985. This was largely due to the sharp rise in personal spending on apparel after 1970, which necessitated more activity at the retail end of the industry. However, a gain in retail jobs in the service sector of the economy may not help stop the erosion of the U.S. industrial base, especially when an increasing share of what U.S. consumers purchase has been manufactured overseas.

In addition, these jobs provide substantially lower average wages than textile manufacturing jobs—themselves low-paying by U.S. industrial standards, although not by international standards for textile and apparel workers. Average 1985 hourly earnings in apparel retail trade were \$5.29, in contrast to \$5.73 for apparel manufacturing, \$6.71 for textile mill products manufacturing, and \$7.98 for textile machinery manufacturing. In the newer manmade fiber industry, however, wage rates were significantly higher, with average hourly wages at \$11.37.70 These compare to an average hourly rate in 1980 for all manufacturing of \$8.55.

### Job Movement to Overseas Production Facilities

Much employment has been lost as textile companies transfer some of their production overseas.

<sup>70</sup>U.S. Department of Labor, Bureau of Labor Statistics, *Employment and Earnings*, March 1986, pp. 91-93



Photo credit Copyright (©) 1986, 1987 by Bobbin International, Inc.  
All rights reserved

This apparel manufacturing facility, located in Barbados and used by U.S. firms under the 807 role, employs a low wage workforce. The lower labor costs that a U.S. firm pays to these workers often influence the choice to move labor-intensive tasks offshore.

<sup>69</sup>*TextileWeek*, Aug. 10, 1981, p 6

While such activities may deplete a region's economic base and tax revenue due to the loss of jobs, some analysts claim that this is balanced by the fact that overall corporate costs are minimized when labor-intensive tasks, such as sewing, are performed in low labor cost countries. However, as the level of technology and the capital intensity of production grows, wage rates may decrease in importance. The education of the people at the machines and in the control rooms may gain increasing priority,

It is important to note that the United States is not alone in suffering employment losses in the textile and apparel industry. Job loss has occurred throughout the developed world—for example, 53 percent in the Netherlands and 37 percent in the United Kingdom within the last decade. At the same time, employment in developing nations is gaining significantly—11 percent in South Korea and 194 percent in Mauritius, for example.<sup>71</sup>

### ***Impact on Individuals and Families***

The textile industry is an important employer of women and minorities. While manufacturing overall had an employment profile that was 32 percent female in 1980, it was 51 percent for the textile industry. Whereas minorities held 11 percent of manufacturing jobs overall in 1980, they represented 20 percent of textile manufacturing employment.

The industry is also a major employer of immigrants, and immigrants feel dependent on these jobs. For example, in testimony before the Congressional Textile Caucus, one Chinese member of the ILGWU said that except for the garment shops, there were almost no places outside Chinatown where a non-English speaking immigrant could find work in New York City.<sup>72</sup>

In many cases, there may be little or no severance pay to displaced workers. Because of the low level of wages, it is unlikely that a displaced individual has much in the way of savings.

The damage that job loss brings to individuals and families can be significant; problems are exacerbated

for two main reasons. First of all, many of the workers affected are minorities, women, and/or those with little education and few other job skills. Second, they often live in areas that are highly dependent on textile and apparel employment. Displacement may mean not only the uprooting of individuals and families, but of whole communities and regions as well.

### ***Impact on Communities and Regions of the Country***

The geographical distribution of textile employment makes the industry, both as an employer and as a tax-paying resident, critical to several regions of the United States. As of 1980, 46 percent of U.S. textile employees were in the Southeast, and 17 percent in the Midwest; the latter were predominantly agricultural workers involved with cotton and wool fibers. North Carolina houses over 250,000 textile jobs, more than any other State. South Carolina, New York, and Texas each have between 200,000 and 250,000 people employed. Georgia and Pennsylvania rely on the textile industry to supply between 150,000 and 200,000 jobs. And there are between 100,000 and 150,000 textile jobs in Alabama, California, Tennessee, and Mississippi (see figure 16).

Jobs are divided about half and half between small towns and metropolitan areas. In South Carolina, for example, approximately 60 percent of all textile and apparel jobs are in places with fewer than 2,500 people. But textile and apparel businesses are also significant employers in New York, Philadelphia, Los Angeles, and Miami.

It is conservatively estimated that for every U.S. textile worker who loses a job, another American worker is also put out of work (see tables in the executive summary). These connections are particularly vivid when entire communities are affected by loss of a major plant.

Indeed, in geographic areas where textile employment is particularly concentrated, such as the Southeast, plant closings and job loss can mean economic devastation to an entire town or region. The decline in employment has been the greatest in North Carolina, South Carolina, New York, and Pennsylvania. The region of the country most directly affected is the Southeast—North Carolina, South Carolina, Geor-

<sup>71</sup>International Labor Organization, "Social and Labor Practices of Multinational Enterprises in the Textile Clothing and Footwear Industries," cited in *Daily Labor Report*, Bureau of National Affairs, Jan. 3, 1985, p. A-6.

<sup>72</sup>*AFL-CIO News*, Sept. 21, 1985, p. 5.

Figure 16.— The Geographic Distribution of Textile Employment by State

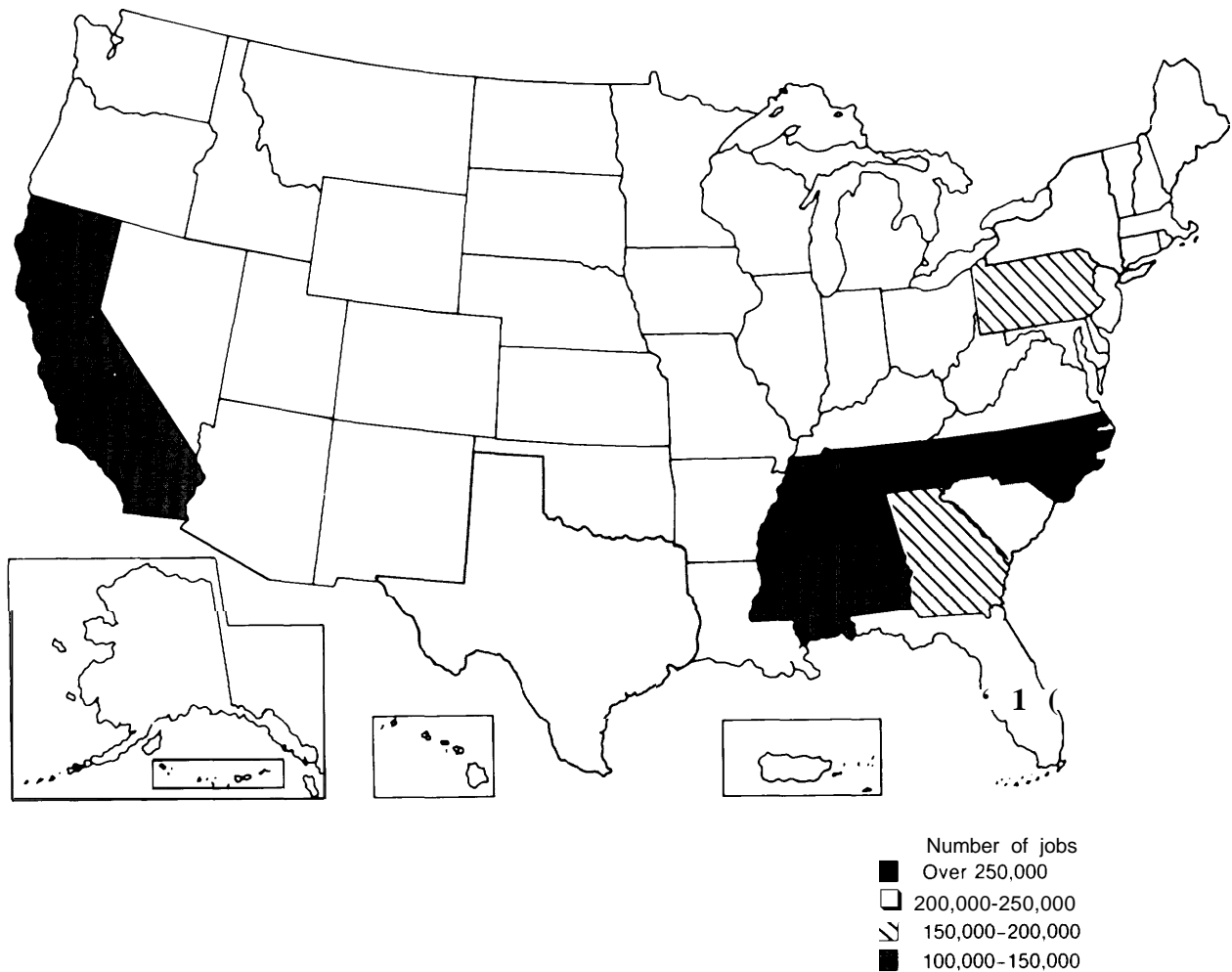

SOURCE Office of Technology Assessment, 1987

gia, Tennessee, Alabama, Florida, Kentucky, and Mississippi—where 33,400 jobs were lost in 1985, bringing textile employment 17 percent below its 1951 level. According to the Bureau of Labor Statistics, 32.2 percent of the region's total manufacturing employment in 1951 was in the textile industry. By 1985, it had shrunk to only 13.5 percent.<sup>73</sup>

An example of economic devastation to a small textile town is Ware Shoals, South Carolina—a town built by Riegel Textile Corp. nearly 80 years ago, and now the location of a closed textile plant. Ware

Shoals has a skilled work force, an abundant water supply, an adequate waste treatment facility, and nearly 1 million square feet of manufacturing space under one roof. The town has access to rail and major highways, and to airports in Greenville and Greenwood.

Ware Shoals also has severe unemployment mortgage foreclosures, town emigration, empty stores, and an eroding tax base. Sixty percent of its businesses are gone, including all of its clothing stores. More than 50 percent of the town's property taxes were lost by the exodus of Riegel alone, not to speak of wiping out the lion's share of business license taxes. Younger people are moving out, leaving be-

<sup>73</sup>U.S. Department of Labor, Bureau of Labor Statistics, cited in AFL-CIO News, July 19, 1986, p. 3.

hind an elderly population that faces a severe cut-back in public services due to the town's eroded tax base. Beyond the tragedy of Ware Shoals is the fact that this is not an uncommon occurrence:

The story of what happened in Ware Shoals is fairly typical of what has occurred in many communities

where textile manufacturers have closed plants over the past four years. Invariably, the closing of a plant is followed by an exodus of small businesses and a virtual collapse of local economies.<sup>74</sup>

---

<sup>74</sup>Rudolph A. Pyatt, Jr., "Factory's Shutdown Tears Fabric of Small Company Town," *The Washington Post*, Oct. 14, 1985, pp. 1, 26-27.

---

**Chapter 5**

**Policy and Survival**

# Policy and Survival

Clearly, the burden of transforming the textile and apparel industries in the United States lies with the thousands of private investors and managers that must pilot their companies through a period of unprecedented change. This will require large amounts of capital, careful reexamination of “standard operating practices,” continuous innovation, and taking some significant risks. Perhaps most importantly, building a competitive industry will require confidence on the part of investors. Public policy, however enlightened, cannot replace such factors.

On the other hand, while the previous discussion indicates that many parts of this industry have moved boldly to build a world-class enterprise, their efforts alone may not prevent major sections of the industry from being eliminated by low-cost imports. Federal action could assist the industry in a variety of ways. The government can foster an economic climate conducive to risk-taking and innovation. It can help firms to retrain workers as production techniques change. It can protect the domestic industry against unfair trading practices by foreign firms. And it can act to stem the excessive tide of imports while the industry works to rebuild itself.

Debate over possible Federal programs in these and other areas has been long and complex. The

following discussion will not resolve disputes covered more extensively in other, more detailed industry analyses. Rather, it will outline areas where Federal action has been suggested by a variety of groups involved in the production and trade of textiles and apparel.

Consensus about appropriate policy directions for the textile and apparel industry is difficult to achieve. In addition to basic disagreements about economic philosophy, complex industry interests are involved. For example, retailers may care little about domestic manufacturing if their foreign sources are viewed as secure; they would argue that the consumer benefits from low-cost imports. Some go so far as to contend that the United States does not appear to have a comparative advantage in many textile and apparel activities, and should not attempt to prevent the inevitable—rather, they argue, emphasis should be placed on industries in which U.S. firms can more easily compete in international markets. U.S. textile and apparel manufacturers and unions take strong exception to this perspective, and state that their industry can remain a major employer—given appropriate protection in the short term, and adequate support for research and investment over the long term.

## EMPLOYMENT ISSUES

Because the textile and apparel industry is so labor-intensive—especially the apparel segment—any severe negative impact on the industry’s employment becomes a problem of national concern. While some private firms have taken steps to facilitate the transition, several proposals have been suggested for public sector action, and some Federal programs already exist. What follows is a brief discussion of Federal programs to facilitate job transition and training.<sup>1</sup>

<sup>1</sup>For more detailed discussion of this subject, see U.S. Congress, Office of Technology Assessment, *Technology and Structural Unemployment Reemploying Displaced Workers*, OTA-ITE-250 (Washington, DC: U.S. Government Printing Office, February 1986).

### ***Assistance for Textile and Apparel Workers***

Currently, it appears that the majority of textile and apparel firms devote few resources to helping workers who have been displaced—whether the assistance comes in the form of advance notice of a plant closing, or actual help in retraining and relocation. Data on assistance to displaced workers are not available, but there is little reason to believe that textile and apparel workers receive more help from their ex-employers than the average displaced worker. A survey done by the U.S. General Accounting Office, *U.S. Business Closures and Permanent Layoffs During 2983 and 2984*, indicated that of U.S. com-



panics employing more than 100 people, only one-fifth gave placement help to blue collar workers, and that the average blue collar worker received 7 days' notice of a plant closing. As an OTA special report has concluded, "notice periods this brief do not allow enough time to prepare an effective program of adjustment assistance for the displaced workers."<sup>2</sup>

Should companies be required to give employees advance notice of pending job losses, as is done in several European countries? Should severance pay be required? Should there be any direct responsibility of the company to seek out new job opportunities actively, either through enticing new businesses to the affected community—perhaps to the very buildings abandoned by the departing firm—or by searching out appropriate job opportunities for their employees in other locations? Such questions affect not only the textile and apparel industry, but all U.S. industries; two recent OTA reports provide detailed discussion of programs for advance notice, job transition, and job training.<sup>3</sup>

Some of the larger textile firms have relocated displaced workers from one company plant to another. For example, Fieldcrest Cannon, Inc., attempts to relocate laid-off employees at other company sites when practical, according to O.L. Raines Jr., the company's vice president of human resources. This firm also notifies area employers and State employment officials in order to gain further reemployment assistance, and has provided advance notice of a plant closing—in March 1986, Fieldcrest announced that it was laying off 1,465 workers in North Carolina and Georgia; the layoffs began midyear. But, says Raines, "We don't have the resources to do as much . . . as we'd like."<sup>4</sup>

Even more than textile companies, many apparel firms suffer from a lack of resources to devote to worker transition. A small apparel job shop may depend on orders from larger firms, and may be unable to project the amount of work to be done in a few weeks, much less the several months needed to develop comprehensive worker adjustment plans.

<sup>2</sup>U.S. Congress, Office of Technology Assessment, *Plant Closing: Advance Notice and Rapid Response—Special Report*, OTA-ITE-321 (Washington, DC: U.S. Government Printing Office, September 1986), p. 1.

<sup>3</sup>*Technology and Structural Unemployment: Reemploying Displaced Adults*, op. cit., ch. 5; *Plant Closing: Advance Notice and Rapid Response—Special Report*, op. cit., pp. 26-27.

<sup>4</sup>*The Charlotte Observer*, Apr. 28, 1986, p. 17C.

Accordingly, many proponents of advance notice support a "size qualification," whereby firms under a certain size would not have to satisfy all of the requirements that larger, more capital-intensive firms could fulfill.

In the United States, only Maine and Wisconsin require advance notice, while only three other States have laws that provide for voluntary advance notice. However, none of these States are located in the Southeast, where most U.S. textile and apparel firms reside. And it is uncertain whether those States that do have laws have actually improved their own programs for displaced workers, since very little data has been collected on the effects of these laws. Moreover, enforcement has been only modest.

Aside from advance notice, several States have other laws related to plant closings. Some, for example, require that employers continue health insurance coverage for a period of time. Some offer technical and financial assistance for worker buy-outs, and some give assistance to troubled firms to help them stay in business,

Some State officials argue that the private sector is acting effectively to meet the needs of displaced workers, asserting that today's textile firms have "demonstrated a lot more empathy than . . . in the past. Most of the companies make a good effort to help their employees."<sup>5</sup> While there are models of excellent company programs, these are generally the exception and not the rule for U.S. businesses. As the Secretary of Labor's Task Force on Economic Adjustment and Worker Dislocation recommends, "greater private sector effort is necessary to alleviate the problems faced by displaced workers and their communities."<sup>6</sup>

Skill upgrading by companies is another question. Some argue that the production and management jobs of the future will require entirely different skills. They contend that more education and different training will be needed to perform on the job. Beginning some of that retraining now, with existing employees, could help ease the displacement crisis that is likely to continue in the industry. It is important to note, however, that these kinds of activities

<sup>5</sup>Robert Smith, assistant deputy executive director, South Carolina Employment Security Commission, cited in *The Charlotte Observer*, op. cit.

<sup>6</sup>*The Charlotte Observer*, op. cit., p. 6.

may benefit society as a whole more than the industry that helps fund retraining programs. As a result, company-based retraining efforts may often fall short of a level that would be optimum for the Nation.

### ***State and Local Responsibilities for Employment Training and Transition***

Communities whose tax and economic bases depend heavily on the production of textiles and apparel have a clear interest in ensuring that new employment opportunities respond to plant closings, and that individuals who must navigate the transition to new jobs have access to assistance programs. As textile and apparel firms continue to adapt to new technologies and changing market conditions, local social service departments may be forced to increase the money and time allocated to assist displaced workers and their families.

Active promotion of potential businesses by communities, as well as by regional and State bodies, has proven successful in many areas. Lowell, Massachusetts, for example, has lost many textile and apparel jobs over the past 50 years, but in recent years the town has recruited several high-technology firms to its community, including Wang. These firms have provided employment opportunities directly through the job openings they offer, and indirectly through the economic stimulus that their presence brings to the town. North Carolina's Research Triangle Park has also provided some relief to those in the State left unemployed by plant closings or layoffs in the textile and apparel industry.

In order to retain existing firms or lure new firms to their communities, a local body may have to waive or reduce property taxes for a period of time. Infrastructure may have to be provided at public expense. Local governments may have to go to their citizens with new bond issues. These kinds of expenditures can help slow the drain on public services resulting from widespread worker displacement—services which range from State unemployment insurance to local programs providing emergency shelter for a family evicted due to insufficient mortgage or rent payments. The competition among communities to attract industry is high. But so are the stakes to communities and their residents—and to States, which stand to increase their tax base significantly during times of high employment.

There is, however, a limit to actions that a State or city can take in order to bring industry into its borders. Some States are threatening to bring suit against businesses that have been granted special incentives, but have then fallen short of fulfilling original expectations. One 1984 study found that “for every 50 cents difference that an incentive made in a company's profit, it cost a State \$1 in foregone revenues.”<sup>7</sup> Clearly, too much in the way of up-front company bonuses can cause the State or locality to lose more revenue than would be gained through long term industrial activity. Moreover, some businesses have admitted that prospective subsidies play a less important role in a location decision than such factors as a reputable labor force, a natural resource base, and even “quality of life” considerations.<sup>8</sup>

### ***Trade Adjustment Assistance***<sup>9</sup>

The Federal Government, through the Trade Act of 1974, has provided “trade adjustment assistance” (TAA) to workers who lose their jobs due to foreign competition, and to firms who suffer from increases in imports. TAA was established to aid in the orderly transfer of resources to alternative uses, and to help with adjustments to new conditions of competition. Trade-affected firms can also receive technical assistance from the International Trade Administration of the Department of Commerce.

Workers qualify for TAA funding through certification by the U.S. Department of Labor. The law requires certification in 60 days, but delays have been frequent. With recent improvements in the process, about half the petitions now receive a decision within the 60-day legal mandate.

Once certified as having been displaced due to the effects of trade, workers are eligible to receive Trade Readjustment Assistance (TRA), or weekly income support payments. Through 1981, these payments were made over and above any payments made through State unemployment insurance (UI); since that time, however, TRA has been tied directly to UI. Workers may now receive TRA and UI payments combined for one year, and TRA must be at the same

<sup>7</sup>Alex Kotlowitz and Dale D Buss, “Localities' Giveaways To Lure Corporations Cause Growing Outcry,” *The Wall Street Journal*, Sept. 24, 1986, p.1.

<sup>8</sup>Ibid.

<sup>9</sup>This section is based largely on *Technology and Structural Unemployment: Reemploying Displaced Workers*, op. cit., pp. 196-198

### Box C—Current Federal Programs for Job Transition\*

**Title III of the Job Training and Partnership Act of 1983 (JTPA)** responded to renewed concern about displaced workers. JTPA's Title III helps displaced workers to train for, and find, new jobs, through programs that are generally directed by State Governors. Title III calls for the States to determine exactly what services will be provided, how, by whom, and for whom. Title III programs will be supported by Federal funding of \$223 million in fiscal year 1987, plus some matching contributions by States. Title III serves approximately 120,000 workers per year.

**The Employment Service (ES)**, created by Federal law during the Great Depression, is the oldest government service available to displaced workers. Essentially, ES is a job brokering service, matching jobseekers with requests from employers. ES can also offer counseling, testing, assessment, and "job development," or unearthing jobs that are not yet listed. However, ES never actually provided these services for more than a small minority of clients, and recent cutbacks of staff and funding have curbed ES services still further.

**Unemployment Insurance (UI)**, administered by ES offices, is designed to provide temporary income replacement for workers who have lost their jobs through no fault of their own. Regular UI benefits last 26 weeks, and can be extended another 13 weeks when a State's "insured unemployment rate"—that percentage of a State's workers covered by UI who are actually collecting benefits—is high. UI's two main objectives are to provide a cushion for unemployed workers between jobs, and to help stabilize the economy in recessions. UI can also provide a source of income for displaced workers while they learn job search skills or retrain for a new occupation.

\*This information is drawn from U.S. Congress, Office of Technology Assessment, *Technology and Structural Unemployment: Reemploying Displaced Adults*, OTA-TTE-250 (Washington, DC: U.S. Government Printing Office, February 1986), ch. 5.

level as UI. While receiving this support, workers can take advantage of considerable retraining and relocation assistance—ranging from reimbursement of 90 percent of out-of-area job search expenses (up to \$800) to subsidized "on-the-job training" in new jobs. Workers enrolled in approved classroom training can continue to receive TRA payments for an additional 26 weeks after 1 year has expired.

TAA benefits were cut back sharply in the first half of the 1980s. Outlays for TRAs dropped from \$1.6 billion in fiscal year 1980 to \$35 million in fiscal 1984. In December 1985, Congress failed to pass legislation that would have reauthorized the program (the Omnibus Budget Reconciliation Act). However,

funding for TAA services to workers was extended. No provision was made at the time for TRAs.

In April 1986, a 6-year extension of the TAA program was approved, retroactive to December 19, 1985. TAA outlays were about \$146 million in fiscal year 1986, including \$118 million for TRAs. Government estimates of outlays for fiscal year 1987 forecast a total program expenditure of over \$200 million. These levels are similar to those of the 1970s.

In addition to TAA, box C describes several other Federal programs for job training and transition.

## TRADE ALTERNATIVES

In the arena of public policy, no issue is as important to the future of the U.S. textile industry as trade. But the specifics of a coordinated trade strat-

egy are the subject of debate. If the United States wishes to gain greater access for domestic producers in the protected markets of other countries, it

could announce that retaliatory measures will be taken unless foreign trade barriers are lowered. Such an approach, however, must be weighed against the fact that any effort to gain trade concessions for U.S. textile and apparel firms—by either increased protection of domestic markets or pressure to open foreign markets—is likely to affect trade negotiations in other areas.

Most experts agree that programs designed to revitalize U.S. textile and apparel firms will probably have little impact without a trade strategy that gives the industry time to complete its massive restructuring. On the other hand, many economists oppose the principle of trade protection, and contend that if such action must be taken, it should be in the form of temporary tariff increases. Tariffs, they argue, are preferable to quotas and other nontariff mechanisms—tariffs make the cost of trade restrictions clear to consumers, and the revenue from tariffs goes to the U.S. treasury, not to foreign exporters who may react to quotas with higher prices.<sup>10</sup>

Where the U.S. Government has intervened in textile and apparel trade, its interventions have tended to be ad hoc and reactive rather than comprehensive. While most major textile and apparel producing nations have implemented sectoral industrial policies—featuring industry promotion subsidies and import protection—the U.S. Government has played a comparatively passive role, seeking to patch up particular problem areas as they develop rather than implement a more systematic approach. And, as indicated in chapter 4, many charge that existing trade regulations concerning textiles and apparel have been ineffectively implemented.

The surge of textile and apparel imports into the U.S. market is a reflection of an export drive by developing nations trying to bolster their domestic economies, and of a defensive response by a number of industrialized nations. The impetus for these developments has been provided by foreign governments. [If the United States fails to address this problem, much of the future of U.S. textile and apparel industries may be determined by decisions in other countries.

## **Export Promotion**

U.S. textile exports have never been a significant part of domestic production, and most experts would agree that they are unlikely to emerge as the major answer to the current crisis in U.S. textile trade. Nevertheless, there is growth potential for the U.S. textile industry in export markets. In 1986, U.S. textile and apparel exports increased 11 percent to about \$3.47 billion; textile products accounted for approximately 75 percent of the total value of these exports, and for about 60 percent of the increase.<sup>11</sup> It must be emphasized, however, that a substantial amount of this growth was due to 807 trade—where U.S. firms move early stages of production overseas and then reimport the final product, on which is placed a tariff that applies only to the value added outside the United States.

One way for most textile and apparel firms to improve their viability is to be sure that they share in the growth of worldwide demand for textiles. Textile firms must focus attention on penetrating foreign markets, but they will likely need the help of the U.S. Government to seek reductions in such restrictions as nontariff barriers, import licensing tactics, and 200-percent duty rates. Of course, any U.S. proposal in this area may be met with counterdemands concerning existing U.S. trade barriers in textiles and apparel and other industries, and may raise questions pertaining to past and present U.S. policies toward international exchange rate fluctuations.

Proposals and actions to promote exports include the following:

- 1 In 1979, the United States initiated a long-run program to promote textile and apparel export expansion. Implemented by the Office of Textiles and Apparel at the Department of Commerce—responsible for attempting to reduce foreign barriers to the export of U.S. textile products—in cooperation with Commerce's Bureau of Export Development, a major study of the foreign sales potential of U.S. textiles and apparel was undertaken. Textile and apparel markets in 47 countries were surveyed. A series of seminars was held in 1980, geared to the

<sup>10</sup>Robert Lawrence, *Can America Compete?* (Washington, DC: The Brookings Institute, 1984), p. 129

<sup>11</sup>American Textile Manufacturers Institute, *Textile Highlights*, September 1 1986, p. iv

needs of the manufacturers of textile and apparel products. The Department of Commerce has also examined the viability of developing U.S. export trading companies for textile and apparel products, in order to facilitate the entry of firms that think of themselves as too small or too unfamiliar with foreign trade to seriously consider exporting.<sup>12</sup>

2. In 1981, the Office of Textiles and Apparel published the known nontariff barriers to U.S. textile and apparel exports in 138 countries.<sup>13</sup> The goal was to use this publication as a basis for examining the regulations in reference to multilateral trade negotiations. The office established a special "trade facilitation" staff, charged specifically with the investigation of nontariff barriers and other trade problems encountered by U.S. textile exporters.<sup>14</sup> Such tools can strengthen the U.S. position during trade negotiations,
3. Export financing is another method of promoting exports. Because some exporters have complained that U.S. export financing for textiles and apparel is not competitive, the U.S. Department of Commerce set up a task force to study the subject.
4. The appropriate executive branch agencies could enforce existing laws and regulations that affect market access for U.S. textiles and apparel more strictly—such as Section 301 of the Trade Act of 1974, which allows the President to retaliate against unfair trade practices of other countries in world markets. However, analysis of the full value and impact of Section 301, and of possible modifications to this provision, are beyond the scope of the current discussion.
5. Another proposal is for the government to offer export subsidies to U.S. firms, in order to offset the advantages that foreign exporters receive from their governments. In the United States, this would most likely involve setting special interest rates.

## **Import Regulation**

As stated, import regulation is a contentious public policy issue, one for which many strategies have been proposed. Besides the political and philosophical debates about whether a free trade approach as opposed to some governmental involvement in trade policy is appropriate, there is also an ongoing debate about whether import protection, if developed, should be implemented as a long- or short-term strategy. The Fiber, Fabric, and Apparel Coalition for Trade laments:

In the United States, textile trade issues are too often debated in an ideological context of "free trade" vs. "protectionism." These terms have little real applicability to an industry which, at the world level, is characterized by pervasive government intervention in, and management of, the terms of trade.<sup>15</sup>

Proposals to regulate imports are numerous. They include:

1. Enacting trade legislation that could:
  - Require or encourage the President to act against foreign governments' "export targeting," or subsidization of textile and apparel exports.
  - Require or encourage the President to impose duties against "diversionary dumping," in which textiles, apparel, or textile machinery are dumped in a third country and then incorporated into a product to be exported to the United States. The European Economic Community (EEC), for example, has introduced an "antifraud" clause, which provides that fraudulent shipments may be charged against the quota of the genuine country of origin. This significantly reduced imports originating from South Korea.<sup>16</sup>
2. Enforcing bilateral agreements more rigidly. In the latest agreement with Japan, signed in November of 1986, the U.S. Government said that Japan would limit annual growth of textile and apparel exports to the United States to about eight-tenths of 1 percent; 1986 exports, however, had already grown 18 percent. In addi-

<sup>12</sup>B. Toyne, et al., *The Global Textile Industry* (London: George Allen & Unwin, 1984), pp. 113-114.

<sup>13</sup>U.S. Department of Commerce, International Trade Administration, Office of Textiles and Apparel, "Foreign Regulations Affecting United States Textile/Apparel Exports," August 1981.

<sup>14</sup>Toyne, et al., op. cit., p. 114.

<sup>15</sup>Thomas R. Howell and William A. Noellert, "The EEC and the Third Multifiber Arrangement," study prepared for the Fiber, Fabric, and Apparel Coalition for Trade, 1986, preface to Executive Summary.

<sup>16</sup>Howell and Noellert, op. cit., p. 99.

tion, when the last bilateral agreement expired on December 31, 1985, Japan assured the United States that its exports would be held at 1985 levels.<sup>17</sup>

3. Imposing tougher import restrictions. Under the terms of the Multi-Fiber Arrangement (MFA), for example, the EEC reduced access to its markets between 1982 and 1986 in 14 of 15 categories of its dominant suppliers. Also, quota provisions from MFA could be extended to fibers not currently controlled; in the agreement to extend MFA from 1986 to 1991, products of vegetable fibers other than cotton and silk blends are included as products available for quota control.
4. Limiting the growth of textile and apparel imports to the United States to the growth of the U.S. market; allowing the President to set specific quota levels within the overall total.
5. Taking action against U.S. trading partners that have developed an "excessive trade surplus" with the United States stemming from unfair trade practices, for either textiles and apparel or all trade. The definition of unfair trade could range from direct subsidies to the denial of internationally recognized labor rights and standards. One example of such retaliation might be a surcharge on imports from any country maintaining a substantially positive trade balance with the United States. A congressional proposal has called for a 25 percent surcharge when a country's exports exceeded their buying from the United States by 65 percent, with an exemption earned in a year in which trade surplus was reduced by 10 percent. Had such a proposal been in effect in 1985, it would have had an impact on Korea, Taiwan, Brazil, and Japan.<sup>18</sup>
6. Requiring that the U.S. Government turn over tariffs collected on textile and apparel imports to the industry for capital expenditure assistance.
7. Implementing an import licensing system for textiles and apparel. Such a system could work to prevent overshipments, since goods would need a quota allocation to be shipped; it could limit fraud and transshipment for the pur-

pose of quota evasion.<sup>20</sup>

8. Establishing a data bank on cost of manufacture of specific textile and apparel products by country, with details of the cost components. In this manner, import shipments data and anti-dumping and/or countervailing duty petitions could be monitored promptly where appropriate.
9. Reexamining those aspects of the Caribbean Basin Initiative which allow "maximum access" to goods sewn in Caribbean nations from U. S.-made fabric.

### **Other Trade Policy Areas**

Several general proposals, which relate to trade policy for textiles and apparel in so far as they relate to all industries, have been suggested:

- **Education: Government support** to improve the general level of "technological literacy" of the U.S. population is a high priority for public policy.
- **Tax Policy:** It has long been a recommendation of the AFL-CIO to "purge the tax code of incentives for the movement of U.S. jobs overseas through eliminating the foreign tax credits and the deferral of taxes on nonrepatriated foreign earnings."<sup>21</sup> Some believe that tax allowances for small operations could help them to increase their productivity. Others propose the use of targeted investment credits, aimed at adoption of state-of-the-art technology. Changes in tax laws on depreciation are also part of many proposals.
- **Tariff Policy: Several groups believe** that items 806.30 and 807 of the Tariff Schedules of the United States (TSUS) should be repealed.
- **Policy on Multinationals: Existing codes of conduct for multinational enterprises might be strengthened to protect the rights of workers employed by these firms, and to provide effective remedies when these rights are denied.**
- **U.S.-Supported Loan and Investment Programs for Overseas Businesses:** It has been argued that the Overseas Private Investment Corporation (OPIC) should be terminated. As

<sup>17</sup> "American Textile Manufacturers Institute, *Textile Trends*, vol XXXIV, No 45, No 14, 1986, p 1

<sup>18</sup> "The New Trade Strategy," *Business Week*, Oct 7, 1985, p. 93

<sup>19</sup> Senator Ernest Hollings, Statement on Thailand, Nov. 13, 1985, p. 2

<sup>20</sup> Testimony of Sol Chaikin, President, International Ladies' Garment Workers' Union, Subcommittee on International Trade, Committee on Finance, U.S. Senate, July 15, 1985, p. 3.

<sup>21</sup> AFL-CIO Executive Council on Trade, "Executive Council statement," Feb. 18, 1986, p. 2.

a government agency that insures private investment abroad, it is argued that OPIC has contributed to the export of U.S. jobs.

Another international program that may need reconsideration based on U.S. trade interests is loans from the International Monetary Fund (IMF), which often require that the borrowing countries curb imports and push exports in order to pay their debts. Instead, the IMF might be urged to promote balanced growth in both borrowing and in lending countries.

While Export Import (Exim) Bank funding—including direct loan authority, which provides U.S. industry with tools necessary for international competition—is likely to be maintained, the AFL-CIO has proposed that funds should not be used to develop projects in other countries in industrial sectors where a significant excess in U.S. capacity exists.<sup>22</sup>

<sup>22</sup>Ibid., p. 30.

## RESEARCH AND DEVELOPMENT (R&D)

Maintaining a technological edge over competitors has been a long standing strategy in the United States for maintaining a productivity edge and a comparative advantage. Some R&D for textiles and apparel is for new product development; other R&D is for process improvements. Much research within the industry complex could be systemwide, not just centered around automating a small part of the activity. Many current research efforts involve groups outside the traditional textile industry and its supporting research facilities, since the new generation of equipment—including computers, communication software, and sensors—requires contributions from industries that formerly did not participate in R&D for textiles and apparel. Because of this need for generic, system-level research, government help may be required in many areas of technological development.

### **Public/Private Ventures**

Coordinated R&D is a policy option receiving greater attention as a mechanism to increase the competitive strength of U.S. textile companies. This coordination could be done privately, through greater funding of research institutes by textile companies; presently, the Textile Research Institute in Princeton, New Jersey, serves such a function. Further movement in this direction may require review and/or amendment of some anti-trust restrictions.

Coordination could also be accomplished through public funding, or some combination of private and public funding. The Textile/Clothing Technology Corp. ((TC)<sup>2</sup>) is a modest effort at coordinated pub-

lic/private R&D efforts; representatives from industry, government, and academia are working together in the development of advanced automation of apparel production, (TC)<sup>2</sup> technology is currently being applied by the Singer Sewing CO. \*S Such efforts could be expanded.

One example of coordinated, government guided and funded R&D in the apparel field is in Japan; the goals for this R&D program were discussed in chapter 2. In 1982, the Japanese Government created the Automated Sewing System Technology Development Association, in response to complaints from Japanese apparel firms of a labor shortage in sewing. The purpose of such research is to cope with shorter production cycles and an increasing variety of consumer needs with a smaller labor force. The Japanese project is funded at \$60 million, and is due to be completed in 1989. The research segments have been undertaken by the 28 companies that comprise the association—firms that include major apparel manufacturers; fiber manufacturers; sewing manufacturers; and manufacturers of microelectronics, robots, and computers,

Another Japanese example of public/private cooperation in R&D is in microelectronics, a field crucial to the textile industry. From 1976 through 1979, the government spent 30 billion yen, or about \$125 million, on a 72 billion yen public/private budget. A joint laboratory was setup to develop a large-scale, integrated circuit technology. Added to the coordinated activities of the research scientists of these

<sup>23</sup>Frank Bray and Vince Vento, "Chapter Two Begins With Singer," *Bobbin Magazine*, September 1986, p. 170.

firms was the heavy involvement of management, including company presidents.<sup>24</sup>

Some experts recommend that the coordination of R&D be international in scope, arguing that the speed of technology transfer makes any technological breakthrough and its economic advantages to the developer short term at best. An example of such coordination can be found in a broad EEC program, "Basic Research in Industrial Technologies in Europe" (BRITE). Over 10 projects related the manufacture of textiles and apparel have been approved under BRITE's auspices, ranging from research of automated sewing and ironing techniques to the development of sophisticated management information networks. Each BRITE project involves at least two companies from at least two countries, and the EEC contributes half of BRITE's funding.<sup>25</sup>

Currently, most basic R&D is performed in universities, with the more applied research carried out by industry. Du Pont chairman Edward Jefferson looks toward an important government role in providing support for the basic research establishment in the universities, and in encouraging cooperation between industry and universities.<sup>26</sup>

One suggestion to promote R&D is to consider further revisions of U.S. anti-trust laws, which would allow competing firms to pool and coordinate R&D resources. While there has been some relaxation of anti-trust legislation, proponents of pooling resources suggest that the industry should consider supporting greater movement in this direction. This, they argue, would allow companies to more often and more effectively share the costs, risks, and benefits of major R&D projects. Such large-scale joint efforts exist in Japan, where major fiber manufacturers reached an agreement to develop an innovative, high-efficiency fiber production process. Aimed at quicker polymerization goals, the results of this effort include 50 percent reduction of energy consumption, 40 percent lower labor costs, and 10 percent lower total costs. The proposed 1983 budget was \$9.6

million, and the project is expected to be complete in 1988.<sup>27</sup>

### **Investment Incentives**

The high cost of new technology may make government investment incentives for the industry necessary—especially for the apparel sectors, which remain far behind their textile cousins in terms of innovation and productivity growth. In fact, (TC)<sup>2</sup> represents the first large-scale corporate effort to invest in apparel R&D. The industry may need stronger stimulus toward investment; tax policy could be a likely vehicle. According to Kurt Salmon Associates, "The government should give the industry money to help itself, not just burial insurance."<sup>28</sup> John Gregg, chairman of the Fiber, Fabric, and Apparel Coalition for Trade, and president of Avtex Fibers, Inc., has also voiced support for investment incentives.<sup>29</sup>

### **Other Strategies**

A public/private strategy to make R&D in textile manufacturing a dynamic force for industrial revitalization will not be easily formulated, especially in an industry where most important machinery development is done by firms which are not themselves manufacturers of textile products, but of textile machinery. Indeed, because most R&D is done by machinery manufacturers, textile and apparel firms have little control over the types of developments that occur. In addition, the majority of R&D done by machinery manufacturers is being done by foreign-owned firms.

More control over future innovations is believed to be important for the development of the U.S. industry. It is too simplistic, however, to assume that R&D could simply be relocated from the machinery manufacturers to the textile manufacturers. The expense of R&D alone makes it prohibitive to all but the largest firms.

One area of textile research that does not "belong" to the machinery manufacturers is fiber research—an area in which many of the goals are for the development of new products, or new applications for

<sup>24</sup>*Japan Economic Newspaper*, July 7, 1983, p. 1

<sup>25</sup>BRITE—The Community Programme of Research in Industrial Technologies—Gets Under Way, "Press Release, Commission of the European Communities, Brussels, Feb. 4, 1986.

<sup>26</sup>E.G. Jefferson, Chairman, E.I du Pont de Nemours & CO., 40th Anniversary of the Society of Fiber, Science, and Technology', Tokyo, May 11, 1984, p. 9.

<sup>27</sup>*Japan Times*, June 21, 1983, p. 12

<sup>28</sup>Bruce Stokes, "Getting Competitive," *National Journal*, June 7, 1986, p. 1365.

<sup>29</sup>*Ibid*



emerging products. Typically, these efforts are undertaken by large chemical corporations and universities. Coordinating trends in fiber R&D with policy to encourage innovation is important, especially to producers of textile products for industrial use. The related field of geotextiles, for example, is growing, and yet science and technology seem to lag behind the broad range of geotextiles applications—ranging from road construction, to beach erosion control, to highway drainage control, to railroad track stabilization.

Ludwig Rebenfeld of the Textile Research Institute has suggested that work on pore structure of textiles, and on such fiber properties as cross-sectional shape, is necessary if further control of fac-

tors like durability, dimensional stability, abrasion resistance, bursting strength, and permeability are to be achieved.<sup>30</sup> The use of fibers in composites and as polymeric reagents are also burgeoning fields, in which successful R&D could well promote the development of new products for sale. According to Rebenfeld, the research community for fiber needs to be integrated into the overall field of materials science; cross-fertilization among those developing new materials and material applications with those developing fibers could have important synergistic effects.<sup>31</sup>

---

<sup>30</sup>Ludwig Rebenfeld, "Textile Fibers—Past Trends and Future Opportunities," *International Dyeing Seminar*, Apr. 17, 1986.

<sup>31</sup>*Ibid.*

# **Glossary**

# Glossary

---

- Automation:** The use of advanced mechanical equipment, especially in combination with high-speed computers and other self-regulating controls. Automation includes almost every operation that dispenses with human assistance or control, whether because of newly developed control machinery or because of mechanical improvements on the assembly line.
- Backward Integration:** Where a firm extends itself into a previous stage of the production process.
- Cambric:** A very fine, thin linen.
- Carding:** The process in yarn manufacture in which the fibers are brushed up, made more or less parallel, have considerable portions of foreign matter removed, and are put into a manageable form known as sliver.
- Cellulose:** A substance which constitutes the chief part of the solid framework of plant life such as cotton. One of the greatest products made from cellulose base is the manmade fiber group of textile yarns—viscose rayon, cuprammonium, nitro-cellulose and acetate.
- Chute-fed Cards:** The pneumatic transport of cotton from cleaning through carding.
- Clothing, Card:** Rollers or flats that are clothed with fine, cylindrical pressed steel wire, and do carding.
- Carding:** Removal of all fibers below a certain staple length; i.e., shorter length fibers; and setting them in a uniform, parallel order ready for further manipulation.
- Concentration Ratio:** The percentage of total businesses in a given industry that is handled by a specified number of the largest firms—generally expressed as the percentage of business assets, production, sales, employment, or profits accounted for by the three to eight largest firms.
- Contractors:** Those who receive cut garment part bundles from jobbers and perform all necessary operations to assemble and process them into finished garments.
- Creel:** A device used as a spool rack for winding warp. Also used to hold warp ends for a sectional beam.
- Dobbyweave:** A weave with small, geometric patterns.
- Doffing:** Stripping the sliver from the carding machine.
- Drawing:** The process of combing individual ends of sliver (usually 6 to 8) and drafting them to a lower, specified weight per unit length (i.e., grains per yard).
- Durable Goods:** Pieces of equipment, for either consumers or producers, that in normal use are likely to last longer than three years.
- End:** A warp yarn or thread that runs lengthwise or vertically in cloth.
- Ends Down:** Warp ends which have broken in weaving, thereby impeding production.
- False Twist:** The major process used in texturizing filament yarns. A rotating spindle twists the yarn, then sets it in a heater-box or tube, and untwisting follows. The twist is not permanent but as a result the yarn becomes taut.
- Filament:** A fiber of indefinite length, such as filament acetate, rayon, nylon.
- Filling:** In woven fabric, the yarn that is inserted across the loom. Also referred to as weft, or crosswise yarns in the fabric.
- Finishing:** The art and science of making materials presentable to the consuming public. The final process such as bleaching, dyeing, pressing, printing, or waterproofing.
- Fly Shuttle:** Invented in 1938, the fly shuttle is thrown through the shed of the loom by pulling a cord.
- Forward Integration:** Where a firm moves into a succeeding stage of the production process or a succeeding stage of activity.
- Geotextiles:** Woven or nonwoven fibrous networks used in civil engineering applications. They are used principally for drainage control, where they serve as filters; for soil separations, where they serve as confinement media; and for foil reinforcement, where they serve to achieve optimal load distributions.
- Greige:** Unbleached and undyed cloth or yarn.
- Hard Automation: New** technological developments of custom-engineered automated manufacturing machinery, built to accomplish a specific set of tasks and incapable of doing other tasks without disassembly and rebuilding.
- Hopper:** a device into which material is deposited and from which it is automatically fed into a machine.
- Horizontal Integration:** The situation existing in a firm whose products or services are competitive with each other, the expansion of a firm into the production of new products that are competitive with older ones.
- Jacquard Loom:** A loom using a card punched with holes arranged to create an infinite variety of figured weaves.
- Jobbers:** Those with responsibility for their own designs, who acquire the necessary fabric and related materials and arrange for sale of the finished product. With the exception of cutting the fabric into the requisite garment sections, jobbers contract out the production operations. Many jobbers also contract out cutting and shipping functions.
- Lap: Loosely** compressed cotton sheets. The card changes a lap into a sliver.
- Licker-in:** A hollow grooved cylinder used in carding; it opens the tufts of cotton held by the feed roll and plate.

**Noncellulosic Fibers:** These are man-made, “synthetic” or manufactured textile fibers made from chemical polymers.

**Nonwoven Fabric:** A structure produced by bonding or the interlocking of fibers, or both, done by mechanical, chemical, thermal, or solvent means, and the combination thereof. The term does not include fabrics which are woven, knitted, tufted, or constructed by wool felting processes.

**Open-end Spinning:** A competitor of the ring spinning method, open-end spinning has a three to five times greater production rate. This is possible by isolating the twisting operations to a drum which rotates the open end of the yarn while additional fibers entering the drum are attracted to the yarn by rotational forces. The use of an air stream is the most common way for transporting fibers. In open-end spinning, twisting is not linked to the package and packages are not limited in size. Rewinding is often eliminated. Less power is needed to rotate the small end of the frame though the exact amount of reduction depends on the design of the frame and the speed at which it operates.

**Opener Picker:** An auxiliary cleaning machine used when high-quality cotton yarn is desired.

**Opening:** The initial treatment of raw cotton; the separation and opening up of the cotton to remove compression because of baling and shipping. Heavier impurities are also removed from the stock. Opening is concluded when the cotton lap is made ready for actual carding.

**Pick:** One passage or throw of the shuttle of a loom; one of the weft threads, or filling yarns; to throw (a shuttle).

**Picker Lap:** The lap or web obtained as the cotton comes from the finisher picker machine.

**Picking:** Continuation of the opening process which casts out the heavier wastes in cleaning the stock; the process in yarn manufacture of cleaning the fiber and forming it into a sheet which is compressed and wound on a cylindrical roll.

**Ply:** The number of individual yarns twisted together to make a composite yarn.

**Ply Weave:** Any cloth made from more than one set of warp and filling threads.

**Polymer:** A comparatively large molecule produced by linking together many molecules of a monomeric substance. Such a reaction is called polymerization.

**Racking:** Movement of the needle beds in a knitting machine in relation to each other.

**Reed:** One of a number of thin, flat pieces of pressed-steel wire between which the respective warp ends are drawn after they pass through the correct heddle eye on the proper harness frame in the loom.

**Ring Spinning:** In ring spinning, the package is rotated to insert the twist and to wind the new yarn onto the

bobbin. Package speed is limited by the mechanical considerations and development of high tensions. Yarn package is limited in size so as to be confined within a yarn balloon and requires a great amount of power both for its rotation and to insert the necessary twist.

**Robots:** Reprogrammable multi-functional manipulators designed to move material, parts, tools, or specialized devices through variable programmed motions for the performance of a variety of tasks.

**Robotics:** The study of robots, their design, manufacture, use, etc.

**Roving:** The last process before spinning in which the soft strand of sliver is drafted and twisted sufficiently to hold it together during spinning. Also referred to as the strand of fiber produced by the process.

**S.I.C. (Standard Industrial Classification)-Numerical classification of industries introduced in 1948 from where a larger number of digits indicates a more disaggregate classification. Establishments are allocated to digital categories according to their principle products.**

**Satin Weave:** Has no distinguishable twill line despite its actual presence in the cloth. Brought about by the way in which the interlacing of the threads is arranged. Gives a more solid and glossy appearance on the face of the goods than any other type of weave.

**Selvage (Selvedge):** A narrow woven edge portion of fabric parallel to the warp, made with special stronger yarns.

**Slashing:** The sizing of warp yarns to protect the yarns against injury during weaving.

**Sliver:** The loose, thin continuous rope-like soft strand of parallel fibers which is the product from carding, combing, and drawing, and which is ready for drawing.

**Spinning:** The final process in forming yarn in which the soft roving strand is drafted by a series of rollers and twisted to provide strength.

**Staple:** The average length of the bulk of fibers.

**Tappet:** A projection or lever that moves or is moved by intermittent contact, as with a cam, in an engine or machine.

**Texturizing:** When a smooth continuous manmade fiber filament is given a new and permanent configuration which results in an appealing textural surface.

**Twill Weave:** A weave which repeats on three threads each way. The number of possible twill formations is almost limitless.

**Twisting:** The act of turning a strand of parallel fibers on itself to provide the necessary strength to hold it together. Also the process of combining two or more strands of yarn into a single strand.

**Tieing-in Machine:** A machine that automatically ties the ends of yarn from the run-out warp to the ends of the new warp which will be placed in the loom after the old warp has been taken out.

**Upland Cotton:** The standard American cotton and the one by which all other cottons are compared for properties and characteristics. It ranges from 3/4 inch to 1 1/4 inch in staple length.

**Vertical Integration:** The operation of a single firm at more than one stage of production. The most comprehensive type of vertical integration would include productive stages from the processing of the raw material to the completion and distribution of the finished product.

**Warp:** The threads running lengthwise in the loom and crossed by the weft.

**Warping:** The process in which several hundred individual strands of yarn are formed into a parallel sheet and wound onto a special beam for slashing or dyeing.

**Weaving:** Interlacing two yarns so they cross each other at right angles to produce woven fabric.

**Weft:** (Sometimes called woof or filling.) The yarns carried by the shuttle back and forth across the warp in weaving.

**Winding:** A process of transferring yarn or thread from one type of package to another; e.g., from bobbins to tubes.