

THIS FILE IS MADE AVAILABLE THROUGH THE DECLASSIFICATION EFFORTS AND RESEARCH OF:

THE BLACK VAULT

THE BLACK VAULT IS THE LARGEST ONLINE FREEDOM OF INFORMATION ACT / GOVERNMENT RECORD CLEARING HOUSE IN THE WORLD. THE RESEARCH EFFORTS HERE ARE RESPONSIBLE FOR THE DECLASSIFICATION OF THOUSANDS OF DOCUMENTS THROUGHOUT THE U.S. GOVERNMENT, AND ALL CAN BE DOWNLOADED BY VISITING:

[HTTP://WWW.BLACKVAULT.COM](http://www.blackvault.com)

YOU ARE ENCOURAGED TO FORWARD THIS DOCUMENT TO YOUR FRIENDS, BUT PLEASE KEEP THIS IDENTIFYING IMAGE AT THE TOP OF THE .PDF SO OTHERS CAN DOWNLOAD MORE!



DEPARTMENT OF DEFENSE

Chemical and Biological Defense Program

Annual Report To Congress

March 2000

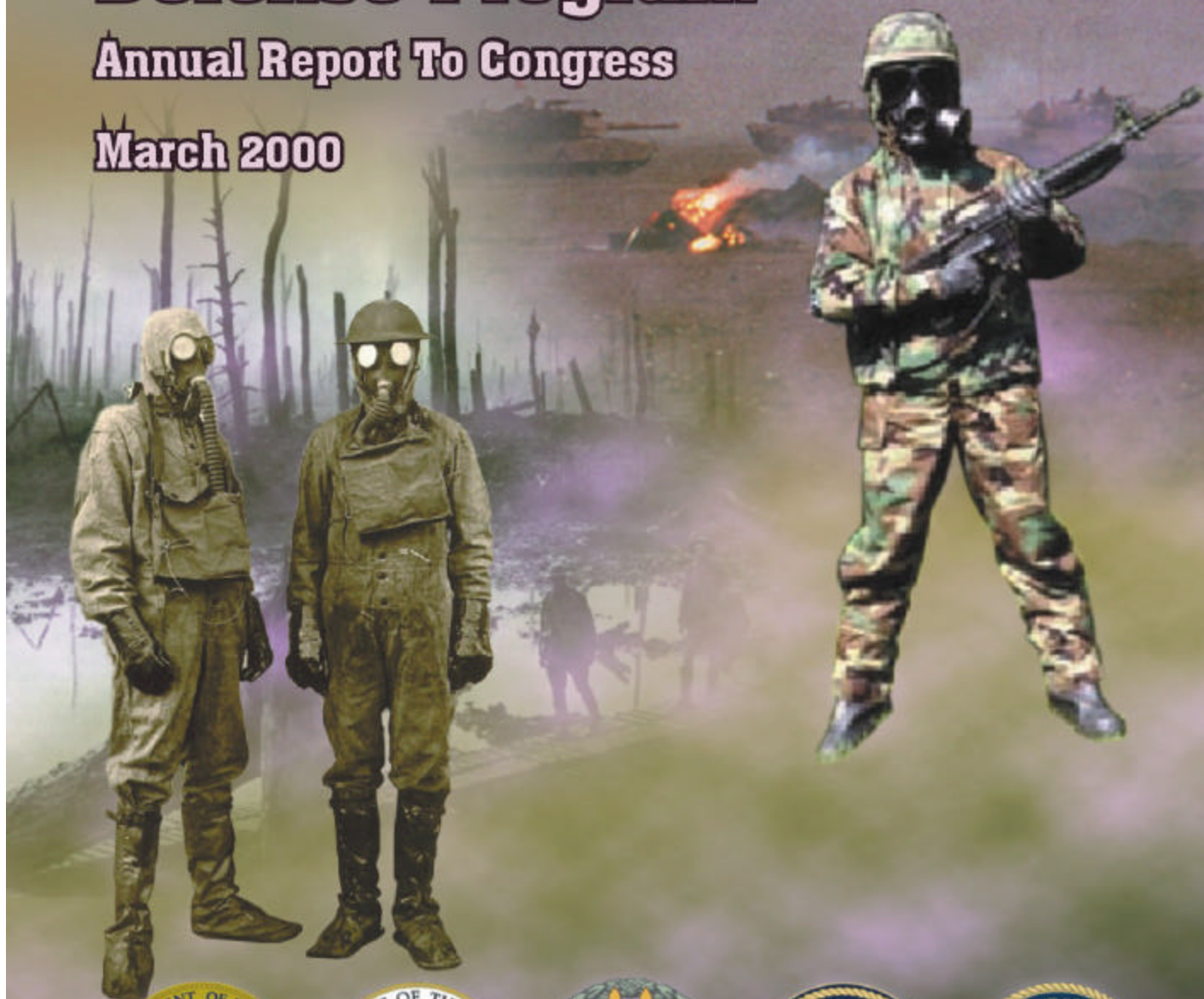

Chemical and Biological Protection over the Century

The cover design illustrates chemical protective ensembles at the beginning of the century (World War I era chemical protective ensembles, shown on the left) and at the end of the century (the currently fielded Joint Service Lightweight Integrated Suit Technology ensemble with the M40 Protective Mask, shown on the right). The basic concept has changed little over a century (that is, prevent contact with the toxic agents). However, there have been significant improvements in the materials providing protective masks and ensembles that are more effective in protecting the individual, more durable, and less cumbersome for the wearer.

To order additional copies of this report, contact:

Defense Technical Information Center
Attn: DTIC-E (Electronic Document Project Officer)
8725 John J. Kingman Road, Suite 0944
Fort Belvoir, VA 22060-6218

Visit the DTIC web site for further information at:
<http://www.dtic.mil>

This report may be downloaded in electronic format from the Department of Defense web site at <http://www.defenselink.mil>

Cleared for public release.
Unlimited distribution.

Use of Trade Names or Trademarks: The use of trade names or trademarks in this publications does not constitute endorsement by the Department of Defense.

Executive Summary

The National Defense Authorization Act for Fiscal Year 1994, Public Law No. 103-160, Section 1703 (50 USC 1522), mandates the coordination and integration of all Department of Defense chemical and biological (CB) defense programs. As part of this coordination and integration, the Secretary of Defense is directed to submit an assessment and a description of plans to improve readiness to survive, fight and win in a nuclear, biological and chemical (NBC) contaminated environment. This report contains modernization plan summaries that highlight the Department's approach to improve current NBC defense equipment and resolve current shortcomings in the program. *50 USC 1522 has provided the essential authority to ensure the elimination of unnecessarily redundant programs, focusing funds on DoD and program priorities, and enhancing readiness.*

The objective of the Department of Defense (DoD) Chemical and Biological Defense Program (CBDP) is to enable our forces to survive, fight, and win in a chemically or biologically contaminated warfare environment. The DoD CBDP provides development and procurement of systems to enhance the ability of U.S. forces to deter and defend against CB agents during regional contingencies. The probability of U.S. forces encountering CB agents during worldwide conflicts remains high. An effective defense reduces the probability of a CB attack, and if an attack occurs, it enables U.S. forces to survive, continue operations, and win. Scientific, technological, and resource limitations remain in preventing U.S. forces from having complete full dimensional protection and meeting all requirements for two nearly simultaneous Major Theater Wars. The unique physical, toxicological, destructive, and other properties of each threat requires that operational and technological responses be tailored to the threat. Nevertheless, significant progress has been made in overcoming these limitations since the establishment of the DoD CBDP. Still, U.S. forces remain the best protected forces in the world for surviving and conducting operations in chemically or biologically contaminated environments.

During the past year, DoD took several steps to ensure the protection of U.S. forces against both immediate and future chemical and biological threats. This report details DoD's current and planned capabilities. Highlights from the past year include continuing immunization of all U.S. forces with the licensed anthrax vaccine, and continued enhancement of DoD CBDP funds to protect against validated and emerging threats through the far-term future.

Numerous rapidly changing factors continually influence the program and its management. These factors include declining DoD resources, planning for warfighting support to numerous regional threat contingencies, the evolving geopolitical environment resulting from the breakup of the Soviet Union, the entry into force of the Chemical Weapons Convention, and continuing proliferation of NBC weapons. To minimize the impact of use of NBC weapons on our forces, the DoD CBDP will continue to work towards increasing the defensive capabilities of Joint Forces to survive and continue the mission during conflicts that involve the use of NBC weapons. NBC defense programs are managed jointly under the oversight of a single office within DoD.

The program continues to implement congressional direction to improve jointness and reflects an integrated DoD developed program. This year's program continues funding to support the highest priority counterproliferation initiatives. During the past year, the Department reviewed its capabilities to protect against the asymmetric threats from chemical and biological weapons. As a result of the review, funding was identified to enhance and accelerate high-payoff technologies and advanced CB defense systems. The FY0001 President's Budget Submission includes \$380 million in increased research and development funding for biological warfare defense and vaccines over the FY 2000-05 Future Years Defense Program (FYDP), as well as additional FY 1999 Emergency Supplemental funding to procure CB defense equipment for the Guard and Reserves to support the Consequence Management mission. Moreover, the Department continues to procure new CB defense equipment for our forces, due in large measure to the May 1997 *Report of the Quadrennial Defense Review* (QDR) recommendation to increase planned spending on counterproliferation by \$1 billion over the FY 1999-2003 program period, of which \$732 million was allocated for chemical and biological defense efforts.

The DoD CBDP invests in technologies to provide improved capabilities that have minimal adverse impact on our warfighting potential. Joint and Service unique programs provide capabilities to support the framework of the three commodity areas of CB defense: Contamination Avoidance (detection, identification, warning/reporting, reconnaissance), Protection (individual, collective, medical support), and Decontamination. All of these capabilities integrated together as a system-of-systems are essential to avoid contamination and to sustain operational tempo on an asymmetric battlefield. Moreover, sound Joint doctrine and realistic training remain fundamental to our defense against chemical and biological weapons. In summary, the DoD CBDP is focusing on a jointly integrated, balanced approach to obtaining needed capabilities for our forces within affordability constraints.

OVERVIEW OF REPORT

The **INTRODUCTION** provides a background of the rationale and purpose of the DoD Chemical and Biological Defense Program (CBDP). This section summarizes the key counter-proliferation priorities and the current chemical and biological warfare threats to U.S. forces. Intelligence documents tailored to the threat are essential for developing and updating requirements for chemical and biological defense programs. Each chemical and biological defense research, development, and acquisition effort funded within the program responds to a defined or validated threat. Variations among chemical and biological agents and each agent's unique physical, toxicological, destructive, and other properties such as means of delivery require that operational and technological responses be tailored to the threat. Intelligence efforts continue to emphasize collection and analysis of nations' dual-use chemical and biological industrial capabilities and develop the indications and warning of adversarial use of dual-use capabilities.

CHAPTER 1 describes the accomplishments, processes, and issues related to DoD CBDP management and oversight. Since the program's inception, DoD has made significant progress in improving the overall joint management and coordination of the NBC defense program, including integration of medical and non-medical chemical and biological defense programs. *50 USC 1522 has been a critical tool for ensuring the elimination of redundant programs, focusing funds on program priorities, and enhancing readiness.* This chapter outlines the changes within the oversight and management structure that have occurred as a result of the Defense Reform Initiative and the establishment of the Defense Threat Reduction Agency.

CHAPTER 2 provides information on non-medical NBC defense requirements and research and development programs. Requirements and the status of research and development assessments are described within the framework of the functional areas of NBC defense.

CHAPTER 3 provides information on medical NBC defense requirements and on research and development programs. Medical technologies are an integral part of providing individual protection both prior to, during and after a chemical or biological attack.

CHAPTER 4 provides an analysis of NBC defense logistics posture. The analysis reviews the status of quantities, characteristics, and capabilities and limitations of all fielded NBC defense equipment, industrial base requirements, procurement schedules, and problems encountered. Much of the information is based on the model of Joint Chemical Defense Equipment Consumption Rates (JCHEMRATES IV). Additional information is derived from the Joint NBC Defense Logistics Support Plan.

CHAPTER 5 assesses the status of NBC defense training and readiness conducted by the Services. Each of the Services' training standards and programs is reviewed. In accordance with Section 1702 of P.L. 103-160 (50 USC 1522) all chemical and biological warfare defense training activities of the Department of Defense have been consolidated at the United States Army Chemical School. This chapter also provides information on the move of the Chemical School from Fort McClellan, Alabama to Fort Leonard Wood, Missouri.

CHAPTER 6 provides information on the status of DoD efforts to implement the Chemical Weapons Convention (CWC), which was ratified by the United States and entered into force during 1997. This chapter also includes a summary of plans and activities to provide assistance to other countries in response to an appeal by another State Party to the CWC, pursuant to Article X of the CWC.

Finally, there are several **ANNEXES** to this report. **Annexes A through D** provide detailed information on Joint and Service-unique NBC defense equipment, including contamination avoidance, protection, decontamination, and medical programs. Detailed descriptions are provided for systems and equipment that have been fielded, are in production, or under development. **Annex E** provides a summary of funds appropriated, budgeted, and expended by the DoD CDBP. One of the successes of the DoD NBC Defense Program has been the consolidation of all DoD NBC Defense RDT&E and procurement program funds under defense-wide program elements, rather than throughout numerous Service accounts. **Annex F** provides a reference to NBC defense related sites on the internet. **Annex G** provides a statement regarding chemical and biological defense programs involving human subjects as required by 50 USC 1523. As detailed in the annex, no such testing has been conducted in over two decades and none is planned. **Annex H** provides the text of the congressional language requiring this report. **Annex I** provides a list of the many acronyms and abbreviations that are used throughout this report.

Table of Contents

	Page	
EXECUTIVE SUMMARY	<i>i</i>	
INTRODUCTION	1	
I Purpose of Report	1	
II Government Performance and Results Act.....	1	
III The Current Chemical and Biological Warfare Threat	6	
 CHAPTERS		
1 DOD CHEMICAL AND BIOLOGICAL DEFENSE PROGRAM		
MANAGEMENT AND OVERSIGHT		13
1.1 Introduction	13	
1.2 Management Implementation Efforts	13	
1.3 Organizational Relationships.....	13	
1.4 Coordination with Related Programs and Initiatives.....	16	
1.4.1 Other U.S. Government Agencies	16	
1.4.1.1 DARPA Biological Warfare Defense Program	16	
1.4.1.2 Technical Support Working Group (TSWG).....	17	
1.4.1.3 DoE Chemical and Biological Nonproliferation Program	18	
1.4.2 International Cooperation	18	
1.5 Technology Base Review and Assessment	19	
1.6 Funds Management	19	
1.7 CB Defense Program Management Assessment	21	
2 NON-MEDICAL NBC WARFARE DEFENSE REQUIREMENTS		
AND R&D PROGRAM STATUS		23
2.1 Introduction	23	
2.2 NBC Defense Mission Area Requirements and RDA Summary.....	26	
2.3 Contamination Avoidance (Detection, Identification and Warning)	26	
2.3.1 Contamination Avoidance Science and Technology Efforts	27	
2.3.1.1 Goals and Timeframes	27	
2.3.1.2 Potential Payoffs and Transition Opportunities.....	28	
2.3.1.3 Major Technical Challenges	28	
2.3.2 Contamination Avoidance Modernization Strategy.....	29	
2.3.3 Joint Service Contamination Avoidance Programs.....	31	
2.3.4 Warning and Reporting	33	
2.3.5 Other Contamination Avoidance Programs.....	34	
2.3.6 Defense Advanced Research Projects Agency (DARPA) Programs	35	
2.4 Protection	36	
2.4.1 Protection Science and Technology Efforts	36	
2.4.1.1 Individual Protection Goals and Timeframes	36	
2.4.1.2 Collective Protection Goals and Timeframes	36	
2.4.1.3 Potential Payoffs and Transition Opportunities.....	37	
2.4.1.4 Major Technical Challenges	37	

2.4.2	Protection Modernization Strategy.....	38
2.4.3	Joint Service Protection Programs	41
2.4.4	DARPA Protection Programs	44
2.4.5	Other Protection Programs	44
2.5	Decontamination	45
2.5.1	Decontamination Science and Technology Efforts.....	45
2.5.1.1	Goals and Timeframes	45
2.5.1.2	Potential Payoffs and Transition Opportunities.....	46
2.5.1.3	Major Technical Challenges	46
2.5.2	Decontamination Modernization Strategy	46
2.5.3	Joint Service Decontamination Programs	47
2.5.4	Other Decontamination Programs	48
2.6	Non-Medical CB Defense Requirements Assessment.....	49
3	MEDICAL NBC WARFARE DEFENSE REQUIREMENTS AND R&D PROGRAM STATUS.....	51
3.1	Requirements	51
3.1.1	Introduction	51
3.1.2	Challenges in the Medical NBC Warfare Defense Programs.....	52
3.1.3	Medical CB Defense Requirements.....	54
3.1.4	Reducing Reliance on Research Animals.....	55
3.1.5	Medical Program Organization	55
3.2	Joint Medical Chemical Defense Research Program.....	56
3.2.1	Goals.....	56
3.2.2	Objectives.....	57
3.2.3	Threats, Countermeasures, Technical Barriers, Status, and Accomplishments	58
3.3	Joint Medical Biological Defense Research Program.....	59
3.3.1	Goals.....	59
3.3.2	Objectives.....	59
3.3.3	Threats, Countermeasures, and Technical Barriers	62
3.3.4	DARPA Programs	63
3.4	Medical Nuclear (Radiological) Defense Research Program.....	64
3.4.1	Goals.....	64
3.4.2	Objectives.....	65
3.4.3	Threats, Countermeasures, Technical Barriers, and Accomplishments	65
3.5	Medical NBC Research Projection.....	67
3.6	Medical Requirements Assessment	68
4	NBC DEFENSE LOGISTICS STATUS	71
4.1	Introduction	71
4.2	NBC Defense Logistics Management	73
4.3	Quantities, Characteristics, and Capabilities	75
4.4	Logistics Status.....	76
4.5	Peacetime Requirement	80
4.6	Funding.....	81

4.7	Industrial Base	82
4.8	NBC Defense Logistics Support Assessment	83
	Appendix 1: Breakout of Service War Requirements, Stocks On-Hand, and Planned Acquisitions	86
	Appendix 2: Fielded NBC Defense Items – Issues and Concerns	101
	1. Contamination Avoidance	101
	2. Individual Protection	102
	3. Collective Protection	105
	4. Decontamination	106
	5. Medical	107
5	NBC DEFENSE READINESS AND TRAINING	111
5.1	Introduction	111
5.2	Joint NBC Defense Doctrine	111
5.2.1	Joint NBC Defense Doctrine Program Management	112
5.2.2	Joint NBC Defense Doctrine Development Program	112
5.2.3	Army Medical Doctrine Development Program	113
5.2.4	Air Force Doctrine Program	113
5.2.5	Navy Doctrine	114
5.2.6	Marine Corps Doctrine	114
5.3	Standards of Proficiency and Currency	114
5.3.1	Army	114
5.3.2	Air Force	120
5.3.3	Navy	122
5.3.4	Marine Corps	123
5.4	NBC Defense Professional Training	125
5.4.1	Joint NBC Defense Professional Training	125
5.4.2	Army NBC Defense Professional Training	126
5.4.3	Air Force NBC Defense Professional Training	128
5.4.4	Navy CBR Defense Professional Training	129
5.4.5	Marine Corps NBC Defense Professional Training	130
5.5	Training in a Toxic Chemical Environment	132
5.6	Integration of Realism/Wargames/Exercises	133
5.6.1	Simulations and Wargames	133
5.6.2	Joint NBC Training/Joint and Combined Exercises	135
5.7	Initiatives	138
5.7.1	Joint	138
5.7.2	Army	139
5.7.3	Air Force	140
5.7.4	Navy	141
5.7.5	Marine Corps	141
5.7.6	Emergency Response: Army Medical Response	142
5.7.7	Medical Countermeasures and Surveillance against NBC and other Battlefield Toxicants and Occupational Health Hazards	146
5.7.8	Air Force Modular NBC Teams	148
5.8	Readiness Reporting System	149

5.9	NBC Defense Training and Readiness Assessment.....	150
6	STATUS OF DOD EFFORTS TO IMPLEMENT THE CHEMICAL WEAPONS CONVENTION.....	151
6.1	Introduction	151
6.2	Department of Defense Implementation of the CWC	151
6.3	Safety Orientation for Inspectors	152
6.4	Preparation of Defense Installations.....	152
6.5	Defense Treaty Inspection Readiness Program.....	153
6.6	Article X Assistance and Other Assistance.....	153
6.7	Verification Technology	153

ANNEXES	Page
A Contamination Avoidance Programs	A-1
1. Fielded and Production Items	A-1
2. RDTE Items.....	A-11
B Non-Medical Protection Programs	B-1
1. Fielded and Production Items	B-1
2. RDTE Items.....	B-14
C Decontamination Programs	C-1
1. Fielded and Production Items	C-1
2. RDTE Items.....	C-4
D Joint Medical Chemical, Biological, and Nuclear Defense Research Programs	D-1
D.1 Medical Chemical Defense Research Program	D-1
D.2 Medical Biological Defense Research Program.....	D-10
D.3 Medical Nuclear (Radiological) Defense Research Program.....	D-28
E Joint Nuclear, Biological, and Chemical, Defense Program Funding Summary	E-1
F Nuclear, Biological, and Chemical Defense Internet Sites	F-1
G Statement Regarding Chemical and Biological Defense Programs Involving Human Subjects.....	G-1
H Congressional Reporting Requirement: 50 USC 1523	H-1
I Acronyms and Abbreviations.....	I-1

TABLES AND FIGURES

TABLES	Page
I-1 Required CINC Counterproliferation Capabilities.....	5
2-1 Prioritized Joint Future Operational Capabilities.....	24
2-2 Prioritized Non-Medical NBC Defense Programs.....	25
2-3 Contamination Avoidance Science and Technology Strategy.....	28
2-4 Contamination Avoidance Modernization Strategy.....	29
2-5 Contamination Avoidance RDA Efforts.....	30
2-6 Protection Science and Technology Strategy.....	37
2-7 Protection Modernization Strategy.....	39
2-8 Protection RDA Efforts.....	40
2-9 Decontamination Science and Technology Strategy.....	46
2-10 Decontamination Modernization Strategy.....	47
2-11 Decontamination RDA Efforts.....	48
3-1 CB Defense Prioritized Medical Requirements.....	54
3-2 Medical Chemical Defense Countermeasures and Diagnostic Techniques.....	58
3-3 Anthrax Vaccine Immunization Program (AVIP).....	60
3-5 Medical Biological Defense Countermeasures and Diagnostic Techniques.....	63
3-6 Medical Nuclear Defense Countermeasures.....	66
3-3 Medical NBC Defense Programs and Modernization Strategy.....	67
4-1 Logistic Risk Assessments: 50 NBC Defense Items.....	79
4-2a Army Logistics Readiness Data - Nonconsumables.....	87
4-2b Army Logistics Readiness Data - Consumables.....	88
4-3a Air Force Logistics Readiness Data - Nonconsumables.....	90
4-3b Air Force Logistics Readiness Data - Consumables.....	91
4-4a Navy Logistics Readiness Data - Nonconsumables.....	93
4-4b Navy Logistics Readiness Data - Consumables.....	94
4-5a Marine Corps Logistics Readiness Data - Nonconsumables.....	96
4-5b Marine Corps Logistics Readiness Data - Consumables.....	97
4-6 Defense Logistics Agency Logistics Readiness Data - Consumables.....	99
5-1 NBC-R Capability In Current Constructive Simulations.....	134

FIGURES	
1-1 Chemical and Biological Defense Management and Oversight.....	15
1-2 Chemical and Biological Defense Funds Management Process.....	20
3-1 Integration of FDA and DoD Milestone Requirements.....	53
4-1 War Reserve Requirements and Planning.....	74
4-2 Logistic Risk Assessments: 50 NBC Defense Items.....	77
5-1 USMC Individual NBC Training.....	124
5-2 USMC Collective Training, NBC Requirements.....	125
5-3 U.S. Army Entry Training.....	127
5-4 U.S. Army Officer Advanced Training.....	128
5-5 USMC Individual Training (Enlisted NBC Specialists).....	131
5-6 USMC Individual Training (Training for NBC Officers).....	132
5-7 Chemical/Biological Incident Response Force (CBIRF) Role in Training.....	141

Introduction

I. PURPOSE OF REPORT

In accordance with 50 USC 1523, this report provides Congress with an assessment of the overall readiness of the Armed Forces to fight in a chemical and biological warfare environment. This is the seventh report submitted under 50 USC 1523.*

II. GOVERNMENT PERFORMANCE AND RESULTS ACT (GPRA)

The following information outlines the vision, mission, values, and objectives of the DoD Chemical and Biological Defense Program in compliance with the GPRA.

Department of Defense Vision, Goals, and Objectives

The United States embraces several fundamental and enduring objectives: to maintain the sovereignty, political freedom, and independence of the United States with its values, institutions, and territory intact; to protect the lives and personal safety of Americans, both at home and abroad; and to provide for the well-being and prosperity of the nation and its people.

Achieving these basic objectives in an increasingly interdependent world requires fostering an international environment in which the spread of nuclear, biological, chemical, and other potentially destabilizing technologies is minimized. Key objectives that guide U.S. defense policy and planning include *shaping* the international environment through military engagement programs and activities, and *responding* to the full spectrum of crises with appropriately sized, positioned, and mobile forces. Of equal importance, the United States must prepare for an uncertain future by pursuing a focused modernization effort that maintains U.S. superiority in key warfighting capabilities.

It is the vision of the Department of Defense to:

- Field the best trained, best equipped, best prepared fighting force in the world.
- Support alliance and security relationships that protect and advance U.S. security interests.
- Advance national interests by working effectively with other federal agencies, Congress, and the private sector.
- Serve as a model of effective, efficient, innovative management and leadership.

* The text of 50 USC 1523, *Annual report on chemical and biological warfare defense*, (implemented as part of Public Law 103-160, the FY94 National Defense Authorization Act) is included at Annex H.

In support of this vision, the Department has established two corporate-level goals:

- Goal 1.** Shape the international environment and respond to the full spectrum of crises by providing appropriately sized, positioned, and mobile forces.
- Goal 2.** Prepare now for an uncertain future by pursuing a focused modernization effort that maintains U.S. qualitative superiority in key warfighting capabilities. Transform the force by exploiting the Revolution in Military Affairs, and reengineer the Department to achieve a 21st century infrastructure.

Chemical and Biological Defense Program Vision, Mission, Values, and Goals

The vision, mission, values, and goals of the DoD Chemical and Biological Defense Program (CBDP) support the Department of Defense vision and goals. The CBDP was established to coordinate and integrate the research, development, and acquisition (RDA) of chemical and biological defense materiel and systems to support the joint warfighting forces. The CBDP provides materiel and systems to support the activities of training, doctrine, and military operations. However, these activities are the responsibility of the Military Departments and the Commanders-in-Chief. The vision, mission, values, and goals of the CBDP are focused on RDA activities.

The DoD cannot strengthen its capabilities to survive, fight, and win in a CB contaminated environment simply by spending more money. DoD must use the limited resources to focus assets of the development and acquisition of materiel and systems to support the needs and prioritized requirements of the joint warfighting forces, and to defend against validated and credible threats to U.S. forces and assets.

Following is an overview of the direction of the CBDP. These ideas will be formalized in a performance plan that will be developed over the next year. This plan will provide guidance for the key planning documents of the CBDP, including the Modernization Plan, the Research, Development, and Acquisition Plan, the Logistics Support Plan, and other planning documents. These plans will incorporate specific program goals and performance measures, which will support the CBDP vision and increase the capabilities of the joint warfighting forces — not merely outline a spending plan.

CBDP Vision

Provide a jointly coordinated and integrated program within the Department of Defense for the research, development, and acquisition of capabilities to protect the joint warfighting forces and resources from the threat or use of chemical or biological warfare agents so that our personnel are the best equipped and best prepared fighting force in the world.

CBDP Mission

Provide chemical and biological defense capabilities to allow the military forces of the United States to survive and successfully complete their operational missions—from peacetime missions through two nearly simultaneous major theater wars—in battlespace environments contaminated with chemical or biological warfare agents.

CBDP Values

- **Deter the use of chemical and biological warfare agents.**
 - Deny the advantage of the potential effective use of any chemical or biological warfare agents through a system of capabilities to avoid, protect against, and sustain operations in a chemically or biologically contaminated environment — with only minimal performance degradation from either the effects of the agents or any protective equipment or medical countermeasures.
- **Ensure all capabilities provided respond to threats.**
 - Provide capabilities that address the highest priority chemical and biological agent threats, from immediate and validated threats through potential far term or emerging threats. Intelligence efforts must emphasize preparation of tailored intelligence documents that identify and assess threats from the the full spectrum of potential chemical and biological warfare agents, and include collection and analysis of nations’ “dual-use” chemical and biological industrial capabilities and the indications and warning of adversarial use of dual-use capabilities. Tailored intelligence documents are essential for developing and updating requirements for CB defense programs.
- **Emphasize a Joint Service approach to chemical and biological defense research, development, and acquisition.**
 - Eliminate unnecessary redundancies among the Services and Defense Agencies, leverage common technologies and requirements, and provide capabilities for Service-unique missions. Ensure coordination among U.S. government agencies and among U.S. allies to field the best available chemical and biological defense capabilities.
- **Develop and acquire capabilities that are based on identified and prioritized requirements and mission needs.**
 - Ensure that acquisition planning is driven by operational requirements rather than by available funds or technology. However, cost, schedule, and performance should be optimized in all programs planning.
- **Maintain technological advantage over any potential adversaries and prevent technological surprise.**
 - Evaluate and leverage continuous improvements in the state-of-the-art in sciences and technology base.
- **Provide for a modernization strategy that minimizes CB casualties and provide capabilities to treat casualties and maximize return to duty.**

Chemical/Biological Defense Program Corporate-Level Goals

In order to pursue the mission of the CBDP, the following major goals have been established. Goals for specific technologies and systems will be developed during FY2000 and included in the CBDP Performance Plan. Following are key goals of the CBDP. (*Selected supporting capabilities are shown following each goal.*)

- View NBC warfare agents within the Theater Area of Operations –
(*Early Warning and Stand-off Detection of NBC Agents*)
- Dominate the Battlespace through Reconnaissance, Surveillance, and Target Acquisition (RSTA) –
(*NBC Reconnaissance Systems*)
- Enhance the situational awareness of Unit Battlespace –
(*Automatic Point Detection of NBC Agents, and Modeling and Simulation*)
- Provide real-time hazard information to influence current operations –
(*NBC Battle Management and Warning & Reporting*)
- Enhance personnel and equipment survivability –
(*Individual Detection, Individual and Collective Protection, Medical defenses, Decontamination, and NBC contamination survivability*)
- Maintain ground, air and maritime Operational Tempo –
(*Operational Decontamination and Collective Protection*)
- Sustain operations, recovery and reconstitution efforts –
(*Training, Readiness, and Restoration Operations*)

All of the capabilities integrated together as a system-of-systems are essential to avoid contamination and to sustain operational tempo on an asymmetric battlefield. Sound Joint doctrine and realistic training remain fundamental to defense against NBC weapons.

The President's December 1999 report, *A National Security for a New Century*, emphasizes the three key elements of the executive branch's strategy as (1) to enhance our security with effective diplomacy and with military forces that are ready to fight and win; (2) to bolster America's economic prosperity; (3) to promote democracy abroad. U.S. forces must have numerous capabilities in order to respond and deploy quickly to various worldwide needs. Counterproliferation capabilities are required by forces to meet worldwide needs, and NBC defense is integral to counterproliferation capabilities. The Commanders-in-Chief have identified their priorities for counterproliferation capabilities. These priorities are shown in Table I-1. Capabilities which are supported by the NBC defense program are highlighted in **bold**. As currently identified, NBC defense capabilities are listed in four of the top five CINC priorities. *Individual protection* includes physical protection devices, medical immunization and prophylaxis, and NBC casualty medical treatment. *Collective protection* provides relief from sustained operations in full individual NBC protective equipment, shelters for sensitive equipment not easily decontaminated, and clean environments for operations that cannot be performed under NBC contaminated conditions. *Mitigating the effects of WMD use* includes capabilities for integrated NBC warning and reporting; thorough and rapid mobile intratheater decontamination; medical countermeasures (vaccines, antibiotics, antidotes, and pre-treatments); mobile and portable

detection and characterization devices (including stand-off); and mass casualty NBC treatment. *Detecting WMD* includes capabilities to locate and characterize the use of WMD.

Table I-1. Required CINC Counterproliferation Capabilities

1.	Provide individual protection to forces and assist allies/coalition partners with relief from the effects of NBC
2.	Intercept conventional delivery of WMD and control collateral effects
3.	Provide collective protection to forces and assist allies/coalition partners with relief from the effects of NBC
4.	Mitigate the effects of WMD
5.	Detect and monitor development, production, deployment, employment of WMD
6.	Communicate the ability/will to employ interdiction/response capabilities
7.	Determine vulnerabilities in WMD development, production, transfer, deployment, and employment
8.	Conduct off-site attack to destroy, disable, and deny WMD targets
9.	Establish and maintain relations with allies, and potential adversaries to discourage development, production, and use of WMD
10.	Seize, destroy, disable, and deny transport of WMD
11.	Communicate the ability/will to employ defensive capabilities
12.	Determine vulnerabilities in decision making process related to WMD
13.	Conduct information warfare to destroy, disable, and deny WMD
14.	Support treaties, export controls, and political/diplomatic efforts
15.	Provide alternatives to the pursuit of WMD
16.	Provide intelligence collection capabilities in support of USG non-proliferation efforts
17.	Conduct on-site attack to seize, destroy, disable, and deny WMD targets
18.	Provide personnel, training, materiel, and equipment to support security assistance
19.	Destroy, disable, and deny actor's non-WMD resources and capabilities

The response to the threat of NBC weapons must be based on the nature of this threat, not just where the threat occurs. A key part of DoD's strategy is to stem the proliferation of such weapons and to develop an effective capability to deal with these threats. To focus the response to the threat, DoD and the intelligence community have completed several classified reports providing threat assessments on chemical and biological threats to U.S. forces. To minimize the effect of these threats to U.S. forces, DoD continues to improve defensive capabilities. These continuing improvements also contribute to our overall deterrence by demonstrating to an adversary that use of NBC agents or weapons provides little or no military advantage. The DoD CB Defense Program continues to work towards increasing the capabilities of Joint Forces to survive and continue their mission during conflicts that may involve the use of NBC agents or weapons.

The number of nations with chemical and biological weapons (CBW) capabilities is not changing greatly, despite the implementation of the Chemical Weapons Convention. In addition, those countries with chemical weapons programs are adding agents and more sophisticated delivery systems. Similarly, the sophistication of CBW capabilities is increasing. Proliferation of weapons technology, precision navigation technology, nuclear (medical, power, and industrial applications), and CBW technology to developing nations presents the United States with a complicated national security challenge. Intelligence efforts include collection and analysis of nations' "dual-use" nuclear, chemical and biological industrial capabilities, and development of the indications and warning of adversarial use of dual-use capabilities. Tailored intelligence

documents are essential for developing and updating requirements for CB defense programs. Numerous threat documents tailored to the CB threat have been produced and are updated periodically. The Intelligence Community continues to review U.S. chemical and biological warfare intelligence requirements and assess the adequacy of intelligence assets to execute the required intelligence program.

III. THE CURRENT CHEMICAL AND BIOLOGICAL WARFARE THREAT

Northeast Asia

North Korea has been pursuing research and development related to biological warfare since the 1960s. Pyongyang's resources presently include a rudimentary (by Western standards) biotechnology infrastructure that is sufficient to support the production of limited quantities of toxins, as well as viral and bacterial biological warfare agents. In the early 1990s, an open press release by a foreign government referred to applied military biotechnology work at numerous North Korean medical institutes and universities dealing with pathogens such as anthrax, cholera, and plague. North Korea possesses a sufficient munitions-production infrastructure to accomplish weaponization of BW agents. North Korea acceded to the Biological Weapons Convention (BWC) in 1987.

By comparison, North Korea's chemical warfare program is believed to be mature and includes the capability, since 1989, to indigenously produce bulk quantities of nerve, blister, choking and blood chemical agents as well as a variety of different filled munitions systems. North Korea is believed to possess a sizable stockpile of chemical weapons, which could be employed in offensive military operations against the South. North Korea has also devoted considerable scarce resources to defensive measures aimed at protecting its civilian population and military forces from the effects of chemical weapons. Such measures include extensive training in the use of protective masks, suits, detectors, and decontamination systems. Though these measures are ostensibly focused on a perceived threat from U.S. and South Korean forces, they could also support the offensive use of chemical weapons by the North during combat. North Korea has yet to sign the Chemical Weapons Convention (CWC) and is not expected to do so in the near-term, due to intrusive inspection and verification requirements mandated by the agreement.

China possesses an advanced biotechnology infrastructure as well as the requisite munitions production capabilities necessary to develop, produce and weaponize biological agents. Although China has consistently claimed that it has never researched or produced biological weapons, it is nonetheless believed likely that it retains a biological warfare capability begun before acceding to the BWC.

China is believed to have an advanced chemical warfare program that includes research and development, production and weaponization capabilities. Its current inventory is believed to include the full range of traditional chemical agents. It also has a wide variety of delivery systems for chemical agents to include artillery rockets, aerial bombs, sprayers, and short-range ballistic missiles. Chinese forces, like those of North Korea, have conducted defensive CW

training and are prepared to operate in a contaminated environment. As China's program is further integrated into overall military operations, its doctrine, which is believed to be based in part on Soviet-era thinking, may reflect the incorporation of more advanced munitions for CW agent delivery. China has signed and ratified the CWC.

South Asia

India has a well-developed biotechnology infrastructure that includes numerous pharmaceutical production facilities bio-containment laboratories (including BL-3) for working with lethal pathogens. It also has qualified scientists with expertise in infectious diseases. Some of India's facilities are being used to support research and development for BW defense purposes. These facilities constitute a substantial capability for offensive purposes as well. India is a signatory to the BWC of 1972.

India also has an advanced commercial chemical industry, and produces the bulk of its own chemicals for domestic consumption. New Delhi ratified the CWC in 1996. In its required declarations, it acknowledged the existence of a chemical warfare program. New Delhi has pledged that all facilities related to its CW program would be open for inspection.

Pakistan has a capable but less well-developed biotechnology infrastructure than India. Its facilities, while fewer in number, could nonetheless support work on lethal biological pathogens. Moreover, Pakistan is believed to have the resources and capabilities necessary to support a limited offensive biological warfare research and development effort. Like India, Pakistan is a signatory to the BWC.

Pakistan has a less-well developed commercial chemical industry but is expected to eventually have the capability to produce all precursor chemicals needed to support a chemical weapons stockpile. Like India, Pakistan has numerous munitions systems which could be used to deliver CW agent, including artillery, aerial bombs, and missiles. Pakistan has ratified the CWC, but submitted a null declaration.

The Middle East and North Africa

Iran's biological warfare program, which began during the Iran-Iraq war, is now believed to generally be in the advanced research and development phase. Iran has qualified, highly trained scientists and considerable expertise with pharmaceuticals. It also possesses the commercial and military infrastructure needed to produce basic biological warfare agents and may have produced pilot quantities of usable agent. Iran is a signatory to the BWC of 1972.

Iran initiated a chemical weapons program in the early stages of the Iran-Iraq war after it was attacked with chemical weapons. The program has received heightened attention since the early 1990s with an expansion in both the chemical production infrastructure as well as its munitions arsenal. Iran currently possesses munitions containing blister, blood, and choking agents and may have nerve agents as well. It has the capability to deliver CW agents using artillery shells and aerial bombs. Iran has ratified the CWC, declared agents and chemical agent

production facilities, and is obligated to open suspected sites to international inspection and eliminate its CW program.

Prior to the Gulf War, *Iraq* developed the largest and most advanced biological warfare program in the Middle East. Though a variety of agents were studied, Iraq declared anthrax, botulinum toxin, and aflatoxin to have completed the weaponization cycle. During the Gulf War, coalition bombing destroyed or damaged many key facilities associated with BW activity. However, it is suspected that a key portion of Iraq's BW capability, in the form of agent-filled munitions, was hidden and may have subsequently escaped damage. Nonetheless, Iraq declared, after the war, that all BW agent stockpile and munitions were unilaterally destroyed. United Nations Special Commission (UNSCOM) activity has, however, revealed this assertion as well as many others related to BW activity, to be inaccurate and misleading. As with its chemical program, Iraq intends to re-establish its BW capabilities if afforded the opportunity by the relaxation or cessation of UNSCOM inspection activity.

Iraq had a mature chemical weapons program prior to the Gulf War that included a variety of nerve agents, such as tabun (GA), sarin (GB), and GF, as well as the blister agent mustard, available for offensive use. Iraq also undertook a program, begun in 1985 and continuing uninterrupted until December 1990, to produce the advanced nerve agent VX. Recent UNSCOM findings indicate that Iraq had weaponized VX in Al Hussein missile warheads. Although Iraq's chemical warfare program suffered extensive damage during the Gulf War and subsequently from UNSCOM activity, Iraq retains a limited capability to re-constitute key parts of its chemical warfare program. Moreover, UNSCOM, despite having destroyed over 700 metric tons of agent, is still unable to verify elements of Iraqi declarations such as the disposal of chemical precursors, as well as the destruction of all chemical munitions. The comprehensive nature of Iraq's previous chemical warfare activity and the consistent pattern of denial and deception employed by Iraqi authorities indicate a high-level intent to rebuild this capacity, should Iraq be given the opportunity.

Syria has a limited biotechnology infrastructure but could support a limited biological warfare effort. Though Syria is believed to be pursuing the development of biological weapons, it is not believed to have progressed much beyond the research and development phase and may have produced only pilot quantities of usable agent. Syria has signed, but not ratified, the BWC.

Syria has a mature chemical weapons program, begun in the 1970s, incorporating nerve agents, such as sarin, which have completed the weaponization cycle. Future activity will likely focus on CW infrastructure enhancements for agent production and storage, as well as possible research and development of advanced nerve agents. Munitions available for CW agent delivery likely include aerial bombs as well as SCUD missile warheads. Syria has not signed the CWC and is unlikely to do so in the near future.

Libya's biological warfare program is believed to remain in the early research and development phase. Progress has been slow due in part to an inadequate scientific and technical base. Though Libya may be able to produce small quantities of usable agent, it is unlikely to

transition from laboratory work to production of militarily significant quantities until well after the year 2000. Libya acceded to the BWC in 1982.

Libya has experienced major setbacks to its chemical warfare program, first as a result of intense public scrutiny focused on its Rabta facility in the late 1980s and more recently on its Tarhuna underground facility. Nevertheless, Libya retains a small inventory of chemical weapons, as well as a CW agent production capability. Prior to closing its Rabta plant in 1990, Libya succeeded in producing up to 100 tons of blister and nerve agent at the site. Although the site was re-opened in 1995, ostensibly as a pharmaceutical plant, the facility is still believed capable of producing CW agents. CW-related activities at the Tarhuna site are believed to be suspended. Libya has not ratified the CWC and is not likely to do so in the near future.

Independent States of the Former Soviet Union

The former Soviet offensive biological warfare program was the world's largest and consisted of both military facilities and nonmilitary research and development institutes. Non-military activity was centrally coordinated and performed largely through a consortium of institutes known as Biopreparat. This network of facilities was created in 1973 as a cover for activity related to biological warfare. This huge organization at one time employed up to 25,000 people and involved nearly 20 research, development and production facilities. The Russian government has committed to ending the former Soviet BW program, although serious questions about offensive BW capabilities remain. Key components of the former program remain largely intact and may support a possible future mobilization capability for the production of biological warfare agents and delivery systems. Moreover, work outside the scope of legitimate biological defense activity may be occurring at selected facilities within Russia. Such activity, if offensive in nature, would contradict statements by top Russian political leaders that offensive activity has ceased.

While former Soviet biological warfare facilities existed in Ukraine, Kazakhstan, and Uzbekistan, none are currently active. Moreover, the governments in these new republics are not believed to have plans to establish any future BW capability. Also, Belarus has no program and no intention of establishing one. Ukraine, Belarus, and Uzbekistan have ratified the BWC, while Kazakhstan has not yet signed it.

Russia has acknowledged the world's largest stockpile of chemical agents, amounting to approximately 40,000 metric tons. This stockpile, consisting mostly of weaponized agent includes artillery, aerial bombs, rockets, and missile warheads. Actual agents include a variety of nerve and blister agents. Additionally, some Russian chemical weapons incorporate agent mixtures, while others have added thickening materials in order to increase agent persistence. Russian officials do not deny that CW research has continued but claim that it is for defensive purposes and therefore not proscribed by the CWC. Many of the components for new binary agents developed under the former-Soviet program have legitimate civilian applications and are not considered on the CWC's schedule of chemicals.

PROLIFERATION

The United States faces a number of regional proliferation challenges. Many of these are detailed in the November 1997 report published by the Office of the Secretary of Defense, *Proliferation: Threat and Response*. In the Middle East, Iran continues with a concerted effort to acquire an independent production capability for all aspects of its chemical weapons program and has reduced dependency on foreign assistance. China remains a key supplier of technologies and equipment for several Middle Eastern chemical warfare programs and may play a pivotal role in determining whether these countries attain their goals of independent production for these weapons. Iran is pursuing a program to purchase dual-use biotech equipment from other countries, ostensibly for civilian uses. Russia is a key source of biotechnology for Iran. Russia is an especially attractive target for Iranians seeking technical information on BW agent production processes.

Proliferation of chemical and biological warfare technology in South Asia also raises several important issues. India has exported a wide array of chemical products, including Australia Group-controlled items, to numerous countries of proliferation concern in the Middle East. The controlled items include specific chemical agent precursors, pathogens with biological warfare applications, and dual-use equipment which can be used in both chemical and biological warfare programs. Pakistan, on the other hand, may be seeking to upgrade key parts of its biotechnology infrastructure with dual-use equipment and expertise. Such acquisition efforts would reflect Pakistan's less-well developed biotechnology infrastructure.

In North Africa, Libyan efforts to acquire foreign equipment and expertise related to biological warfare have been dealt a severe blow, largely because of UN sanctions. Due to the international community's encompassing restrictions on exports to Libya, efforts to proceed beyond laboratory-scale research and development related to biological warfare will be difficult.

Australia Group

The proliferation of chemical and biological warfare related technology remains a critical threat to peace and stability throughout the world. One mechanism through which industrialized countries have agreed to control the proliferation of key chemical and biological warfare-related technologies is the Australia Group. The Australia Group (AG) is a consortium of countries organized to slow the proliferation of chemical and biological warfare programs through the imposition of multilateral export controls. Initial efforts of this group began in June 1985 and focused on precursor chemicals used in the manufacture of chemical agents. However, convinced of the threat posed from biological weapons, AG countries subsequently agreed, in December 1992, to also control the sale of items that most likely could be used to develop biological agents and weaponry. The AG adopted a list of human pathogens consisting of 37 organisms, 10 toxins and associated genetically modified organisms, and a seven-item BW dual-use equipment list. In addition, the AG later adopted animal and plant pathogen lists in recognition of the threat posed from anti-crop and anti-animal biological warfare.

OUTLOOK

In the next 10 years, the threat from the proliferation of CBW weapons will certainly increase. This will result from the development of chemical and biological agents that are more difficult to detect and from the adoption of more capable delivery systems.* DoD expects that more states with existing programs will master the production processes for complete weapons and will be less dependent on outside suppliers. States will be more proficient at incorporating chemical or biological agents into delivery systems and will be focusing on battlefield training as well as employment strategy and doctrine. Therefore, the threshold of some states to consider using these capabilities may be lowered.

DoD does not expect significant increases in the number of government-sponsored offensive CBW programs. Nevertheless, the United States and its allies must be alert to this possibility as well as to the apparent growing interest in CBW on the part of sub-national groups such as terrorist organizations. Any nation with the political will and a minimal industrial base could produce CBW agents suitable for use in warfare. Efficient weaponization of these agents, however, does require design and production skills usually found in countries that possess a munitions development infrastructure or access to such skills from cooperative sources. On the other hand, crude agent dispersal devices could be fabricated by almost any nation or group. Such weapons might be capable of inflicting only limited numbers of casualties; nevertheless, they could have significant operational repercussions due to the psychological impact created by fears of CBW agent exposure.

* An assessment of potentially new biological agents that may challenge U.S. forces is in a DoD report to Congress entitled *Advances in Biotechnology and Genetic Engineering: Implications for the Development of New Biological Warfare Agents*, June 1996.

(INTENTIONALLY BLANK.)

Chapter 1

DoD Chemical and Biological Defense Program Management and Oversight

1.1 INTRODUCTION

In compliance with public law, chemical and biological defense programs within the Department are overseen by a single office within the Office of the Secretary of Defense. The vision and mission of the Department's Chemical and Biological Defense Program are outlined in the introduction of this report. A key value in support of the program vision is to emphasize a Joint Service approach to chemical and biological defense research, development, and acquisition. This value provides a process that eliminates unnecessary redundancies among the Services, leverages common technologies and requirements, provides capabilities for Service-unique missions, and coordinates among U.S. government agencies and U.S. allies to field the best available chemical and biological defense capabilities. This chapter provides an overview of the processes involved in the oversight, management, and execution of the Chemical and Biological Defense Program.

1.2 MANAGEMENT IMPLEMENTATION EFFORTS

The Department of Defense (DoD) implemented a process to consolidate, coordinate, and integrate the chemical and biological (CB) defense requirements of all Services into a single DoD CB defense program. Additionally, DoD continues to refine organizations and processes to ensure close and continuous coordination between the Chemical Biological Warfare Defense program and the Medical Chemical Biological Defense program.

Through the Joint Service Agreement on NBC Defense, the Military Services have established a viable structure that ensures that Service operational needs are fully integrated and coordinated from their inception and that duplication of effort is eliminated from NBC defense research, development, and acquisition. The series of reviews conducted by the Joint Service Integration Group and the Joint Service Materiel Group, both separately and together, have proved to be an appropriate organizational method to accomplish the coordinating and integrating function. Section 1.3 details organizational relationships within the DoD CBDP. Section 1.4 highlights organizational relationships between the CBDP and related organizations within the Department of Defense, with other U.S. Government organizations, and international efforts with U.S. allies.

1.3 ORGANIZATIONAL RELATIONSHIPS

The CB Defense Program management structure, portrayed in Figure 1-1 represents the structure of the program coordination and integration. This management and oversight structure

was developed in late 1996 to provide integration of medical and non-medical CB defense efforts at the Service level. Integration of CB defense efforts continued in 1999.

The Deputy Assistant to the Secretary of Defense for Chemical and Biological Defense, DATSD(CBD), as a deputy to the Director, Defense Research & Engineering (DDR&E), is responsible for the overall coordination and integration of all CB defense research, development, and acquisition (RDA) efforts. DATSD(CBD) provides the overall guidance for planning, programming, budgeting, and executing the CB defense program.

DATSD(CBD) remains the single office within OSD responsible for oversight of the DoD CB Defense Program. DATSD(CBD) retains approval authority for all planning, programming, and budgeting documents. DATSD(CBD) is responsible for ensuring coordination between the medical programs and the non-medical CB defense efforts, and management oversight of the DoD CBDP in accordance with 50 USC 1522.

The DATSD(CBD) is also the Executive Secretary of the OSD NBC Defense Steering Committee (see Figure 1-1.) The OSD NBC Defense Steering Committee provides direct oversight of the DoD Chemical and Biological Defense Program. The OSD NBC Defense Steering Committee is composed of the following members: (1) DDR&E, (2) Director, Defense Threat Reduction Agency (DTRA), (3) Director, Chemical Biological Defense Directorate, DTRA, (DTRA(CB)), and (4) DATSD(CBD). The OSD NBC Defense Steering Committee is overseen by the Under Secretary of Defense for Acquisition, Technology, and Logistics, USD(AT&L), who currently serves as the Acting ATSD(NCB). The Steering Committee provides the fiscal and programming guidance to the Joint NBC Defense Board (JNBCDB) to develop the POM. The JNBCDB issues POM Preparation Instructions to the subordinate groups, which review the validated requirements and build the POM strategy recommendations.

The CBDP is divided into six commodity areas, with each commodity area being managed by one of the Services in accordance with the Joint Service Agreement, as follows:

<u>Commodity Area</u>	<u>Commodity Area Manager</u>
Contamination avoidance	Army
Individual protection	Marines Corps
Collective protection	Navy
Decontamination	Air Force
Medical defense	Army
Modeling & simulation	Navy

The commodity areas correspond to the projects under the budget program elements. There is also a program budget element to support program management and oversight, user testing (*i.e.*, Dugway Proving Grounds), and doctrine development in accordance with the Joint Service Agreement. The JSIG is the principal steering group that oversees the coordination and integration of Service and CINC requirements and priorities for RDT&E and initial procurement. The JSMG is the principal steering group that manages the execution of RDT&E materiel

development efforts to ensure that program risk is mitigated across commodity areas, and the ongoing efforts are complementary but not duplicative.

The Secretary of the Army is the Executive Agent for the CBDP and is responsible to coordinate, integrate, and review all Services' CB defense requirements and programs. The Secretary has delegated this responsibility to the Assistant Secretary of the Army for Acquisition, Logistics, and Technology, ASA(ALT), who along with the Vice Chief of Staff of the Army, co-chairs the Joint NBC Defense Board. The military departments' acquisition organizations execute the individual CB defense programs according to Service and DoD directives.

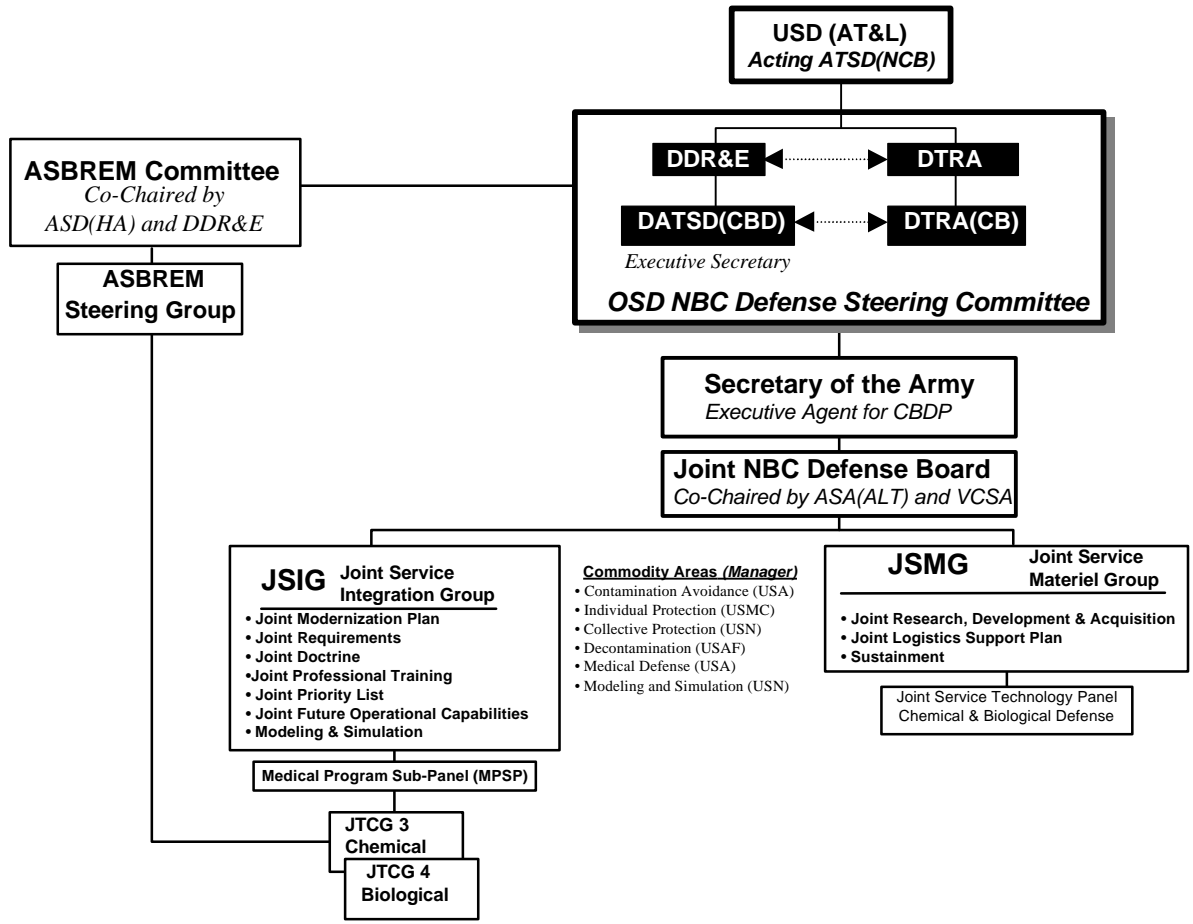

- | | |
|--|---|
| <p>ASA(ALT) - Assistant Secretary of the Army for Acquisition, Logistics, and Technology</p> <p>ASBREM - Armed Service Biomedical Research Evaluation and Management</p> <p>ASD(HA) - Assistant Secretary of Defense for Health Affairs</p> <p>ATSD(NCB) - Assistant to the Secretary of Defense for Nuclear and Chemical and Biological Defense Programs</p> <p>DATSD(CBD) - Deputy Assistant to the Secretary of Defense for Chemical and Biological Defense</p> <p>DDR&E - Director, Defense Research and Engineering</p> <p>DTRA - Director, Defense Threat Reduction Agency</p> | <p>DTRA(CB) - Director, DTRA Chemical and Biological Defense Directorate</p> <p>JTCG - Joint Technology Coordinating Group</p> <p>USA - United States Army</p> <p>USAF - United States Air Force</p> <p>USD(AT&L) - Under Secretary of Defense for Acquisition, Technology & Logistics; serves as the chairman of the Defense Acquisition Board</p> <p>USMC - United States Marines Corps</p> <p>USN - United States Navy</p> <p>VCSA - Vice Chief of Staff of the Army</p> |
|--|---|

Figure 1-1 CBDP Management & Oversight

A Medical Program Sub-Panel (MPSP) has been implemented as part of the JSIG. The purpose of the MPSP is to identify medical program needs and requirements as developed by the CINCs, Services, Joint Staff, the ASBREM Committee, and other users. The Armed Service

Biomedical Research Evaluation and Management (ASBREM) Committee is co-chaired by the Assistant Secretary of Defense for Health Affairs (ASD(HA)) and the Director Defense Research and Engineering (DDR&E) and includes the Joint Technology Coordination Group (JTTCG) 3 (Medical Chemical Defense Research Program) and JTTCG 4 (Medical Biological Defense Research Program). The MPSP has the primary responsibility for prioritizing medical NBC defense requirements. The users JTTCG 3 (Medical Chemical Defense Research Program), JTTCG 4 (Medical Biological Defense Research Program) and JTTCG 7 (Nuclear) provide input of medical requirements (separate from non-medical requirements) to the MPSP. The MPSP coordinates, integrates, and prioritizes all of the user requirements input. It provides the consolidated, integrated, and prioritized list of medical NBC defense requirements to the JSIG. The first priority listing was submitted 14 May 1999 to the JSIG. The JSIG then submits both the medical and non-medical requirements to the JNBCDB. The JSIG provides comments but makes no changes to the list when submitting the medical requirements to the JNBCDB. The JNBCDB and the OSD NBC Defense Steering Committee may make changes to the medical or the non-medical requirements and priorities lists.

1.4 COORDINATION WITH RELATED PROGRAMS AND INITIATIVES

The DoD Chemical and Biological Defense Program coordinates efforts with other U.S. government agency and with other countries to achieve the vision of equipping U.S. forces with the best available chemical and biological defense equipment. This section provides an overview of some key cooperative efforts.

1.4.1 Other U.S. Government Agencies

There are several organizations within the U.S. government developing chemical and biological defense technologies. Three organizations with which the CBDP currently has formal coordination efforts include: (1) the Defense Advanced Research Projects Agency (DARPA), (2) the Technical Support Working Group (TSWG), (3) the Department of Energy (DOE) Chemical and Biological Nonproliferation Program (CBNP). An overview of these programs is provided below. There also are other governmental agencies with chemical and biological defense related programs with which the CBDP maintains various levels of coordination and cooperation. These include the U.S. Department of Agriculture, the Center for Disease Control and Prevention, and the Department of Justice, among others.

1.4.1.1 DARPA Biological Warfare Defense Program. The Defense Advanced Research Projects Agency (DARPA) is charged with seeking breakthrough concepts and technologies that will impact our national security. DARPA's Biological Warfare (BW) Defense Program is intended to complement the DoD CB Defense Program by anticipating threats and developing novel defenses against them. The DARPA program is unique in that its focus is on the development of technologies with *broad applicability* against *classes* of threats. DARPA invests primarily in the early technology development phases of programs, with rapidly decreasing involvement in the succeeding stages that lead to system development and deployment.

The FY98 National Defense Authorization Act directed the Secretary of Defense to ensure that the DARPA biological warfare defense program is coordinated and integrated under the program management and oversight of the DoD CBDP. The DARPA BW Defense Program coordinates its efforts with a large number of organizations, including the DATSD(CBD) through regular briefings to both DATSD(CBD) and DTRA(CB) and by participation in the Technology Area Review and Assessment (TARA) process. The Advanced Diagnostics portion of the DARPA BW Defense Program is closely coordinated with the U.S. Army Medical Research and Materiel Command (MRMC) and maintains representation on the recently formed Common Medical Diagnostic Systems Executive Committee. A panel of chemical and biological defense experts is routinely consulted by DARPA to evaluate programs and to ensure that National Institutes of Health (NIH) efforts are not being duplicated. DARPA representatives actively serve on the Joint Service Technology Panel for Chemical and Biological Defense (JSTPCBD) and attend CBDP committee meetings, such as ASBREM sub-committee meetings. DARPA also participates in the BW Seniors Group, which provides Government coordination outside of DoD and works closely with the military Services to ensure that technologies are effectively transitioned into the hands of the user community.

1.4.1.2 Technical Support Working Group (TSWG). The mission of the TSWG is to conduct the national interagency research and development program for combating terrorism through rapid research, development and prototyping. TSWG objectives are: (1) to provide an interagency forum to coordinate R&D requirements for combating terrorism, (2) to sponsor research and development not addressed by individual agencies, and (3) to promote information transfer. The Department of State oversees the TSWG, and the Assistant Secretary of Defense for Special Operations and Low Intensity Conflict, ASD(SO/LIC), provides executive program direction. The Department of Defense provides program management for the TSWG. However, the TSWG coordinates with nearly all executive branch agencies, with state and local agencies, and with U.S. allies.

In support of its combating terrorism mission, the TSWG has established eight sub-groups, each of which is chaired (or co-chaired) by different federal agencies. One of the sub-groups — Chemical, Biological, Radiological, Nuclear Countermeasures (CBRNC) — is co-chaired by the Federal Bureau of Investigation (FBI) and the Central Intelligence Agency (CIA). The CBRNC sub-group is chartered to (1) identify and prioritize interagency requirements related to chemical, biological, radiological, and nuclear terrorism, and (2) identify and recommend potential solutions to meet user requirements in detection, protection, decontamination, containment, mitigation, and disposal.

The DoD CBDP and TSWG coordinate requirements to maximize technology development cooperation, thus avoiding unnecessary redundancy. The scope and mission of the TSWG, however, often requires different technologies to satisfy user requirements. The TSWG CBRNC sub-group is funded annually at approximately one percent of the level of total CBDP funding.

1.4.1.3 DOE Chemical and Biological Nonproliferation Program (CBNP). The CBNP was established in 1997 in response to the *Defense Against Weapons of Mass Destruction Act* (“Nunn-Lugar-Domenici”) passed by Congress in 1996. The CBNP was established to ensure the full engagement of the DOE National Laboratories in responding to the threat posed by chemical and biological weapons to U.S. civilians. The strategy of the CBNP relies on close linkages between technology development and systems analysis and integration to systematically and comprehensively address the domestic chemical and biological terrorism threat. The CBNP is comprised of three key components:

- Definition of operational needs to guide the development and implementation of enhanced preparedness and response systems.
- Use of accelerated system demonstrations to enable rapid fielding of the best available systems and technologies to meet critical needs.
- Development of individual technologies to enhance capabilities across the full spectrum of chemical and biological threats.

Many technologies under development may support both CBNP and CBBDP missions. There are formal agreements between the CBNP and CBBDP to ensure that efforts are coordinated and duplication is avoided. Some cooperative efforts include DOE representation on the Joint NBC Defense Board as a non-voting member, DOE participation in the Technology Area Review and Assessment (TARA) of science and technology base programs, and DoD participation in the annual CBNP program review.

1.4.2 International Cooperation

The CBBDP participates in numerous international cooperative and collaborative efforts to leverage technology development and to achieve commonality, interoperability, and systems integration among U.S. allies and coalition partners. (In addition, there are numerous cooperative efforts in doctrine and training, which are described in Section 5.2 of this report.) In order to exchange information or conduct government to government cooperation, an appropriate agreement must be in place. Types of agreements include (1) Data Exchange Agreements (DEAs), (2) Foreign Military Sales, (3) Engineer and Scientist Exchange Programs, (4) Foreign Comparative Testing, (5) Technology Development Project Agreements, and (6) long-term Memoranda of Understanding (MOU).

During FY99, the United States participated in numerous international cooperative research and development efforts. Highlights of these efforts include (1) 50 DEAs with 15 countries, (2) two Technology Development Project Agreements, (3) one MOU, and (4) over 100 scientists and engineers participating in exchange programs. In addition, there are three Technology Development Project Agreements currently in discussion phase and an additional MOU in negotiation.

All cooperative agreements yield benefits to all participants in the agreement. Some key systems within the CBBDP were procured through Foreign Military Sales, including the Improved Chemical Agent Monitor (ICAM), the NBC Reconnaissance System (Fox Vehicle), components

of the Biological Integrated Detection Systems, and the Automatic Chemical Agent Detector and Alarm (ACADA). In addition, there have been numerous CB defense capability gains during FY98 and FY99 as a result of international cooperation. Examples include:

- Ability to Detect and Identify Bacterial Spores
- Enhancement of Downwind Hazard Model
- First Generation Urban Dispersion Model
- Laser Standoff Chemical Detection Technology
- Next Generation Medical Countermeasures
- Encapsulated Antibiotics
- Multivalent Botulinum Toxin Vaccine
- Improved Plague Vaccine
- Report on Coalition CB Detection Capability to CENTCOM
- Current Detector/Monitor Technology
- CS Riot Control Capability on Light Vehicles
- Urban Field Trial
- Test and Procurement of Child/Infant CB System (USFK)
- Generic Individual Protection in Hot/Dry Environments
- Standardized Test for Individual Protection
- Standards for Measuring Biological Backgrounds
- Joint Medical Procedures in a BW Contaminated Environment

1.5 TECHNOLOGY BASE REVIEW AND ASSESSMENT

The DATSD(CBD) is the DDR&E office responsible for chemical and biological defense programs science and technology base programs. DATSD(CBD) provides technical oversight of all Service and Defense Agency chemical and biological defense science and technology base (S&T) programs and reviews these programs. The Joint Service Technology Panel for Chemical and Biological Defense (JSTPCBD), chaired by DTRA(CB), coordinates all Service science and technology base activities for the JSMG. DTRA(CB) prepares the relevant chemical and biological defense portions of two key documents detailing DoD S&T efforts — the Joint Warfighting S&T Plan (JWSTP) and the Defense Technology Area Plan (DTAP). These reports are submitted to Congress separately in accordance with public law.

1.6 FUNDS MANAGEMENT

Figure 1-2 describes the funds management and execution process for the CB defense program and the coordination between funding and executing organizations. The key organizations in this process are: DATSD(CBD) as the OSD focal point; the JNBCDB Secretariat representing the Executive Agent; the funds manager is the Defense Threat Reduction Agency (DTRA); the JSMG as coordinator and interface between the participating organizations; and the operating agencies and performers which execute the programs. For budget distribution, the JNBCDB Secretariat provides funds distribution information to DATSD(CBD) based on the appropriated budget. The DATSD(CBD) prepares funds suballocation instructions (with

support provided by DTRA(CB)) and submits them to the DTRA Comptroller for distribution to the operating agencies.

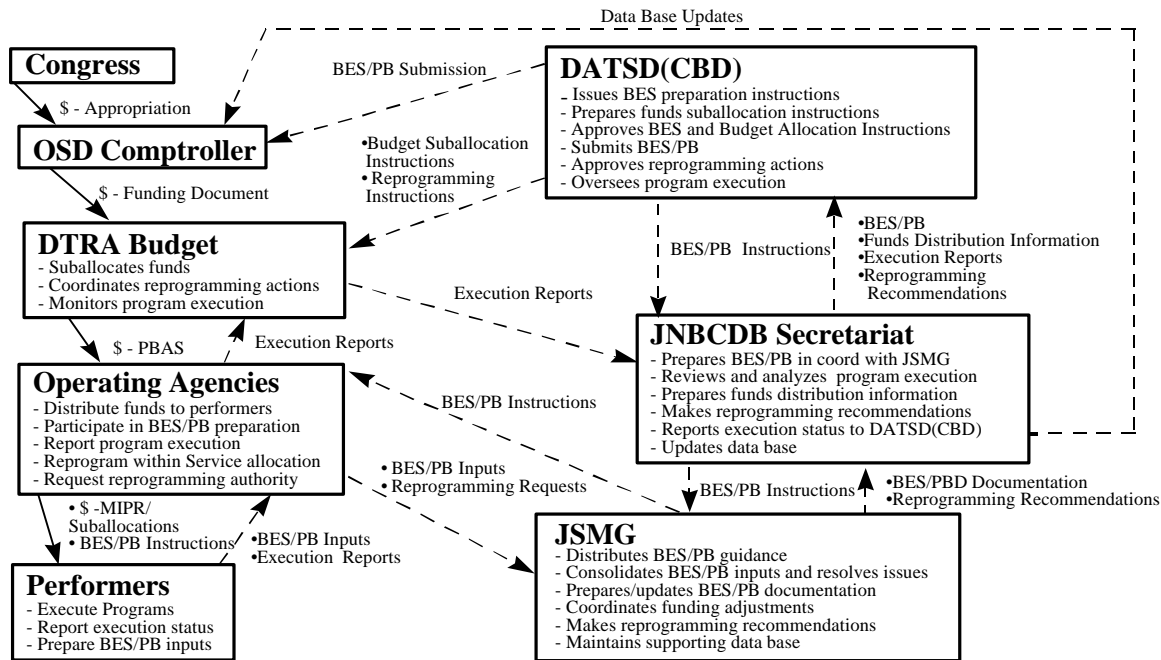

Figure 1-2. Chemical and Biological Defense Funds Management Process

The lead components or operating agencies provide notification of all funding adjustments to the JSMG Executive Office. The JSMG Executive Office, in turn notifies other components and agencies and the JNBCDB Secretariat. The JSMG Executive Office forwards to the JNBCDB Secretariat the reprogramming requests with recommendations and any concerns raised by the other components and operating agencies. The JNBCDB Secretariat reviews the reprogramming actions and forwards recommendations to DTRA(CB) for DATSD(CBD) approval. Once approved, DATSD(CBD) authorizes the JNBCDB Secretariat to update the database, and the DTRA Comptroller to execute the reprogramming. For medical programs, the Headquarters, U.S. Army Medical Research and Materiel Command staffs all actions resulting from the requirement to reallocate funds between the Services.

DATSD(CBD), with the support of DTRA(CB), instructs the DTRA Comptroller to issue execution and program status reporting instructions to the operating agencies. The operating agencies report execution status to the DTRA Comptroller on a monthly basis. The DTRA Comptroller forwards all program funds execution reports to the JNBCDB Secretariat and DTRA(CB) for program and budget database update and analysis, respectively. DTRA(CB) reports execution status to DATSD(CBD) on a quarterly basis. DTRA(CB) is responsible to notify the DATSD(CBD) when programs deviate from or are in danger of not meeting OSD obligation and execution goals.

The DTRA Comptroller serves as the funds manager for the CB defense program. This office issues funding documents, per DATSD(CBD) direction, and performs all required accounting functions, with the assistance of the Army staff which represents the Executive

Agent. The JNBCDB Secretariat updates the OSD comptroller program and budget databases as necessary after the POM, Budget Estimate Submission (BES), and President's Budget (PB). DATSD(CBD), with support provided by DTRA(CB), ensures that the JNBCDB Secretariat is kept informed of all OSD comptroller guidance, directives, and schedules.

1.7 CB DEFENSE PROGRAM MANAGEMENT ASSESSMENT

ISSUE: Oversight and management of the DoD CB Defense Program continues to mature. It is imperative that the management system produces joint CB defense requirements and NBC defense equipment that can be used by all forces. Public Law 103-160 (50 USC 1522) has provided a key tool for ensuring a jointly focused CB Defense Program. The continued support of Congress and implementation of current plans will continue to improve jointness and readiness.

SOLUTION: DoD has completed implementation of 50 USC 1522:

- DoD has developed an organizational structure ensuring close and continuous coordination of CB warfare defense and CB medical defense programs.
- The DoD CB Defense Program is fully integrated and coordinated and is based on validated Service requirements generated in response to defined threats. In addition, the Services now jointly prepare (i) Modernization Plans, (ii) Research, Development and Acquisition (RDA) Plans, and (iii) Joint Logistics Support Plans for NBC defense programs.
- Responsibility for the CB Defense Program is vested in a single office in OSD, DATSD(CBD), which provides the overall guidance for planning, programming, budgeting, and executing the CB Defense Program.
- The overall integrity of the CB Defense Program's organizational structure has been maintained throughout implementation of the Defense Reform Initiative (DRI) and establishment of the Defense Threat Reduction Agency through establishment of the OSD NBC Defense Steering Committee.

ISSUE: In its August 1999 report (NSIAD 99-159, 16 Aug 99), the General Accounting Office (GAO) recommended that a performance plan for the CB Defense Program should be developed and based on the outcome-oriented management principles embodied in the Government Performance and Results Act (GPRA).

SOLUTION: The introduction of this report outlines the broad mission, vision, values, and goals of the DoD CBDP. These statements provide linkage with the overall mission and vision of the Department of Defense and provide the framework for the development of a performance plan consistent with GPRA principles. To complete the performance plan, the CBDP is in the process of developing performance goals and performance measures. These goals and measures will be stated along with the development of the CBDP Program Strategy Guidance and incorporated into key planning, programming, and budgeting documents. A Performance Plan will be completed during calendar year 2000 and included in the next annual report to Congress.

(INTENTIONALLY BLANK.)

Chapter 2

Non-Medical Nuclear, Biological, and Chemical (NBC) Defense Requirements and Research, and Acquisition Program Status

2.1 INTRODUCTION

This chapter describes the consolidation of Joint Service non-medical NBC defense requirements and assesses how these programs meet the needs of U.S. forces. The discussion of requirements and the status of research and development assessments is conducted within the framework of the three principles of NBC defense doctrine for the mission area:

- Contamination avoidance
- Protection
- Decontamination

As defined in Joint Publication 3-11, *Joint Doctrine for Nuclear, Biological, and Chemical Defense*, contamination avoidance includes detecting, avoiding, and bypassing contaminated areas. Protection consists of individual and collective protection. Decontamination restores combat power and is essential for sustaining operations in a contaminated environment. Medical support is a critical mission area for operations in an NBC environment. Medical programs support these areas and are discussed in Chapter 3 and Chapter 5, especially Section 5.7.7.

The threat from the continued proliferation of NBC weapons creates a continuous need to ensure that U.S. forces can survive, fight, and win in an NBC threat environment. The increasing danger from these weapons demands that we look for every opportunity to avoid technological surprises. Evolving operational requirements demand that the joint program progressively capture and leverage advances in technology to provide the best in NBC defense equipment for the forces.

The research, development, and acquisition (RDA) goal is to equip the joint warfighting forces with sufficient quantities of the best available equipment and in the shortest time possible in order to win decisively, quickly, and with minimal casualties. As authorized under the Joint Service Agreement for non-medical programs and in cooperation with the Armed Services Biomedical Research, Evaluation and Management (ASBREM) Committee for medical programs, the Army as executive agent coordinates, integrates, and reviews the DoD CB Defense Program. The results of these reviews, conducted with all Services participating, are documented in the Joint Service Modernization and Joint Service RDA Plans. These documents form the basis for the consolidated CB Defense Program Objectives Memorandum (POM).

In coordination with the Commanders-in-Chief (CINCs), the Services decide if a material solution is needed to satisfy a requirement for a war fighting capability. They first look at doctrinal, training, or organizational solutions (non-material solutions), and when these cannot be found, they seek equipment solutions through the materiel acquisition cycle. If a valid need exists, then the research and development modernization process will identify technological approaches which may provide a new system or upgrade an existing system.

During FY99 the Joint Service Integration Group documented the Joint Future Operational Capabilities (JFOC). The purpose of the JFOC is to identify and prioritize Joint User (Services and CINCs) far-term future operational capabilities as expressed in the emerging Joint NBC Defense Concept. The overall intent is to provide enhanced user guidance to the Joint NBC Defense Science and Technology (S&T) community to assist in the NBC S&T program formulation and program execution process. The JFOC will also support the development of new NBC Defense Joint Mission Needs Statements (JMNSs) and future Joint Operational Requirement Documents (JORDs). The prioritized list of JFOCs establishes a clear link between near and long term Joint NBC Defense research and development efforts and user needs. Table 2-1 provides a synopsis of the current JFOC priorities, descriptions, and objectives. The JFOC has become an integral part of the Joint Service NBC Defense Modernization Plan and related science and technology plans, including the Joint Warfighting Science and Technology Plan (JWSTP) and the Defense Technology Area Plan (DTAP). Table 2-2 provides a prioritized list of non-medical NBC defense programs from 1999.

Table 2-1. Prioritized Joint Future Operational Capabilities

- | |
|---|
| <p>1: Contamination Avoidance—An enhanced capability to detect, locate, identify, and confirm the presence or absence of any standard or non-standard NBC hazard. Significantly improve tactical, operational, and strategic NBC situational awareness by rapidly detecting, locating, identifying, confirming and disseminating NBC and toxic industrial material (TIM) detection information to the joint force.</p> <p>2: NBC Battle Management—Capability to access, assimilate and disseminate NBC information from throughout the battlespace via standard, joint service and automatic information/data transmission systems. Enhance warfighter protection by providing the critical link between detection and protection. Commanders at all levels will be provided sufficient, timely information through early and direct warning. Commanders will be able to quickly and effectively quantify the risk associated with various courses of action and provide real-time display with local 3-D digital terrain graphics to portray the current status of the NBC battlespace.</p> <p>3: Collective Protection—To protect the joint force by allowing it to operate safely, at near-normal levels of effectiveness, while under NBC threat, or in NBC, TIM or other environmental hazards area. Enhance filter systems on existing vehicles, aircraft, shipboard, communications vans and other static/mobile structures.</p> <p>4: Restoration Capability—Enhanced capability to provide rapid, effective, and safe removal/neutralization of hazards resulting from NBC or TIM contamination to enable restoration of unit operational capabilities. Protect and sustain the Joint force by rapidly returning equipment and personnel to normal operating modes/efficiencies after exposure to an NBC or TIM contaminated environment.</p> <p>5: Individual Protection—To protect the joint force by allowing it to operate safely, at near-normal levels of effectiveness, while under NBC threat, or in NBC, TIM or other environmental hazards area.</p> |
|---|

Table 2-2. Prioritized Non-Medical NBC Defense Programs

JSIG Priority	Focus Area	Program	Acronym	Joint/ Service Unique
1	IP	Joint Service Lightweight Integrated Suit Technology	JSLIST	Joint
2	CA	Joint Biological Point Detection System	JBPDS	Joint
3	CA	Joint Biological Standoff Detection System	JBSDS	Joint
4	BM	Joint Warning and Reporting Network (includes MICAD)	JWARN	Joint
5	CA	Joint Chemical Agent Detector	JCAD	Joint
6	CA	Joint Service Lightweight Standoff Chem Agent Detector	JSLSCAD	Joint
7	CA	Joint Service Light NBC Recon System (includes CBMS)	JSLNBCRS	Joint
8	CA	Automatic Chemical Agent Detector and Alarm	ACADA	Joint
9	IP	Joint Service Aviation Mask	JSAM	Joint
10	IP	Aircrew Mask Programs - Current (XM 45, CB Helo, AERP)	AMP-C	Joint
11	IP	Joint Service General Purpose Mask	JSGPM	Joint
12	RES	Joint Service Sensitive Equipment Decon	JSSSED	Joint
13	IP	Joint Protective Aircrew Chemical Ensemble	JPACE	Joint
14	CP	Joint Transportable Collective Protection System	JTCOPS	Joint
15	RES	Joint Service Fixed Site Decon (includes JADS & LWPDS)	JSFXD	Joint
16	RES	Sorbent Decontamination System	SDS	Joint
17	CA	NBC Recon System SIP	NBCRS-SIP	Army
18	CA	Biological Integrated Detection System	BIDS	Army
19	CP	Joint Collective Protection Equipment	JCPE	Joint
20	RES	Lightweight Decontamination System	LDS	Joint
21	CA	Long Range Biological Standoff Detection System	LRBDS	Army
22	IP	Protection Assessment Test System	PATS	Joint
23	IP	Chemical Environment Survivability Mask	CESM	SOF
24	IP	M40A1 Series Mask	M40A1	Joint
25	IP	Chemical Environment Survivability Suit	CESS	SOF
26	CA	Joint Service Chemical Warning and Identification LIDAR Detection	JSWILD	Joint
27	CP	Shipboard Collective Protective Equipment	SHIP CPE	Navy
28	CA	Interim Biological Agent Detector	IBAD	Navy
29	CA	Joint Chemical/Biological Agent Water Monitor	JCBAWM	Joint
30	CA	Special Operations Modular Chem/Bio Detector	SOMCBD	SOF
31	RES	Modular Decontamination System	MDS	Joint
32	IP	Joint Service Mask Leakage Tester	JSMLT	Joint
33	CA	Improved Point Detection System	IPDS	Navy
34	CA	Improved Chemical Agent Monitor	ICAM	Army
35	IP	Joint Canteen Refilling System	JCRS	Joint
36	CA	Shipboard Automatic Liquid Agent Detector	SALAD	Navy
37	CA	Scanning Airborne Fourier Emission for Gaseous Ultraspectral Analysis and Radiometric Detection	SAFEGUARD	Joint
38	CA	Chemical/Biological Individual Sampler	CBIS	Joint
39	CA	Pocket RADIAC	AN/UDR-13	Army
40	CA	Chem/Bio Radiological Integrated Detection System	CBRIDS	Joint
41	CA	Stand-off Radiac	JS RADIAC	Army
42	CP	Advanced Integrated Collective Protection System	AICPS	Army
43	CA	Advanced Airborne RADIAC System	AARS	Army
44	CA	NBC Unmanned Ground Vehicle Sensor	NBC UGVS	Joint

Key: BM = Battle Management; CA = Contamination Avoidance; CP = Collective Protection; IP = Individual Protection; RES = Restoration of Operations; SOF = Special Operations Forces

In accordance with the national strategy of achieving and applying technological superiority, several underlying concepts form the foundation of acquisition modernization. The first is the need to reduce cycle time in the acquisition of new systems or the integration of emerging technologies into existing systems. The use of Advanced Concept Technology Demonstrations (ACTDs), open systems and architectures, along with the new emphasis on commercial standards and practices, allow us to shorten the acquisition cycle time. The program acquisition process reduces lifecycle costs through practices such as design-to-cost and concurrent engineering to ensure that equipment is easy to maintain and repair even with the inherent complexity in most new systems.

2.2 NBC DEFENSE MISSION AREA REQUIREMENTS AND RDA SUMMARY

NBC defense programs are categorized broadly under three operational principles: contamination avoidance, protection, and decontamination. Medical defense, a subset of protection, is addressed in the next chapter. The Services have been working closely together to increase jointness in ongoing programs for each of these areas. This report highlights improvements during FY99 and discusses cooperative efforts for further Joint development of requirements. This section summarizes the requirements in each of the mission commodity areas. Tables 2-3 through 2-11 display requirements and acquisition strategies. Since the focus of this chapter is on research and development efforts, fielded items are not included in these tables. Descriptions of developmental and fielded equipment can be found in Annexes A–C of this report.

The following is an overview of the goals and timeframes, potential payoffs, and major technical challenges for specific commodity area science and technology (S&T) efforts. A detailed account of S&T efforts for all commodity areas is provided in two separate reports: (1) the *Joint Warfighting Science and Technology Plan*, especially Chapter XII, “Chemical and Biological Defense and Protection and Counter Weapons of Mass Destruction,” and (2) the *Defense Technology Area Plan*, especially Chapter II, “Chemical and Biological Defense.” The *Basic Research Plan*, also provides descriptions of various supporting sciences—including chemistry, biological sciences, materials science, and others—that support CB defense S&T activities. Within the *Joint Warfighting Science and Technology Plan* and the *Defense Technology Area Plan*, key projects are defined as Defense Technology Objectives (DTOs). A DTO states specific technology advancements to be developed or demonstrated, the schedule, costs, specific warfighter payoffs (stated quantitatively against two or more metrics), and the customers for whom the technology is being developed (*e.g.*, a specific Commander in Chief). DTOs represent only a portion of science and technology base funding, yet represent high priority projects, consistent with strategy and guidance. DTOs provide a key means for S&T planning and programming and for fulfilling GPRA requirements. DTOs are proposed or updated annually.

2.3 CONTAMINATION AVOIDANCE (Detection, Identification and Warning)

The operational concept of contamination avoidance includes NBC reconnaissance, detection, identification, warning and reporting. Earliest possible warning is the key to avoiding NBC contamination. For fixed sites where contamination cannot readily be avoided and for

missions requiring operations in a contaminated environment, detection, identification, and warning are equally critical to ensure that forces can (1) assume the optimal protective posture so that they can continue to sustain operations and (2) rapidly identify and decontaminate affected areas, equipment, and personnel. Sensors for the individual warfighter and systems capable of detecting multiple agents and characterizing new agents are being developed. Advances in technology are being pursued in chemical and biological standoff, early warning detection, miniaturization, interconnectivity, improved detection sensitivity, improved logistics supportability, and affordability. The following sections detail contamination avoidance science and technology efforts, modernization strategy, and Joint Service programs.

2.3.1 Contamination Avoidance Science and Technology Efforts

2.3.1.1 Goals and Timeframes. The goal of contamination avoidance is to provide real-time capability to detect, identify, characterize, locate, and warn against all known or validated CB warfare agent threats below threshold effects levels (see Table 2-3). To meet near term needs a number of sensor technologies are being optimized while alternative detection technologies mature. Mid-term technologies focus on developments to improve tactical detection and identification capabilities for both chemical and biological warfare agents. Far-term science and technology efforts focus on multi-agent sensors for biological agent detection and remote/early warning CB detection. These far-term objective technologies seek to integrate chemical and biological point and remote/early warning detection modules into a single system. Research and Development (R&D) efforts seek to optimize and balance system sensitivity, size/weight, cost, power consumption, signature and false alarm rate. Ultimately the goal is direct integration of CB detectors as a single system into various platforms, and command, control, communication, computer, and intelligence (C⁴I) networks.

As identified in the *Defense Technology Area Plan* and the *Joint Warfighting Science and Technology Plan*, following are Defense Technology Objectives (DTOs) focused on near and mid-term science and technology goals.

Ongoing DTOs:

- Laser Standoff Detection Technology
- Chemical Imaging Sensor
- Biological Sample Preparation System for Biological Identification
- Joint Biological Remote Early Warning System ACTD
- Force Medical Protection ACTD

Completed DTOs (in ACTD Sustainment Phase):

- Airbase/Port Biological Detection ACTD
- Chemical Add-On to Airbase/Port Biological Detection ACTD

DTOs Completed In FY99:

- Joint Warning and Reporting Network
- Integrated Biodetection Advanced Technology Demonstration.

Table 2-3. Contamination Avoidance Science and Technology Strategy

By 2000	By 2005	By 2010
<ul style="list-style-type: none"> • Complete installation of the Portal Shield ACTD biological and chemical detection network at CINC air bases and ports • Complete demonstration of integrated point biodetection capability (Advanced Technology Demonstration) 	<ul style="list-style-type: none"> • Field upgrade (eye safe) Long Range Bio Stand-off Detector in FY00-02. • Joint Biological Remote Early Warning System (JBREWS) ACTD with fielding of ACTD systems to selected CINCs by FY01 • Complete development of Joint Service Light-weight Standoff Chemical Agent Detector (JSLSCAD) • Initiate development of Joint Service Warning and Identification LIDAR Detection (JSWILD) • Complete development of Joint Chemical Agent Detector (JCAD) • Complete development of Block II Joint Biological Point Detection System (JBPDS) 	<ul style="list-style-type: none"> • Demonstrate integration of chemical and biological agent detection modules into a single sensor suite • Complete development of CB water monitor • Complete development of JSWILD

2.3.1.2 Potential Payoffs and Transition Opportunities. Future CB detection systems will provide the capability to detect, identify in real time, map, quantify, and track all known or validated CB contamination in a theater of operations. This will enable commanders to avoid CB contamination, determine the need for and verification of effective reconstitution procedures, and assume the appropriate protection required to continue fighting and sustain their mission with minimal performance degradation and casualties. CB detection technologies have dual use potential in monitoring air pollution, noxious fumes inside enclosed areas, and municipal water supplies.

2.3.1.3 Major Technical Challenges. The major technical challenges are in the areas of biological collection, detection and identification, including remote/early warning sensing, improved agent discrimination and quantification, sample processing, interferent (*i.e.*, false positive and negative alarms) and ambient biological background rejection, and genetic probe development. Size, weight, and power reduction of detectors, power generation and consumption, development of integrated biological and chemical detection systems, and the fusion of sensor data with mapping, imagery, and other data for near real-time display of events are other areas of challenge.

There are two critical needs focused on biological agent detection. Current technologies require a *high level of logistical support* and *lack discrimination in biological standoff detection*. The challenge in reducing logistical support stems from the dependence on reagents and size, weight, and power requirements of the systems. Several efforts are aimed at provide minimum reagent requirements with higher sensitivity, better stability, and fewer supporting reagents, and scientific/engineering strategies to reduce size, weight, and power requirements, especially in the sample collections components. There are several factors directly limiting the ability to discriminate biological agents using standoff (laser) detection technologies. Key factors include: (1) a lack of fundamental data in understanding the spectral properties of biological warfare agents, (2) range limitations of lasers due to atmospheric absorption, and (3) natural background interference. Over the last two years, a number of strategies and concepts have been developed to improve the discrimination capability of standoff detection for biological materials.

Preliminary data developed this past year has shown the potential feasibility of two of these concepts. Further efforts in FY02 and FY03 will begin to validate the feasibility of providing an enhanced level of discrimination of biological material using standoff detection.

2.3.2 Contamination Avoidance Modernization Strategy

The increased lethality and heightened operational tempo of the future battlefield demand responsive NBC detection and warning capabilities in order to reduce force degradation caused by contamination. These capabilities—which also encompass NBC reconnaissance, detection, identification, and reporting—are critical for force readiness and will continue to be emphasized by the DoD community in the near and distant future. Table 2-4 shows the roadmap of DoD requirements for contamination avoidance. While requirements identified in the near-term meet service-specific needs, those in the mid to far-terms demonstrate the increase in joint development and modernization since the founding of the CBDP.

Table 2-4. Contamination Avoidance Modernization Strategy

	NEAR (FY00-01)	MID (FY 02-05)	FAR (FY 06-15)
Chemical Point Detection	<ul style="list-style-type: none"> •Surface off-gas sampling capability (ICAM) •Automatic point detection of nerve and blister agents (ACADA) •Navy-Ship based improved automatic point detection of nerve/blister (IPDS) •Navy-Automatically detect liquid agent shipboard (SALAD) 	<ul style="list-style-type: none"> •Improved, all-agent programmable automatic point detection; portable monitor, miniature detectors for aircraft interiors; interior ship spaces; wheeled and tracked vehicles; and individual soldiers (JCAD) 	<ul style="list-style-type: none"> •Improved surface contamination monitor •Detection of CB contamination in water (Joint Chemical Biological Agent Water Monitor)
Biological Point Detection	<ul style="list-style-type: none"> •Fixed site defense biological detection Portal Shield network sensor system •Automatic long line source and point/mobile biodetection to detect and identify bio-agents; programmable (JBPDS Block I) •Navy-Ship based Interim Biological Agent Detector (IBAD) •Army-Biological Integrated Detection System (BIDS) 	<ul style="list-style-type: none"> •Automatic point biodetection, to detect and identify; programmable (JBPDS Block II) •Joint Biological Remote Early Warning System (JBREWS) - A distributed network of fully automated lightweight sensors. 	<ul style="list-style-type: none"> •Automated, integrated detection of both biological and chemical agents in a single sensor package (Joint Chemical and Biological Universal Detector, JCBUD)
NBC Reconnaissance and CB Remote and Stand-off Detection	<ul style="list-style-type: none"> •Improved NBC Reconnaissance Vehicle with remote/early warning and data fusion capabilities (JSNBCRS) •Army - Long Range Stand-off detection and mapping of aerosol clouds (LR-BSDS) 	<ul style="list-style-type: none"> •Biological remote detection and early warning capabilities (JBREWS) •Lightweight passive stand-off detection for chemical agent vapors (JSLSCAD) •Add biological detection and identification capabilities (JSNBCRS P3I) •Light reconnaissance vehicle (JSLNBCRS) 	<ul style="list-style-type: none"> •Stand-off detection, ranging, and mapping of chemical vapors and aerosols (JSWILD) •Wide area detection •Automated standoff detection of biological agents (JBSDS)
Warning and Reporting	<ul style="list-style-type: none"> •Automated warning and reporting (JWARN Phase I) 	<ul style="list-style-type: none"> •Automatic NBC warning and reporting interoperable with all Services (JWARN Phase II) 	<ul style="list-style-type: none"> •Integrated and automatic warning and reporting (JWARN Phase III)
Radiation Detection	<ul style="list-style-type: none"> •Army-Compact, digital whole body radiation measurement (AN/UDR-13) 		<ul style="list-style-type: none"> •Stand-off radiation detection and measurement •Portable radiation meter

1. All programs shown are joint or multi-service, unless indicated as a Service-unique effort (italicized text).
2. Where applicable, systems which meet requirements are listed following the entry.

Early detection and warning is the key to avoiding NBC contamination. As a result, DoD is concentrating RDA efforts on providing its warfighters real-time capabilities to detect, identify, quantify, and warn against all known or validated CB warfare threats below threshold effects levels. Real time detection of biological agents below threshold effects levels is unlikely in the near to mid-term. Current emphasis is on developing lightweight, automated CB sensors capable of providing enhanced detection and early warning, capable of detecting all known biological and chemical agents. To meet the needs in the near to mid term, several stand-alone detectors and sensors are being developed. Developmental efforts are focusing on system miniaturization, improved sensitivity and specificity, agent characterization and range, decreased false alarm rate, and decreased operation and support costs. This focus will facilitate the integration of chemical detectors into personal warfighter gear, chemical and biological detectors onto various air, sea, and ground platforms, and integration of detectors into automated warning and reporting networks. Table 2-5 provides an overview of RDA efforts and Service involvement.

Table 2-5. Contamination Avoidance RDA Efforts

Category	Nomenclature	Status	USA	USAF	USMC	USN
Automatic Detectors and Monitors	- M22 Automatic Chem Agent Detection Alarm (ACADA)	Production	Joint	Joint	Joint	Rqmt
	- Shipboard Automatic Liquid Agent Detector (SALAD)	LRIP				Rqmt
	- Improved Point Detection System (IPDS)	Production				Rqmt
	- Improved CAM (ICAM)	Production	Rqmt	Interest	Rqmt	Interest
	- Joint Chemical Biological Agent Water Monitor (JCBAWM)	RDTE	Joint*	Joint*	Joint*	Interest
	- Joint Chemical Agent Detector (JCAD)	RDTE	Joint*	Joint*	Joint*	Joint*
	- Biological Point Detection					
	--Interim Biological Agent Detector (IBAD)	Fielded				Rqmt
	--Biological Integrated Detection System (BIDS NDI)	Fielded	Rqmt			
	--BIDS P3I	Production	Rqmt			
- Portal Shield	Production	Joint	Joint	Joint	Joint	
- Joint Bio Point Detection System (JBPDS)	RDTE	Joint	Joint	Joint	Joint	
Remote/ Early Warning	- Joint Service Lightweight Stand-off Chemical Agent Detector (JSLSCAD)	RDTE	Joint	Joint	Joint	Joint
	- Joint Service Warning and Identification LIDAR Detector (JSWILD)	RDTE	Interest	Interest		
	- Biological Stand-off					
	--Joint Remote Biological Early Warning System (JBREWS)	RDTE	Joint	Joint	Joint	Joint
--Long Range Bio Stand-off Detection System-NDI (LRBSDS-NDI)	Fielded	Rqmt	Interest		Interest	
--LRBSDS	RDTE	Rqmt	Interest		Interest	
NBC Recon	- Joint Service NBC Reconnaissance System (JSNBCRS)	RDTE				
	--M93A1 NBCRS/CB Mass spectrometer (See BIDS)	*	Rqmt		Rqmt	
	--Joint Service Light NBCRS/Lightweight Recon System (JSLNBCRS)	*	Joint	Joint	Joint	Interest
Warning and Reporting	- Joint Warning and Reporting Network (JWARN)	RDTE/Prod	Joint	Joint	Joint	Joint
	-- Multipurpose Integrated Chemical Agent Detector (MICAD)	*	Rqmt		Rqmt	
Radiation Detection	- AN/UDR-13 Pocket Radiac	Production	Rqmt	Interest		

Joint= Joint Service requirement
 Rqmt= Service requirement
 Rqmt, Interest= sub-product requirement or interest *= Sub-product(s) of a Joint project
 LRIP= Low Rate Initial Production
 Joint*=Draft Joint Service requirement
 Int-NIR= Service interest, no imminent requirement

The management challenge involves the coordination and consolidation of numerous detection and warning RDA efforts across the Services. This strategy, led by the JSMG through the Contamination Avoidance Commodity Area Manager, resulted in the initiation of RDA efforts which shared common technical goals, but were constrained to Service unique requirements. Management organizations and initiatives, such as the Joint Program Office for

Biological Defense (JPO-BD) and the Joint NBC Defense Board are building Joint Service coordination across the mission area.

Over the past several years, the JSMG and JSIG, through the Contamination Avoidance Commodity Area Manager, with assistance from JPO-BD transformed and consolidated 44 separate contamination avoidance developmental efforts into ten fully coordinated joint projects. The Joint Programs are:

- Automatic Chemical Agent Detection Alarm (ACADA)
- Joint Chemical Agent Detector (JCAD)
- Joint Service Lightweight Standoff Chemical Agent Detector (JSLSCAD)
- Joint Service Warning and Identification LIDAR Detector (JSWILD)
- Joint Biological Point Detection System (JBPDS)
- Joint Biological Remote Early Warning System (JBREWS)
- Joint Service Light NBC Reconnaissance System (JSLNBCRS)
- Joint Warning and Reporting Network (JWARN)
- Joint Chemical Biological Agent Water Monitor (JCBAWM)
- Portal Shield Network sensor system

2.3.3 Joint Service Contamination Avoidance Programs

Consolidation of Joint Service contamination avoidance programs has been completed. All detection programs have been restructured to meet current multi-Service needs. Bolded entries in Table 2-4 highlight Joint programs. Detailed descriptions of Joint contamination avoidance programs are provided in Annex A.

Chemical Warfare Agent Contamination Avoidance. An ACADA non-developmental item (NDI) is being procured for point detection of chemical (nerve and mustard) agent vapors. ACADA is suitable for many vehicle-mounted and man-portable applications. A shipboard version of ACADA, which addresses unique shipboard interferences, is being built to provide the Navy with an interim monitoring capability until JCAD is fielded. The Improved Chemical Agent Monitor (ICAM) is being procured and fielded for post attack monitoring of chemical agent vapors. The ICAM is three times more reliable than its predecessor and much simpler and cheaper to repair. Both the ACADA and ICAM will be replaced by the JCAD.

JCAD provides point chemical vapor detection and is in Phase II (Engineering and Manufacturing Development, EMD) of the acquisition cycle. JCAD will function as a chemical point detection system in order to accomplish a variety of mission requirements on multiple service platforms. The requirements are for the detector to be considerably smaller (within 40 cubic inches) and lighter (2 lbs. or less) than the ACADA and can be configured for a variety of applications, such as individual soldier detectors, post-attack monitoring, shipboard chemical agent monitoring, special operations forces applications, and aircraft interior detection. JSLSCAD provides passive standoff, on-the-move detection of chemical agent vapor and is in Phase II (EMD) of the acquisition cycle. The JSLSCAD program is a joint program with a Joint Operational Requirements Document (ORD) being approved by all Services. The basic

JSLSCAD system (detector, scanner and electronics module) will weigh less than 50 pounds and occupy approximately one cubic foot. The system may be modified to accommodate a variety of requirements, including the addition of a 360° x 60° scanner for Armored Systems Modernization applications (tracked and wheeled vehicles), and a gimbal mount for Marine Corps helicopters and unmanned aerial vehicle (UAV) contamination avoidance roles. The Air Force's primary use for this system will be in air base defense. The Navy will install JSLSCAD on shipboard and airborne platforms and at high priority oversea installations. This system will be fully evaluated by all the Services during EMD.

In the near-term, the Army, Air Force, and Marine Corps have agreed to focus on the development of a Joint Service Light NBC Reconnaissance System (JSLNBCRS). The proposed system will consist of a suite of detectors required for a specific mission that could be easily integrated into the platform of choice. Currently two configurations are proposed: a light and a medium version, to fulfill expeditionary and armored mission profiles, respectively. The FOX NBCRS fulfills heavy requirements. The FOX NBCRS is being upgraded to include a chemical standoff detection capability and other electronic improvements including data fusion.

In the far-term, the Army, Air Force, and Marines have agreed to a Joint Chemical Biological Agent Water Monitor (JCBAWM). JCBAWM is a system that will detect the presence of contaminants in potable water. A requirement for an agent water monitor has been identified by the Army, Air Force, and Marines and a technology base program is underway. The operational scenarios defined in the JCBAWM ORD include source water, water distributions systems, and verification of water treatment. The Army and Air Force have identified a need for a warning and identification detector. The Joint Service Warning and Identification LIDAR Detector (JSWILD) is a technology base effort to address this problem. JSWILD is a laser-based standoff detection system being developed to meet the need for the detection of chemical liquids, aerosols, and vapors. Although this system is much heavier than its passive counterpart (JSLSCAD), it provides the ability to detect chemical agents in all forms—liquids, vapors, aerosols—as well as mapping and ranging information. In addition, JSWILD will provide similar but shorter range (1–5 km) capabilities in biological standoff detection as those developed and fielded for the Long Range Biological Standoff Detection System.

Biological Warfare Agent Contamination Avoidance. Currently, the Joint Program Office for Biological Defense (JPO-BD) manages the following biological detection efforts:

- (1) Interim Biological Agent Detector (IBAD);
- (2) Joint Biological Point Detection System (JBPDS);
- (3) Biological Integrated Detection System (BIDS);
- (4) Long Range Biological Stand-off Detection System (LR-BSDS);
- (5) Air Base/Port Biological Detection (Portal Shield) Advanced Concept Technology Demonstration (ACTD);
- (6) Portal Shield Production;
- (7) Joint Biological Remote Early Warning System (JBREWS) ACTD;
- (8) Critical Reagents Program;
- (9) Technology Transfer Program.

Currently fielded systems include the Navy's shipboard detection system (IBAD), Portal Shield networked systems, and the Army's land-based system (BIDS-NDI). The Army's LR-BSDS is a helicopter mounted infrared LIDAR system for the detection, ranging and tracking of aerosol clouds that may indicate a biological warfare (BW) attack.

In the near-term, the Air Base/Port Biological Detection (Portal Shield) ACTD has developed and demonstrated the capability of networked sensors to protect high value fixed sites against BW attacks. Portal Shield has transitioned into production to meet urgent CINC requirements. JBPDS will be produced to meet each of the four Services' needs for an integrated biological point detector. This program is developing a standard bio detection suite that will be integrated on Service designated platforms. Fielding of the BIDS P3I to the 7th Chemical Company began in 1QFY99 and was completed by 4QFY99. In addition, the Critical Reagents Program consolidates all DoD antibody, antigen and gene probe/primer developments and requirements. This program will ensure the quality and availability of reagents that are critical to successful development, test, and operation of biological warfare detection systems and medical biological products. The Technology Transfer program will ensure the successful and rapid transition of DARPA and other Service breakthrough biological detection technologies into DoD fielded systems.

In the mid-term, the JPO-BD will demonstrate the Joint Biological Remote Early Warning Advanced Concept Technology Demonstration (ACTD). This tactical distributed network system of lightweight, automated sensors will use data fusion to reduce false alarms. The ACTD demonstration test in FY00 will demonstrate enhanced capabilities in detection, identification, and advanced warning of BW attacks.

In the far-term, the concept for the ultimate, joint service chemical and biological detector is the Joint Chemical Biological Universal Detector (JCBUD). JCBUD is envisioned to be a miniaturized, multi-technology, automatic system that may be manned or unmanned, capable of detecting all CW/BW agents, and able to automatically warn troops and report pertinent data relative to a CW/BW attack.

2.3.4 Warning and Reporting

Warning and reporting is a critical component of contamination avoidance. It provides the critical link between CB detection and CB protection and provides situational awareness to the commander. Warning and reporting provides the hardware and software to connect point detection and early warning detection systems into the overall command and control architecture. Additionally, it provides modeling and simulation capabilities to enhance hazard forecasting and assessment. The goal of warning and reporting is to provide sufficient, accurate, and timely information to commanders at all levels through early and direct warning capabilities so they assume appropriate protective postures and develop options to continue mission-essential operations.

The Services have agreed to expedite development of this capability by integrating ongoing hardware and software into a Joint Warning and Reporting Network (JWARN). This

network will be compatible with, but not duplicate, all C⁴I equipment, both current and developmental. The JWARN Phase I effort began fielding the first version of software in FY98. The JWARN Phase II effort was initiated in FY99 into EMD for hardware and software integration onto Service designated platforms and installation at fixed sites.

An integrated warning and reporting network will enhance the overall approach used in the chemical biological defense strategy. The enhancements will come from a warning and reporting network that is linked to numerous point detectors, such as JCAD, which can identify and quantify chemical threats and which are cued by early warning systems, such as JSLSCAD and JSWILD. The information from all the sensor systems in the operational theater becomes available to various command levels with appropriate levels of resolution determined by the command decision needs. For example, a fixed facility commander can determine the appropriate level of protective posture by monitoring the direction of an ongoing attack or how the weather is moving the contamination in a post attack situation.

2.3.5 Other Contamination Avoidance Programs

Various detection and warning requirements have unique mission profiles and technical specifications. While in some instances the development effort may leverage the technical achievements of a closely related detection and warning project, the application beyond its intended mission is limited and accordingly supports only one or a few a specific requirements. The Navy awarded a production contract in FY97 for the Improved (chemical agent) Point Detection System (IPDS), and began installation in FY99. IPDS is used to automatically detect and alarm in the presence of chemical agents in vapor form and will provide continuous detection and alarm capability in the harsh shipboard environment. The IPDS replaces the existing shipboard Chemical Agent Point Detection System (CAPDS) improving detection thresholds, response time, rejection of shipboard interferences, and adding the capability to detect mustard agents. The Navy is also planning on fielding the Shipboard Automatic Liquid Agent Detector (SALAD) in fiscal year 2001. This shipboard system will be used to automatically detect and alarm in the presence of liquid chemical agents. By detecting automatically, it will minimize the sailor's exposure to contamination. As with the IPDS, it will provide continuous detection and alarm capability in the harsh shipboard environment. A performance-based contract for the low rate initial production of SALAD will be awarded in FY00.

The Marine Corps are conducting a Force Medical Protection/Dosimeter ACTD, the goal of which is to develop an individually worn sampler that can measure and archive exposure levels of chemical and biological agents. The goal of the system is to warn the wearer, provide real-time analysis of chemical agents, and trap biological agents for later analysis. The Marine Corps are also developing a Small Unit Biodetector (SUBD), which will have capabilities similar to the JBPDS but will be tailored to the size, weight, and power requirements of the Chem/Bio Incident Response Force (CBIRF).

2.3.6 Defense Advanced Research Projects Agency (DARPA) Programs

There are four related programs currently ongoing within DARPA that contribute to the development of advanced sensor technology: BW defense environmental sensors, tissue-based biosensors, microfluidic molecular systems, and pathogen genome sequencing.

DARPA BW Defense Environmental Sensors Program. DARPA is developing technologies to enable a multiplexing capability for bioagent identification. Technologies using up-converting phosphors provide improved detection sensitivity. Enhanced multiplexing is being developed to reveal BW agent family, genus, and species on a single chip. A mass spectrometer is being miniaturized for potential use in identifying BW agents and contaminants without the use of liquids. These systems will be automated for unattended operations. Detection technologies that provide information on BW agent pathogenicity and viability are also being developed under the DARPA biological detection program.

DARPA Tissue-Based Biosensors Program. DARPA is exploring the use of biological cells and tissues as detector components for sensor devices to report on chemical and biological toxins. Cells and tissues can be used to report on the functional consequences of exposure (mechanism and activity) to a wide spectrum of chemical or biological toxins, whether they are living or dead, or whether they have been bioengineered and currently undetectable by other means (antibodies, nucleic acid sequencing). Technical issues that are being addressed in the program include, (1) the fabrication of biocompatible matrices and interfaces for the long-term retention of cell and tissue function, (2) pattern recognition from critical pathways responsible for the processing of toxins, (3) sampling strategies to accurately extract and present the toxin from air, liquid, or solid samples, and (4) systems integration into a functional device. The current focus of the program is on the use of neuronal and immunological cells and tissues as detectors for such devices. Engineering of cells and tissues of these origins, including stem cells, is proceeding in order to optimize sensor performance requirements and fabricate prototype devices for testing and evaluation.

DARPA Microfluidic Molecular Systems Program. Micro total analysis systems are being developed through focused research on microfluidic, chip-scale technologies. Automated sample collection and sample preparation are key front-end processes for early biological agent detection, whether it is by immunoassays, DNA assays, or tissue-based assays. To scale down these processes into miniaturized, multiplexed detection systems, microfluidic chip-scale components need to be developed. Microfluidic components/devices currently being developed by DARPA include chip-scale micropumps/valves, particle separation filters, fluidic interconnects, fluidic manipulation of hybridized microbeads, controlled mixing/dosing, *etc.* Several demonstrable handheld prototypes, such as a programmable microfluidic system for remote sensors, are currently being tested.

DARPA Pathogen Genome Sequencing Program. DARPA is sequencing the genomes of high threat BW agents. This effort, undertaken with broad community interaction, will support DARPA BW Defense research activities and is intended to satisfy the needs of DoD compo-

nents, the Intelligence Community, and other governmental organizations. Interest is focused on BWD pathogens, and non-pathogenic near neighbors thought to be important to establish a basis for low false alarm detection and identification. The work also contributes to the development of advanced unconventional pathogen countermeasures.

2.4 PROTECTION

When early warning is not possible or units are required to occupy or traverse contaminated environments, protection provides life sustainment and continued operational capability in the NBC contaminated environment. The two types of non-medical protection are individual and collective.

- **Individual protective equipment** includes protective masks and clothing. Protective masks that reduce respiratory stress on the user while improving compatibility with weapon sighting systems and reduce weight and cost are being developed. Technology advances are being pursued to produce mask systems that provide fully compatible vision capabilities, laser/ballistic protection, and further reduction in logistics and physiological burden. Protective clothing and integrated suit ensembles are being developed that will improve protection, reduce the physiological burden, have extended durability, and have less weight and heat stress burden than present equipment.
- **Collective protection equipment** consists of generic NBC protective filters and air movement devices that provide filtered air to a wide range of applications, transportable shelter systems equipped with NBC filtration systems and, in selected cases, environmental control. Collective protection in the form of overpressure, can be applied to mobile and fixed command posts, medical facilities, rest and relief shelters, buildings/fixed sites, vehicles, aircraft, and ships. Lightweight shelters integrated with NBC filtration, environmental control and power generation facilities for medical treatment facilities have been developed and are in production. Technology improvements are being pursued to reduce power requirements and improve filtration capacity against current and future NBC agents. Technologies that reduce weight, volume, cost, and improve the deployability of shelters and filtration systems are also being pursued.

2.4.1 Protection Science and Technology Efforts

2.4.1.1 Individual Protection Goals and Timeframes. The goal of the individual protection area is to reduce the physiological burden associated with wearing protective equipment while maintaining, and potentially improving, the already high level of protection against CB warfare agents and radiological particles (see Table 2-6). Individual protection equipment must also provide protection against emerging threats, such as novel agents or toxic industrial materials (TIMs). To achieve these goals, key physiological performance requirements to the design and evaluation of clothing and respirators are being established. New barrier and filtration materials and selectively permeable materials are being developed and evaluated to accommodate these performance requirements. The primary effort to develop and demonstrate materials for a new generation of lightweight CB protective clothing based on selectively permeable membrane technology is an identified Defense Technology Objective entitled Advanced Lightweight Chemical Protection.

2.4.1.2 Collective Protection (CP) Goals and Timeframes. The goals of the collective protection area are to (1) reduce the weight, size and power requirements of CP systems, (2) reduce

the logistical burdens associated with the maintenance of CP filters, (3) improve protection capabilities against current and emerging threat agents, including TIMs, and (4) improve the deployability of transportable shelter systems (see Table 2-6). To achieve these goals, improvements to system components (including transportable shelters) are being investigated along with improvements to the current vapor and particulate filtration media. Regenerative vapor and particulate filtration materials processes are being investigated to eliminate the need for filter change and improve the capability against any battlespace NBC threats. The primary effort for investigating adsorbents for both single-pass and regenerative filtration applications is articulated in the Defense Technology Objective Advanced Adsorbents for Protection Applications.

Table 2-6. Protection Science and Technology Strategy

By 2000	By 2005	By 2010
<ul style="list-style-type: none"> • Prototype mask with 50% reduced breathing resistance and 50% improved field of vision • Joint Service Lightweight Integrated Suit Technology (Overgarment and MULO), extended durability, reduced heat stress, increased protection • JSLIST P3I, Joint Chemical Ensemble, chemical protective garments, gloves and footwear that are lightweight, and have extended durability and reduced heat stress • Demonstrate a lightweight CB protective duty uniform utilizing selectively permeable membrane technology • Demonstrate regenerative filtration for collective protection applications • Complete evaluation of low cost and lightweight CB tentage materials 	<ul style="list-style-type: none"> • Demonstrate advanced adsorbents to enhance or replace carbon • Demonstrate a duty uniform utilizing selectively permeable membrane/nanofibers that provides integrated environmental protection • Service life indicator • Demonstrate new collective protection shelters utilizing low cost and lightweight CB tentage materials and novel CB resistant tentage closures • Improvements to collective protection systems (JCPE) 	<ul style="list-style-type: none"> • New transportable shelter system (JTCOPS) • Improvements to collective protection systems (JCPE) • Continuous operation filter technology • Demonstrate lightweight, self-detoxifying clothing

2.4.1.3 Potential Payoffs and Transition Opportunities. Individual protection investments will result in improved respiratory and percutaneous (skin) protection with reduced physiological and psychological burden to the individual warfighter. Improved air filtration systems or technologies for collective protection applications will allow for extended operation, in an NBC contaminated environment, reduce the logistics burden associated with filter replacement, reduce weight, volume and power requirements, and improve the capability against current and emerging threats. Filtration technology has commercial application to the chemical industry and automotive applications.

2.4.1.4 Major Technical Challenges. Integrating CB protection into future weapon systems necessitates tradeoffs between performance requirements and limitations of materials and designs. Integral respiratory protection requires tradeoffs between physiological performance parameters such as pulmonary function, field of view, speech intelligibility and anthropometric sizing against constraints such as cost, size/weight, protection time, and interfacing with other equipment. CB protective clothing development requires balancing the physiological burden imposed upon the warfighter with maximum obtainable CB agent protection. Significant

advancements have been made in improving the weight/bulk and power requirements of personal cooling systems, but further work in this area is needed. Air purification systems require tradeoffs with respect to performance, user requirements, size, weight and power constraints, as well as longer life.

2.4.2 Protection Modernization Strategy

Forces cannot always avoid NBC hazards, therefore, individual warfighting units must be provided materiel to protect them from the effects of these lethal agents. Protection must be effective against all known threats with minimal degradation to the performance of personnel, weapons, or equipment. Protective measures allow our forces to maintain combat superiority in NBC contaminated environments. A summary of protection modernization requirements is provided in Table 2-7.

The goal of the protection RDA area is to provide equipment that allows U.S. forces to operate in a NBC contaminated environment with minimal degradation of the warfighters' performance. Near-, mid-, and far-term objectives are to reduce physiological and logistical burdens while maintaining current protection levels. Table 2-8 provides an overview of individual and collective protection RDA efforts and Service involvement.

Protective masks will be improved to reduce fatigue, thus enhancing ability to perform mission tasking. Mask systems will require increased NBC survivability and compatibility with combat or personal equipment. Future respiratory systems, such as the Joint Service Aviation Mask (JSAM) and Joint Service General Purpose Mask (JSGPM) will require enhanced compatibility with life support equipment, tactical systems, and fixed and rotary wing aircraft. In the future, the focus will be on integrated respiratory protective ensembles which offer optimal compatibility with personal, tactical, and crew support systems. Key technologies for future mask systems include mask service life indicator, advanced materials, and improved models and test technologies for protection assessment.

Future protective clothing ensembles for U.S. forces will require reductions in bulk and weight without any loss of protection or durability. To satisfy these needs, the Services have consolidated their mission specific requirements into a first truly joint program for the next generation chemical garments—the Joint Service Lightweight Integrated Suit Technology (JSLIST) program. The JSLIST program developed and is fielding the JSLIST Overgarment and Multi-purpose Overboots (MULO). The goal of the JSLIST Pre-Planned Product Improvement (P3I) is to develop improved chemical protective overgarments, duty uniforms, undergarments, gloves, and socks that will increase protection, reduce physiological burden, and have increased durability beyond those items fielded in the baseline JSLIST program. New accessories, such as gloves and footwear, are required to execute missions and tasks which require greater tactility and traction. The Joint Protective Aircrew Ensemble (JPACE) will be developed to provide aviators with the same advantages and improved protection as JSLIST provides to other warfighters. Similarly, clothing systems for Explosive Ordnance Disposal (EOD) personnel and fire-fighters are required to enhance existing chemical protection systems without undue physiological burdens.

Table 2-7. Protection Modernization Strategy

	NEAR (FY00-01)	MID (FY02-05)	FAR (FY06-15)
Individual Eye/ Respiratory	<ul style="list-style-type: none"> •Voice amplification; laser/ballistic eye protection; improved decontaminability, better comfort (M40A1/M42A2) •Army - <i>Aircrew mask compatible with Apache helicopter systems with a significantly lighter motor/blower unit (M48)</i> •Army - <i>Improved compatibility with aviation sighting/night vision systems; reduced logistics burden using non-blower systems, selected for Land Warrior (M45)</i> 	<ul style="list-style-type: none"> •Reduced physiological burden, improved comfort, enhanced optical and communications, improved compatibility •New mask systems for general purpose and aviation masks (JSGPM, JSAM) •Navy - <i>Improved complete protection for all aircrews (CB Respiratory System)</i> 	<ul style="list-style-type: none"> •Advanced Integrated Individual Soldier Protection system (Future Soldier System) •Improved multiple agent protection
Individual Clothing	<ul style="list-style-type: none"> •Advanced protective suit technology; lighter, improved agent protection; reduced heat stress integrated with all respiratory systems. <ul style="list-style-type: none"> - Improved foot protection (MULO) •Improved protection, less burdensome, protective suits; Improved foot protection/less burdensome; Flame protection (JSLIST P31) •Army - <i>Improved protection for short term use for special purposes (ITAP)</i> •Army - <i>Improved protection with self contained breathing capability for special purposes (STEPO)</i> 	<ul style="list-style-type: none"> •Improved protection (Joint Service Chemical Ensemble) •Improved protection for aviators (JPACE) •Service Life Indicator and CB duty uniform •Improved hand protection 	<ul style="list-style-type: none"> •Integrated multiple threat modular protection (chemical, biological, environmental, ballistic direct energy and flame) •Self-detoxifying clothing
Collective Protection	<ul style="list-style-type: none"> •Chemically Protected Deployable Medical Systems (CP DEP MEDS) •Chemically Hardened Air Transportable Hospital (CHATH) •Marine Corps - <i>Protection for all combat vehicles and unit shelters</i> •Army - <i>NBC protection for tactical Medical units (CB Protective Shelter, CBPS).</i> <ul style="list-style-type: none"> - <i>Apply regenerable vapor filter to Comanche,</i> - <i>Apply collective protection to advanced vehicle concepts.</i> - <i>Modular, reduced size, weight and power for vehicle/ shelter collective protection - Advanced Integrated Collective Protection Shelter (AICPS)</i> •Air Force - <i>Upgrade/install collective protection into existing rest/relief shelters.</i> 	<ul style="list-style-type: none"> •Improved filters to extend filter life, reduce maintenance and reduce logistical burden •Regenerable/advanced protective filtration for vehicles/vans/shelters; reduce logistics burden, improved protection against current and future threats •Lighter, more mobile, easier setup, more affordable shelters (JTCOPS) •Improved current collective protection filters and equipment (JCPE) •Support medical treatment in a CB environment for Airborne, Air Assault, and Heavy Divisions (CBPS) •Navy - <i>Backfit ships with contamination free protected zones - (Selected Area Collective Protection System, SACPS), Integrate collective protection system into V-22</i> 	<ul style="list-style-type: none"> •Family of advanced protective filtration systems for vehicles, shelters, ships, and light forces

1. All programs shown are joint or multi-service, unless indicated as a Service-unique effort (italicized text).
 2. Where applicable, systems which meet requirements are listed following the entry.

Table 2-8. Protection RDA Efforts

Category	Nomenclature	Status	USA	USAF	USMC	USN
	INDIVIDUAL PROTECTION:					
Integrated	- Force XXI Land Warrior	RDTE	Rqmt	Interest	Interest	Interest
Eye/ Respiratory Protective Masks	- MBU-19/P Aircrew Eye/Respiratory Protection (AERP) - M48 Aircraft Mask - CB Respiratory System (A/P22P-14(V)) - M45 Aircrew Protective Mask (ACPM) - M40A1/M42A2 - MCU-2A/P - Joint Service Aviation Mask (JSAM) - Joint Service General Purpose Mask (JSGPM)	Production Production RDTE Production Fielded Production RDTE RDTE	Interest Rqmt Rqmt Rqmt Rqmt Rqmt Rqmt	Fielded Fielded Rqmt Rqmt	Interest Rqmt Interest Rqmt Rqmt Rqmt	Rqmt Rqmt Rqmt Rqmt Rqmt
Ancillary Equipment	- Protection Assessment Test System (PATS) - Voice Communication Adapter	Production Production	Rqmt Rqmt	Fielding Rqmt	Fielded Fielded	Interest Fielded
Battlefield Protective Suits	- CB Protective Overgarment Saratoga - Chemical Protective Undergarment (CPU) - Joint Service Lightweight Integrated Suit Technology (JSLIST/JSLIST P3I) -- Overgarment -- Undergarment (P3I) -- Duty Uniform (P3I) -- Boots (MULO) -- Gloves (P3I) -- Socks (P3I) - Battledress Overgarment (BDO)	Fielded Fielded Prod.* RDTE RDTE MS III* RDTE RDTE Fielded	Interest Rqmt Rqmt Interest Interest Rqmt Rqmt Rqmt Interest	 Rqmt Interest Interest Rqmt Rqmt Rqmt Interest	Fielded Int-NIR Rqmt Interest Rqmt Rqmt Interest	Interest Rqmt
Specialty Suits	- Self-Contained Toxic Environment Protective Outfit (STEPO-I) Interim - STEPO - EOD Ensemble - Improved Toxicological Agent Protective (ITAP) - Joint Firefighter Integrated Response Ensemble (JFIRE)	Fielded Production Production MS III Production	Rqmt Rqmt Rqmt Rqmt Rqmt	 Rqmt	 Interest	 Interest
	COLLECTIVE PROTECTION:					
Tentage and Shelter Systems	- M20A1/M28 Simplified CP Equipment (CPE) - CB Protective Shelter (CBPS) (Medical) - Portable Collective Protection System (PCPS) - CP Deployable Medical System Chemically/ Biologically Hardened Air Transportable Hospital (DEPMEDS/CHATH) - Joint Transportable CP System (JTCOPS)	Fielded Production Fielded Production RDTE	Rqmt Rqmt Rqmt Rqmt	Rqmt Rqmt	Interest Rqmt	Rqmt Interest Rqmt
Collective Protection (CP) Systems	- Shipboard Collective Protection System (CPS) - Shipboard CPE - Modular Collective Protection System (MCPE) - Advanced Integrated Collective Protection System (AICPS) for Vehicle, Vans, and Shelters - Selected Area Collective Protection System (SACPS) - M8A3 GPFU - M13A1 GPFU Joint Collective Protection Equipment (JCPE)	Production RDTE Fielded RDTE Production Fielded Fielded RDTE	Interest Interest Rqmt Rqmt Rqmt Rqmt Rqmt Rqmt	Interest Interest Interest	Interest Interest	Rqmt Rqmt Interest Rqmt Rqmt Rqmt
Generic Filters	- M48/M48A1 (100 cfm) - M56 (200 cfm) - Fixed Installation Filters	Fielded Fielded Fielded	Rqmt Rqmt Rqmt	Rqmt Rqmt Rqmt	Rqmt Interest	Rqmt Rqmt

Rqmt = Product requirement
Interest = Product Interest
Int-NIR = Product Interest, No Imminent Requirement

* - Sub-Product(s) of a Consolidated Joint Service Project
Rqmt, Interest = Sub-Product requirement or Interest

Collective protection equipment (CPE) development efforts are focused on NBC protection systems at the crew, unit, and platform level. New CPE systems will be smaller, lighter, less costly, and more easily supported logistically. New systems are required to provide clean environments for critical operations (*i.e.*, where individual protective equipment (IPE) otherwise places an unacceptable burden upon the warfighter in performing duties) and for essential rest and relief. Modernization efforts will concentrate on: (1) improvements to current vapor and particulate filtration media to extend filter life and to offer improved performance against current and/or emerging threats, (2) advanced air filtration (vapor and particulate) technologies, integrated with environmental control, to greatly reduce the logistical burden and offer greatly improved performance against current and postulated threats, (3) increased application of collective protection systems onto vehicles, vans, shelters, fixed sites, and ships, within the Joint Services, (4) improved transportable shelter system with integrated power/environmental control/filtration, (5) improvements to current collective protection systems to reduce weight, volume, and power requirements, and (6) standardization of filters within the joint services to address storage and procurement concerns. Efforts are in place to support major weapons systems developments, such as the U.S. Navy V-22 Osprey, the U.S. Army's Comanche, Crusader, Bradley, Breacher, Heavy Assault Bridge, Future Scout and Cavalry System, the USMC Advanced Amphibious Assault Vehicle (AAAV), and other advanced weapons platforms.

2.4.3 Joint Service Protection Programs

Joint programs are shown in Table 2-7 as bolded entries. A detailed description of Joint IPE and CPE programs is provided in Annex B.

Individual Protection

Eye/Respiratory. The M40 and M42 series masks (for individuals and armored vehicle crewmen, respectively) are undergoing the final stages of fielding to replace their M17, M9 and M25 series counterparts. The new masks offer increased protection, improved fit and comfort, ease of filter change, better compatibility with weapon sights, and a second skin, which is compatible with Army and Marine Corps protective ensembles. The second skin design also is being reviewed by the Navy and Air Force for potential adoption. The Army, Marines, and Air Force are also fielding the Protection Assessment Test Systems (PATS) to provide users of the M40, M42, and MCU-2/P series masks with a rapid and simple means for validating the fit and function of the mask to ensure readiness. The Navy is evaluating the use of PATS with its MCU-2/P series mask.

The Navy, in coordination with the Marine Corps, is leading an effort to equip all forward deployed fixed and rotary wing aircrew with improved chemical, biological, and radiological (CBR) protection. The CBR ensembles will feature off-the-shelf items, such as the CB Respiratory System. The Army, in cooperation with the Marine Corps, recently completed a product improvement program for the M40 series mask that allows ground crew to aircrew communication. The Air Force continues to field Aircrew Eye-Respiratory Protection (AERP) systems to protect aircrews from CB hazards. This system complements the recently fielded lighter weight aircrew ensemble.

Mid- and far-term research is focused on improved vapor and particulate filtration technology, as well as improved masks for light and special operations forces (SOF). Development will be completed in the mid-term for the Joint Service Aviation Mask and Joint Service General Purpose Mask, which will provide improved eye, respiratory, and face protection against current and future agents. It will maximize compatibility with future weapon systems, be lightweight, and offer modular facepieces to accommodate a variety of mission profiles. Protective mask efforts will focus on supporting specific needs of the Joint Services and integrated warrior programs (Land Warrior, Air Warrior, Mounted Warrior, and Force XXI).

Clothing. In the area of full body protection, the JSLIST program coordinated the selection of advanced technology chemical protective materials and prototype materials. The JSLIST Overgarment and the Multipurpose Overboot (MULO) were adopted by all four services. The JSLIST Overgarment is a 45 day garment (*i.e.*, it may be used for 45 days after the suit has been opened) that provides 24 hours of chemical protection. It is launderable and lighter weight than the Battle Dress Overgarment (BDO). The MULO will replace the black vinyl overboot/green vinyl overboot (BVO/GVO). The MULO is a 60 day boot that provides 24 hours of chemical protection. The boot has increased traction, improved durability, petroleum, oil, and lubricant (POL) and flame resistance, and better chemical protection than the BVO/GVO.

The JSLIST Pre-Planned Product Improvement (P3I) will address requirements not met through the baseline JSLIST program. This program will obtain new material technologies for overgarments and duty uniforms using the existing JSLIST design. Fabric technologies for a chemical protective undergarment and materials and designs for chemical protective socks will also be addressed. This program will develop a 60 day overgarment with desired flame resistance (FR), a 30 day overgarment with required FR, a 30 day duty uniform with desired FR, a 7 day overgarment with desired FR, a 7 day undergarment with desired FR, general purpose gloves, high tactile gloves, and socks. Materials that meet Service's requirements will be placed on a qualified materials list to encourage multi-source competition and to provide surge capability, although no candidate glove materials were found to meet the requirements under this program. In addition, the Air Force is leveraging technology from the JSLIST program in the development of a chemical protective firefighter's ensemble.

In the far-term, efforts will focus on integrated protection. Next generation technology will be directed toward integrating CB protection into a system that will also provide environmental, ballistic, directed energy, and flame protection, as well as reduced physiological burden. A strong emphasis on supporting technologies must continue. Materials that detoxify a broad range of chemical and biological agents on contact, which can be incorporated into fibers, nanofibers, fabrics, and selectively permeable membranes are being developed using biotechnology, electrospinning, and more conventional approaches.

Collective Protection (CP)

The Services currently use the M20A1 Simplified CPE and the M28 shelter liners to provide CP collective protection to existing structures. Environmental control is also being

added to selected applications. The M20A1 CPE provides resistance to liquid agent and allows expansion of protection area and has been fielded. The M28 Simplified CPE has been integrated into CP DEPMEDS and CHATH field hospitals.

CHATH and CP DEPMEDS are joint programs to integrate environmentally controlled collective protection into already fielded Army and Air Force field hospitals in order to sustain medical operations in a CB contaminated environment for 72 hours. Chemical protection is integrated into existing Tent Extendable Modular Personnel (TEMPER)-based medical tents and shelters through addition of M28 Simplified CPE, chemically protected heaters, air conditioners, and alarms. CP DEPMEDS also includes water distribution and latrine systems and alarms. CP DEPMEDS successfully completed an Operational Test 4QFY97, with type classification scheduled for 2QFY00 and fielding in FY01.

The Chemically and Biologically Protected Shelter (CBPS) is a highly mobile, rapidly deployable shelter system designed to be used for Echelon I and II forward area medical treatment facilities. The system is self contained/self-sustaining. It is permanently mounted onto a M1113 Expanded Capacity Vehicle (ECV) with a Lightweight Multipurpose Shelter. The vehicle tows a trailer and generator set. The vehicle transports a CB protected airbeam supported soft shelter, self-contained environmental support and power generation system, a crew of four and gear, and medical equipment. The CBPS presently is in limited production with initial fielding scheduled for 3QFY00 to meet an urgency of need requirement. Further Operational Tests will be performed in FY00 with full type classification following. A preliminary Operational Test was completed 3QFY98. Mid-term objectives are to initiate development of CBPS to support medical treatment for Airborne, Air Assault and Heavy Divisions.

Other near to mid-term collective protection efforts, such as the Advanced Integrated Collective Protection System (AICPS) will provide a compact, integrated package for power, filtration, and environmental control (heating/cooling). AICPS will provide transportability and maintainability enhancements and decrease system set-up times. Joint Collective Protection Equipment (JCPE) will use the latest technologies in filtration, environmental controls, and power generation to improve and/or standardize current collective protection equipment so that it is lighter, more efficient, more affordable and less logistically burdensome. The Joint Transportable Collective Protection System (JTCOPS) will be the next generation lightweight, modular, easily transportable, self-supporting collective protection shelter that will provide relief from psychological and physiological stresses during sustained operations in a contaminated environment. JCPE and JTCOPS will initiate engineering development in FY00. Redesign and concept tradeoff assistance regarding advanced filtration technologies, such as Pressure Swing Adsorption (PSA) and Catalytic Oxidation (CatOx) has been provided to the Comanche, Crusader, USMC AAV, and U.S. Army advanced vehicle efforts. The USAF is currently undergoing a major upgrade to their mobile and fixed site collective protection capabilities.

2.4.4 Defense Advanced Research Projects Agency (DARPA) Protection Programs

There are two related programs currently ongoing within DARPA that further enable the individual warfighter by providing significantly more mobile and flexible water purification and

desalinization systems and better air filtration media. The intent is to demonstrate highly efficient, smaller, lighter, high water-throughput technologies for water purification and desalinization, and to explore pioneering air filtration schemes of high utility to enable new mission scenarios that are critical to the changing battlefield environment. The water desalinization and purification systems would meet Army Operational Requirements (*i.e.*, effectively treat salt and brackish water and NBC contaminated water, purify 0.2 liter water per minute, weigh less than 2 lbs., *etc.*). The proposed man-portable water units will be multifunctional in that they can be used for several functions, such as water purification, power generation and camp stoves. Work in air purification is being conducted to develop simple air filtration/purification systems for the individual that provide significant improvements over the current charcoal filter gas mask technology (which have remained virtually unchanged for over 20 years). The intention is to develop air purification systems for collective protection that will require much less maintenance and greater personal safety than current carbon-based recirculating filters

2.4.5 Other Protection Programs

Programs supporting requirements of a single service are shown in Table 2-7 as italicized entries. A detailed description of IPE and CPE projects is presented in Annex B.

Individual Protection

Eye/Respiratory. The Army is developing the M48 protective mask to replace the M43 series masks. The M48 will be for Apache pilots. It will be lighter and offer enhanced protection and compatibility with night vision and aircrew systems.

In the near-term, the Army will replace the M43 mask for the general aviator with the Aircrew Protective Mask, M45. The M45 is lighter and less expensive than the M43 and features CB protection without the aid of force ventilated air.

Clothing. The Army has approved fielding of the Self-Contained Toxic Environment Protective Outfit (STEPO). STEPO provides OSHA level A protection for Army Chemical Activity/Depot (CA/D), Explosive Ordnance Disposal (EOD), and Technical Escort Unit (TEU) personnel. The Army has also developed an Improved Toxicological Agent Protective (ITAP) ensemble for short term operations in Immediately Dangerous to Life and Health (IDLH) toxic chemical environments (up to one hour), emergency life saving response functions, routine Chemical Activity operations, and initial entry and monitoring activities. The ITAP ensemble incorporates improvements in material and design. It includes a one-hour supplied air bottle system, which can be switched to a filtered air respirator when operators exit the area of high contamination. A Personal Ice Cooling System (PICS) has been developed for use with both the ITAP and STEPO.

Collective Protection

The Navy now includes the Collective Protection System (CPS) on selected spaces of all new construction ships. Currently the DDG-51, LHD-1, AOE-6, and LSD-41 ship classes are

being built with CPS. The Navy also has the capability to backfit CPS on ships already in Service. The Selected Area Collective Protective System (SACPS) has been installed on selected LHA-1 class ships. The Ship CPS Backfit program will backfit selected spaces critical to amphibious ships with CPS starting in FY00. These spaces include hospital areas, command and control areas, and rest and relief areas. In the mid-term, the Navy is designing the V-22 Osprey to be the first Naval aircraft to incorporate CBR protection for both aircrew and passengers. The ability to provide a pressurized, contamination free environment is a design requirement. The Navy Shipboard Collective Protection Equipment (CPE) effort will increase the shipboard particulate filter life (from the current one or two years) to at least a three year service life, through the use of new particulate pre-filter materials and the use of new high efficiency particulate (HEPA) filter media. The Shipboard CPE will thus provide millions of dollars of savings in life cycle costs by reducing shipboard maintenance requirements and providing energy efficient fans.

2.5 DECONTAMINATION

When contamination cannot be avoided, personnel and equipment must be decontaminated to reduce or eliminate hazards after NBC weapons employment. Decontamination systems provide a force restoration capability for units that become contaminated. Modular decontamination systems are being produced to provide decontamination units with the capability to tailor their equipment to specific missions. Technology advances in sorbents, coatings, catalysis, and physical removal will reduce logistics burden, manpower requirements, and lost operational capability associated with decontamination operations. The following sections detail CB decontamination science and technology efforts, modernization strategy, and Joint Service programs.

2.5.1 Decontamination Science and Technology Efforts

2.5.1.1 Goals and Timeframes. The goal of decontamination science and technology is to develop technologies that will eliminate toxic materials without performance degradation to the contaminated object, are non-corrosive, environmentally safe, and lightweight (see Table 2-9). This area includes decontamination of personnel, individual equipment, tactical combat vehicles, aircraft, facilities, and fixed sites. Decontamination technologies currently being pursued include enzymes, catalysts that improve reactivity, decontaminants that are effective in both fresh and brackish water, and improved reactive sorbents. Supercritical fluid technology and non-ozone depleting fluorocarbons are being investigated for sensitive equipment decontamination, while reactive gases are among the technologies being evaluated as a reactive decontaminant for interior spaces of vehicles such as aircraft. Contamination control involves investigating procedures that minimize the extent of contamination pickup and transfer, and maximize the ability to eliminate the contamination pickup on-the-move as well as during decontamination operations. Enzyme-based decontaminants that are nontoxic, noncorrosive, and environmentally safe are being pursued through DTO Enzymatic Decontamination.

Table 2-9. Decontamination Science and Technology Strategy

By 2000	By 2005	By 2010
<ul style="list-style-type: none"> • Demo improved sorbent delivery systems • Aircraft Interior Decon procedures (non-system, Project O-49) • Demonstrate Fixed Site decontaminants 	<ul style="list-style-type: none"> • Sensitive Equipment Decon Systems • Demonstrate enzymatic decon • Fixed Site applicators 	<ul style="list-style-type: none"> • Demonstrate environmentally safe, sensitive equipment decon materials • New self-decontaminating materials • Improved decon material to replace DS2 • Aircraft and other vehicle interior decontamination

2.5.1.2 Potential Payoffs and Transition Opportunities. The payoff from enhanced decontaminants and decontamination systems will be new non-corrosive, non-toxic, non-flammable, and environmentally safe decontamination systems suitable for a timely elimination of CB agents from all materials and surfaces. This ability will allow the forces to reconstitute personnel and equipment more quickly to increase combat efficiency and lessen the logistic burdens. In the future, reactive coatings may allow the continuation of combat operations without the need to disengage for decontamination. Dual use potential for environmental remediation, especially those dealing with pesticide contamination, is being exploited.

2.5.1.3 Major Technical Challenges. There are two principle technical difficulties associated with this effort. The first is the development of decontaminants that are reactive, non-aqueous, non-corrosive, safe to use on sensitive equipment, decontaminate a broad spectrum of chemical and biological agents, and environmentally safe. The second technical difficulty is the development of decontamination systems that effectively clean all surfaces and materials, while at the same time reduce the manpower and logistics burden.

2.5.2 Decontamination Modernization Strategy

Decontamination systems provide a force restoration capability for units that become contaminated. Existing capabilities rely upon the physical application and rinse down of decontaminants on contaminated surfaces. Existing systems are effective against a wide variety of threat agents, yet are slow and labor intensive and present logistical, environmental, material, and safety burdens. In addition, existing systems are inadequate for electronic equipment decontamination, deficient for large area, port, and airfield decontamination, and rely on DS2 and water. To improve capabilities in this functional area, the Joint Services have placed emphasis upon new decontaminating technologies that reduce existing manpower and logistics requirements. These technologies are safer on the environment, the warfighter, and equipment. Table 2-10 shows the roadmap for modernizing decontamination systems in DoD.

Table 2-10. Decontamination Modernization Strategy

	NEAR (FY00-01)	MID (FY02-05)	FAR (FY06-15)
Personal Equipment Decontaminants	•More reactive, high capacity adsorbent (M291/M295)	•Non-caustic, non-corrosive decontaminant for personnel and equipment •Army- <i>Higher efficiency decon methods (Sorbent Decon)</i>	
Bulk Decontaminants	•Non-caustic, non-corrosive, easy to store and manufacture multipurpose decontaminants	•Decontaminants for fixed sites •Navy - <i>Less caustic capability</i>	•Mission tailored decontaminants •Navy - <i>Contamination resistant shipboard materials</i> •Army - <i>Environmentally acceptable replacement for DS-2</i> •Army - <i>Enzymes for chemical agent decontamination</i>
Expedient Delivery Systems		•Auto-releasing coatings; reduces skin contact hazard & labor requirements	•Self-decontaminating auto releasing coatings; reduces man-power and logistic requirements eliminates skin contact hazard
Deliberate Delivery Systems	•High pressure water wash; mechanical scrubber; improved decontaminant dispenser (increased vehicle throughput) •Army - <i>High pressure hot water washing and decontaminate scrubber capability; reduced water, labor, and logistic burden (M21/M22 Modular Decon System)</i>	•Rapid large scale decon capability for fixed sites; reduced manpower and logistic burden •Non-aqueous capability for electronics, avionics and other sensitive equipment	•Vehicle interior decon capability •Supercritical fluid decontamination apparatus •Army - <i>Waterless decon capability for electronics and avionics</i> •Air Force - <i>Sensitive equipment decontamination system for aircraft interiors</i>

1. All programs shown are joint or multi-service, unless indicated as a Service-unique effort (*italicized text*).
2. Where applicable, systems which meet requirements are listed following the entry.

The goal of the NBC decontamination program area is to provide technology to remove and detoxify contaminated material without damaging combat equipment, personnel, or the environment. In FY99 the RDA community worked with the Joint Staff and Services' operations community and prepared a roadmap that integrates RDA efforts with non-RDA efforts. Other efforts include policy, doctrine, standards, and revised tactics, techniques & procedures. Research and development of non-corrosive, all-agent multipurpose decontaminants and decontaminating systems for combat equipment, aircraft, and personal gear remains a priority. Alternative technologies, such as sensitive equipment decontamination methods and large scale decontamination systems attract interest across the four Services. Table 2-11 provides an overview of Joint Service RDA efforts and Service involvement.

2.5.3 Joint Service Decontamination Programs

The Army has developed the M291 skin decontamination kit as a replacement for the M258A1 decontamination kit for all Services, and has introduced the M295 for improved personal equipment decontamination. The M295 provides the warfighter a fast and non-caustic decontamination system for personal gear. A new adsorbent which is more reactive and has higher capacity of absorbing contamination was developed and completed to improve the performance of the M295 kit. The M295 kit filled with the new sorbent will be available for requisition in January 2000.

Table 2-11 Decontamination RDA Efforts

Category	Nomenclature	Status	USA	USAF	USMC	USN
Personnel	- M295 Individual Equipment Decontaminating Kit - M291 Skin Decontaminating Kit	Production Production	Fielded	Fielded Fielded	Interest Fielded	Interest
Combat Equipment, Vehicles, and Aircraft	- M17A2/A3 Lightweight Decontamination System	Production	Fielded	Rqmt	Fielded	Interest
	- M21/M22 Modular Decontamination System (MDS)	RDTE	Rqmt	Int-NIR	Int-NIR	Int-NIR
	- M17 Diesel Lightweight Decontamination System	RDTE		Int-NIR	Rqmt	Interest
	- Joint Service Sensitive Equipment Decon	RDTE	Rqmt	Rqmt	Rqmt	Rqmt
	- Joint Service Fixed Site Decon	RDTE		Rqmt	Rqmt	Rqmt
Decontaminant Solutions and Coatings	- Sorbent Decontamination System and Solution Decontaminants	RDTE	Rqmt	Interest	Rqmt	Interest

Rqmt = Product Requirement
Interest = Product Interest
Int-NIR = Product Interest, No Imminent Requirement

* = sub-Product(s) of a Consolidated Joint Service Project
Rqmt, Interest = Sub-Product Requirement or Interest

In the near- and mid- term, DoD continues to research new multi-purpose decontaminants as a replacement for bulk caustic Decontamination Solution 2 (DS2) and corrosive Super Tropical Bleach (STB). New technologies, such as sorbents, enzymatic foams, and reactive decontaminating systems are being explored and may offer operational, logistics, cost, safety, and environmental advantages over current decontaminants. It should be noted that present ship-board chlorine-based decontaminant solutions pose an unacceptable corrosion risk to Naval aircraft. Current procedures require the use of fresh water and normal aircraft detergent solutions.

In the far-term, the Services are seeking non-aqueous decontamination systems to provide for sensitive equipment decontamination at mobile and fixed sites. Additionally, there is interest and research in coatings which can reduce or eliminate the necessity of manual decontamination. A detailed description of the decontamination projects is provided in Annex C.

2.5.4 Other Decontamination Programs

In the near- and mid-term, the Army is producing the Modular Decontamination System (MDS) to enhance vehicle decontamination. The MDS will support thorough decontamination for ground forces and possess mechanical scrubbing and improved decontaminant dispensing capabilities. It will also offer a reduction in size, weight, logistics burden, and workload requirements over existing decontamination systems. Similarly, the Marine Corps has explored an alternative man-portable decontamination system and is in the process of procuring an M17 Lightweight Decontamination System (LDS) with a diesel engine. The Air Force is upgrading existing M17 LDS to M17A2 versions and expanding sorbent kit inventories to improve operational and personnel decontamination programs.

2.6 NON-MEDICAL CB DEFENSE REQUIREMENTS ASSESSMENT

ISSUE: Advanced technologies and new methods are currently being examined for fixed site decontamination. Follow-up investigations are planned over the next year to determine the requirements necessary to perform decontamination of large areas, including cleaning area to sustain cargo handling operations. Over the past year, the Services have worked together to improve the Joint orientation of NBC defense requirements. The work being accomplished will improve the equipment fielded in the near future. More emphasis needs to be placed on the Warfighting CINCs' requirements as input for equipment research and development. This is necessary to ensure that future equipment meets the needs of the Joint battlespace environment.

SOLUTION: Areas of concern which are addressed under the management improvement initiatives include the following:

- Identifying baseline capabilities as a measure for determining what tactics, techniques, and procedures may be required.
- Focusing and prioritizing chemical and biological detector programs to ensure that resources are leveraging the most promising technologies and are not diluted by excessive Service unique requirements.
- Developing advanced individual protection ensembles that minimally degrade an individual's performance for all tasks performed in contaminated environments.
- Identifying requirements for collective protection programs to ensure that enough assets are available to complete missions in a CB contaminated environment.
- Developing advanced detection capabilities for the purpose of directing decontamination efforts and monitoring the effectiveness of those efforts.
- Identifying an environmentally safe decontaminant and development of a capability to accomplish fixed site and sensitive equipment decontamination.

In FY99 a Science and Technology Decontamination Master Plan was developed that linked technologies with decontamination needs and programs, resulting in a ten year roadmap that illustrated how the science and technology base should transition to engineering development to meet those needs. The Master Plan was an outgrowth of a front end analysis that provided a systematic evaluation of technologies and their applicability to CB decontamination in the areas outlined above.

(INTENTIONALLY BLANK.)

Chapter 3

Joint Medical Nuclear, Biological, and Chemical (NBC) Defense Requirements, and Research and Development Program Status

3.1 REQUIREMENTS

3.1.1 Introduction

Many countries and terrorist groups have acquired the means to produce chemical, biological and radiological weapons and the means to deliver them. NBC proliferation increases the threat to deployed U.S. forces. In response, the U.S. joint medical chemical, biological, and radiological defense research programs' (JMCBDRP) mission is to preserve combat effectiveness by timely provision of medical countermeasures. Countermeasures are developed in accordance with joint service mission needs and requirements in response to chemical warfare (CW) threats, biological warfare (BW) threats, and threats associated with radiological/nuclear warfare (RW) devices. The JMCBDRP has the following goals:

- (1) Provide individual level protection and prevention to preserve fighting strength.
- (2) Maintain technological capabilities to meet present requirements and counter future threats.
- (3) Provide medical management of CW, BW, and RW casualties to enhance survivability, and expedite and maximize return to duty.
- (4) Sustain basic research that provides the knowledge upon which innovative diagnostics, prophylaxes, and therapies are developed.

CW agents are available worldwide and include vesicants (blister agents), nerve, blood, and respiratory agents. BW agents include bacteria, viruses, rickettsiae, and toxins that can be produced by any group with access to a scientific laboratory or a pharmaceutical facility. The primary RW threat is the use of conventional explosives to spread nuclear contamination over a limited area or strategic terrain (including use against reactors or industrial radiation sources) and potentially the use of a single or a small number of crude, Hiroshima-type nuclear weapons. Exposure to multiple threats may result in synergistic effects. Assessment methodologies enable threat evaluation and injury prediction. Medical prophylaxis and treatment strategies reduce the performance decrement, injury, and death of military personnel in the field, thereby enabling them to accomplish their missions, reducing the need for medical resources and decreasing the probability of long term health effects.

The DoD medical NBC defense research and development program has provided numerous products to protect and treat service members. The DoD program to stockpile biological defense products has been smaller than the chemical defense effort, but has received greater emphasis in recent years.

Specific initiatives programmed to improve NBC defense medical readiness include:

- Continued emphasis on NBC medical countermeasures research.
- Identification and testing of medications and therapeutic regimens that reduce the effect of radiation on both bone marrow and the intestinal tract.
- A biological defense immunization policy for U.S. forces and for other-than-U.S. forces.
- Cooperative initiative with the U.S. Food and Drug Administration (FDA) for acceptance of efficacy data derived from animal studies as surrogates for large-scale human efficacy trials to license drugs and biological products that cannot be ethically tested for efficacy in humans.
- A prime systems contractor initiated efforts to develop, license, produce, and store biological defense vaccines.
- Enhanced medical diagnostic capability for diseases/injuries caused by all agents.
- Consequence assessment of sublethal radiation exposure combined with susceptibility to biological and chemical agents.
- Studies to elucidate the toxicity and mechanism of action of novel threat agents, and to determine the effectiveness of current medical countermeasures.
- Studies to evaluate the effects of chronic exposure to low level chemical warfare agents (CWAs).
- Training of health care professionals for the medical management of chemical, biological, and radiological casualties.

3.1.2 Challenges in the Medical NBC Warfare Defense Programs

Medical prophylaxes, pretreatments, and therapies are necessary to protect personnel from the toxic or lethal effects of exposure to all validated threat agents, as well as other anticipated threats. DoD has fielded a number of medical countermeasures that greatly improve individual medical protection, treatment, and diagnoses.

Executive Order 13139 of September 30, 1999 makes it the policy of the United States Government to provide military personnel with safe and effective vaccines, antidotes, and treatments that will negate or minimize the effects of exposure to a range of chemical, biological, and radiological weapons as well as diseases endemic to an area of operations. This executive order establishes the procedures for the administration of investigational new drugs to members of the Armed Forces to include informed consent requirements and waiver provisions.

The DoD complies with the Food, Drug and Cosmetic Act for Drugs and Public Health Services Act Section 351 for biologics to ensure that drug products are safe and efficacious and biological products are safe, pure, and potent. DoD is working closely with the FDA to amend the Code of Federal Regulations (CFR) for New Drug and Biological Products that cannot meet the efficacy studies required by the FDA for product licensure because they are either not feasible and/or cannot ethically be conducted under the FDA's regulations for adequate and well controlled studies in humans. (See 21 CFR Sec. 312.21(2)(b).) DoD presented a proposal to the

FDA’s Vaccines and Related Biological Products Advisory Committee to use animal efficacy data as evidence demonstrating the efficacy of the Pentavalent Botulinum Toxoid (ABCDE). The Advisory Committee recommended that the FDA accept DoD’s proposed animal surrogate data for licensure of the Pentavalent Botulinum Toxoid (ABCDE). The FDA drafted a proposed rule that allows the use of animal efficacy data for those products that either cannot be tested ethically in humans or it is unfeasible to test. This proposed rule has been published in the Federal Register [Federal Register: October 5, 1999 (Volume 64, Number 192)].

Medical NBC defense products are thoroughly tested and evaluated for their safety in accordance with FDA guidelines before administration to *any* personnel. All medical products must be safe to use and not degrade operational performance. In cases where adverse effects are known or possible, a decision must be made—and a risk accepted—of the potential effects of a medical product versus the catastrophic effects of NBC weapons. Even in those cases where efficacy could not be studied in human clinical trials, the safety profiles of the products are well delineated. In many cases, the safety is well understood because the medical products have been widely used to treat other medical conditions. (The anthrax vaccine has been licensed and used since the 1970s to vaccinate veterinarians, textile workers, and others. The Pentavalent Botulinum Toxoid (ABCDE) was administered safely over 10,000 times to laboratory workers prior to its use for military personnel during the Gulf War. Various anti-emetics reduce the effects of radiological exposure have been used to treat cancer patients undergoing radiation therapy.) Several studies performed at the U.S. Army Medical Research Institute of Infectious Diseases demonstrated the efficacy of the licensed anthrax vaccine against inhalation anthrax in the monkey model. Rhesus monkeys were vaccinated with one or two doses of the licensed anthrax vaccine and then challenged with highly lethal levels of spores from the Ames strain of anthrax, the most virulent

strain tested. In all these studies, the anthrax vaccine protected 42 of 43 monkeys against inhalation anthrax while none of a total of 14 controls used in these experiments survived.

The acquisition life cycle of medical products developed by DoD is normally

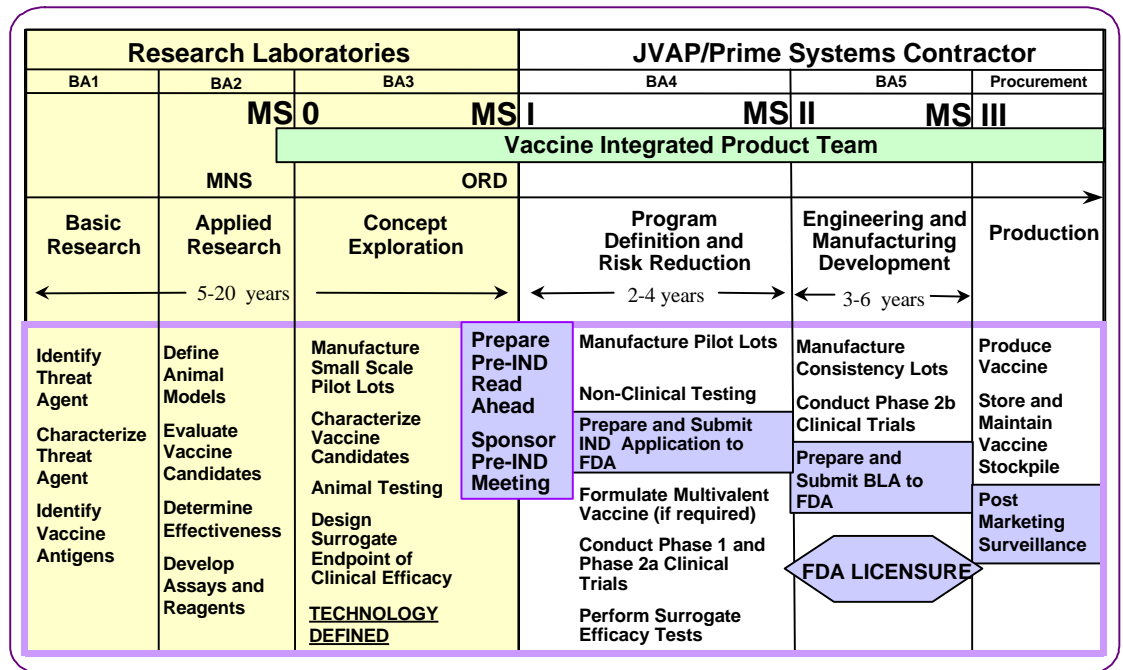

Figure 3-1. Integration of FDA and DoD Milestone Requirements

managed in accordance with the guidelines found in DoD Regulation DoD 5000.2-R. However, since DoD also complies with FDA requirements, it also must follow the requirements of Title

21, Food & Drugs, Code of Federal Regulations for the manufacture, testing, and licensing of medical products. Figure 3-1 illustrates the correlation of FDA requirements for vaccine development with the requirements of DoD 5000.2-R for the life cycle of product development in accordance with DoD acquisition policy.

The medical NBC defense research programs discussed in this section are divided into chemical, biological, and nuclear areas of research. Table 3-6 at the end of this chapter provides a summary of the medical NBC defense programs and the planned modernization strategy over the next fifteen years.

3.1.3 Medical CB Defense Requirements

The Medical Program Sub-Panel (MPSP) of the Joint Service Integration Group (JSIG) was formed in 1998 to prioritize and integrate the Services’ medical NBC defense requirements. The Principals and Action Officers bring significant medical expertise to the panel and have access to the considerable medical expertise across each individual’s Service. Working with the ASBREM helps to assure program consistency and proper application of biomedical research dollars. Table 3-1 below is the first prioritized medical requirements list produced by the MPSP in 1998/99; however, the list prepared for 1999/00 will include requirements to support the POM build.

A memorandum from the Principal Deputy Undersecretary of Defense for Acquisition, Technology, & Logistics asked the JSIG to have the MPSP perform an expeditious review and assessment of smallpox vaccine requirements. This review addressed “several threat scenarios including major theater war, a regional contingency, and CONUS and OCONUS terrorist attacks.” This review resulted in a significant increase in the troop-equivalent dose requirement for the smallpox vaccine.

Table 3-1. CB Defense Prioritized Medical Requirements

Rank	Requirement
1	Diagnostic Kit for Biological Agents and Joint Biological Agent Identification and Diagnosis System (DKBWA/JBAID)
2	Nerve Agent Antidote Delivery System (NAADS), Multi-chambered Autoinjector
3	Smallpox Vaccine
4	Clostridium botulinum Toxin (CBT) Medical Defense System
5	Tularemia Vaccine
6	Venezuelan Equine Encephalomyelitis (VEE) vaccine
7	Topical Skin Protectant
8	Q-Fever vaccine
9	Chemical Biological Protective Shelter (CBPS) System
10	Cyanide Pretreatment
11	Botulism Immune (F(ab') ₂) Globulin Heptavalent, Equine
12	Pentavalent Botulism Toxoid
13	Type F Botulism Toxoid
14	Chemically Protected-Deployable Medical System/Chemically Hardened Air-transportable Hospital (CP-DEPMEDS/CHATH)

3.1.4 Reducing Reliance on Research Animals

In accordance with the FY95 National Defense Authorization Act, which directed DoD to establish aggressive programs to reduce, refine, or replace the use of research animals, the JMCBRDRP utilizes and develops technologies that will reduce reliance on animal research. In FY99, the JMCBRDRP employed computerized molecular modeling, computer predictions, *in vitro* cell cultures, a cell-free reaction system, an *in vitro* model of human skin, and a lipid bi-layer system to replace the use of animals when possible. All research proposals that use animals are evaluated by a statistician to ensure that the minimum number of animals required to obtain scientific validity are used. Animals lower on the phylogenetic scale (or the least sentient species) are used if the selection will permit attainment of the scientific objective. Additionally, all procedures that might cause pain or distress in laboratory animals are reviewed by a veterinarian with expertise in laboratory animal medicine to determine the procedural modifications, analgesics and/or anesthetic regimens to be incorporated to minimize pain or distress. Detailed protocols are comprehensively reviewed and approved by an Institute Animal Care and Use Committee before experiments are initiated; the small percentage of protocols which specify the use of primates undergoes further scrutiny at the USAMRMC Animal Use Review Office. Policies and procedures of the Association for the Assessment and Accreditation of Laboratory Animal Care – International are rigorously enforced and followed. DoD policy states that animal use will be conducted in full compliance with the Animal Welfare Act and that animals are to be used in research only when scientifically acceptable alternatives are not available.

3.1.5 Medical Program Organization

Chemical/Biological. The U.S. Army is the Executive Agent for the Joint Medical Chemical and Biological Defense Research Program (JMCBRP) as prescribed in DoD Directive 5160.5 and, as such, is the lead requirements coordinator. The JMCBRP integrates DoD in-house and external efforts. The Joint Technology Coordinating Group (JTTCG) 3 (Medical CW Agent Defense) and JTTCG 4 (Medical BW Agent Defense) of the Armed Services Biomedical Research Evaluation and Management (ASBREM) Committee are responsible for the programs' joint consolidation, coordination, and integration. The ASBREM Committee maximizes efficiency by coordinated planning, and minimizes unnecessary program overlaps and costly materiel retrofits. (The integration of program management and oversight of medical and non-medical NBC defense programs is described in Chapter 1.) The Army Science and Technology Base Master Plan, the Defense Technology Area Plan, the Joint Nuclear Biological Chemical Defense Research, Development, and Acquisition Plan, and the Medical Science and Technology Master Plan are the program drivers for the chemical and biological research programs. The Joint Service Integration Group (JSIG) established a Medical Program Sub-Panel (MPSP), which is the user representative from the medical community, to establish and direct joint service NBC medical defense program requirements. The science and technology base is managed through the development and execution of Defense Technology Objectives (DTOs). The predevelopment program (basic research, exploratory development, and concept exploration and definition) is directed by the U.S. Army Medical Research and Materiel Command (USAMRMC) through its lead laboratories for medical chemical defense, biological defense, and infectious disease research, U.S. Army Medical Research Institute of Chemical Defense

(USAMRICD), U.S. Army Medical Research Institute for Infectious Diseases (USAMRIID), and Walter Reed Army Institute of Research (WRAIR), respectively. The advanced development program (Program Definition and Risk Reduction [PDRR]) and Engineering and Manufacturing Development (EMD) for medical *chemical* defense products is directed by the U.S. Army Medical Materiel Development Activity (a USAMRMC asset). The advanced development program (PDRR and EMD) for medical *biological* defense products is directed by the Joint Program Office for Biological Defense (JPO-BD). The Joint Vaccine Acquisition Program (JVAP) is an ACAT II program under JPO-BD to transition candidate biological defense vaccines from research laboratories to the Prime Systems Contractor for the development, testing, licensure, production, and storage of vaccine stockpiles.

Nuclear. The study of the medical and biological effects of ionizing radiation is performed by the tri-service Armed Forces Radiobiology Research Institute (AFRRI). AFRRI programs are integrated into other DoD in-house and external efforts under the coordination of the ASBREM. JTCG 7 (Medical Radiological Defense) of the ASBREM Committee is responsible for program consolidation, coordination, and integration. Specific requirements and program tasking for AFRRI research comes from the individual services, Joint Staff, and the Defense Technology Objectives (DTOs) through the authority of a Board of Governors (BOG) with funding from the Director, Defense Research and Engineering. AFRRI is under the administrative control of the Uniformed Services University of the Health Sciences. Members of the AFRRI BOG include representatives of Under Secretary of Defense for Acquisition, Technology, and Logistics, the Assistant Secretary of Defense for Health Affairs, the Surgeons General of the Army, Navy, and Air Force, and the Deputy Chiefs of Staff for Operations of the Army, Navy, and Air Force, or their designated representatives. Major inputs to AFRRI research requirements are driven by the biennial Army Specific Military Requirements compiled by the U.S. Army Nuclear and Chemical Agency.

3.2 JOINT MEDICAL CHEMICAL DEFENSE RESEARCH PROGRAM

The mission of the Joint Medical Chemical Defense Research Program (JMCDRP) is preserve the health, safety, and combat effectiveness of warfighters by timely provision of medical countermeasures in response to joint service chemical warfare defense requirements.

3.2.1 Goals

The goals of the JMCDRP are the following:

- Maintain technological capability to meet present requirements and counter future threats:
 - Determine sites, mechanisms of action and effects of exposure to CWAs.
 - Exploit neuroscience technology and dermal pathophysiology to identify mechanism of action of CWAs.
 - Identify sites and biochemical mechanisms of action of medical countermeasures.
 - Exploit molecular biology and biotechnology to develop new approaches for

- medical countermeasures.
- Exploit molecular modeling and quantitative structure-activity relationships supporting drug discovery and design.
- Provide individual-level prevention and protection to preserve fighting strength:
 - Develop improved prophylaxes, pretreatments, antidotes, and therapeutic countermeasures.
 - Develop skin protectants and decontaminants.
 - Identify factors that influence safety and efficacy properties of candidate countermeasures.
 - Develop and maintain preformulation, formulation, and radiolabeling capabilities.
- Provide medical management of chemical casualties to enhance survival and expedite and maximize return to duty:
 - Develop concepts and recommend therapeutic regimens and procedures for the management of chemical casualties.
 - Develop diagnostic and prognostic indicators for chemical casualties.
 - Provide education on medical management of chemical casualties.

3.2.2 **Objectives**

The objectives of the JMCDRP differ with the varying threats:

- For vesicant (or blister) agents, the objective is to develop a pathophysiological database on vesicant chemical agents and a working hypothesis on how damage occurs at the cellular level. Used with associated technologies, this approach will enable the formulation of definitive pretreatment and treatment strategies, and is expected to produce a realistic concept for medical prophylaxis, immediate post-exposure therapy, and topical protection. Alternatively, in dealing with liquid agent threat, reactive topical skin protectants (rTSPs) can be developed that will protect the skin and simultaneously detoxify the agent.
- For nerve agents, an objective is to field a safe and effective advanced anticonvulsant nerve agent antidote superior to the currently fielded anticonvulsant (diazepam). The advanced anticonvulsant will be more water soluble, will terminate seizures more quickly, and will prevent seizure-induced brain damage and subsequent behavioral incapacitation. Another objective is to field an advanced pretreatment effective against all nerve agents based on physiological scavengers such as the human enzymes butyrylcholinesterase (BuChE) or carboxylesterase (CaE). Ideally the prophylactic would not require any follow-on treatment, and would have no adverse side effects. These naturally occurring enzymes, as well as acetylcholinesterase, are targets for nerve agents. Through bioengineering efforts, human BuChE and CaE have been mutated to forms that are not only less susceptible to inhibition by the nerve agents, but have the added capability to

catalyze nerve agent breakdown. Another potential chemical warfare agent scavenger is human paraoxonase. This enzyme also is being bioengineered to make it more effective and decrease the time it takes to destroy nerve agent.

- For blood agents, the objective is to examine the safety and efficacy of methemoglobin-formers or sulfide donors for cyanide pretreatment.
- For respiratory agents, the objective is to develop prophylaxes and therapies by understanding pathophysiological changes after agent exposure.

3.2.3 Threats, Countermeasures, Technical Barriers, and Accomplishments

The chemical warfare threats and countermeasures, as well as chemical defense research and development technical barriers and accomplishments, are outlined in Annex D (Section D.1). Countermeasures and diagnostic techniques for chemical weapons are shown in Table 3-2. Critical issues of medical chemical defense include the ability to protect U.S. warfighters from the very rapidly acting nerve agents and persistent vesicating agents as well as choking agents and respiratory agents. New threats are also emerging. The effectiveness of current therapeutics against novel threats is a current countermeasure under investigation.

Table 3-2. Medical Chemical Defense Countermeasures and Diagnostic Techniques

- **Chemical Warfare Agent (CWA) Scavengers** – Human enzymes that have been genetically engineered to destroy nerve agents are being developed as nerve agent scavengers.
- **Advanced Anticonvulsant** – Benzodiazepines that are water soluble and long acting are being evaluated for control of nerve agent-induced seizure activity.
- **Reactive Topical Skin Protectant** – Reactive barrier creams are being developed that can not only prevent penetration of CWA but will also destroy them.
- **Antivesicants** – Countermeasures that provide reduction in mustard-induced edema, corneal opacity, and dermal histopathology are being evaluated.
- **Effects of exposure to non-lethal levels of CWA** –The probability and severity of chronic medical effects of single and multiple low-level exposures to CWA are being evaluated.
- **Novel Threat Agents** –Current medical regimens used for protection against the conventional nerve agents are being evaluated as a countermeasure for novel threat agents.
- **Cyanide Countermeasures** – Methemoglobin formers and sulfide donors are being evaluated for safety and efficacy as pretreatments for cyanide intoxication. A non-invasive methemoglobin/cyanide monitor is being transitioned for development.
- **Chemical Casualty Management** - Technologies to assist in the diagnosis, prognosis, and management of chemical casualties are being developed.
- **Respiratory Agent Injury** –Mechanisms of respiratory agent injury are being determined and medical countermeasures for respiratory agent casualties are being developed.

3.3 JOINT MEDICAL BIOLOGICAL DEFENSE RESEARCH PROGRAM

The mission of the Joint Medical Biological Defense Research Program (JMBDRP) is to develop medical countermeasures to protect U.S. forces and thereby deter, constrain, and defeat the use of biological agents against them (DoD Directive 5160.5, May 1985). The program is directed against agents of biological origin that are validated military threats. A primary concern is the development of vaccines, drug therapies, and diagnostic tools, and other medical products that are effective against agents of biological origin.

3.3.1 Goals

Goals of the JMBDRP include the following:

- Protecting U.S. forces' warfighting capability during a biological attack.
- Reducing vulnerability to validated and emerging threats by maintaining a strong technology base.
- Providing education on medical management of BW casualties.

3.3.2 Objectives

In accomplishing the goals of the JMBDRP, efforts are focused on three objectives:

- Maintaining technological capability to meet present requirements and counter future threats:
 - Determine sites, mechanisms of action, and effects of exposure to biological warfare agents with emphasis on exploitation of molecular science.
 - Identify sites and biochemical mechanisms of action of medical countermeasures.
 - Exploit molecular biology and biotechnology to develop new approaches for medical countermeasures.
 - Exploit molecular modeling and quantitative structure-activity relationships supporting drug discovery and design.
- Providing individual-level prevention and protection to preserve fighting strength:
 - Develop improved vaccines, pretreatments, antidotes, and therapeutic countermeasures.
 - Identify factors that influence safety and efficacy properties of candidate countermeasures.
- Providing training in medical management of biological casualties to enhance survival and expedite and maximize return to duty:
 - Develop concepts and recommend therapeutic regimens and procedures for the management of biological casualties.
 - Provide education on medical management of biological warfare casualties.

One of the key efforts to achieve the goals and objectives of the medical biological

defense program has been the protection of U.S. forces against anthrax — a deadly biological warfare agent. This is being accomplished through total force vaccination against anthrax, as described in Table 3-3.

Table 3-3. Anthrax Vaccine Immunization Program (AVIP)

Detailed information on the AVIP may be found on the internet at <http://www.anthrax.osd.mil/>

This web site provides detailed account on the nature of threat from anthrax (*Bacillus anthracis*), description of the vaccine, explanation of U.S. policies regarding biological defense vaccines, U.S. policies regarding the anthrax vaccine, immunization schedule, information on adverse event reporting, and other information related to the AVIP.

As of January 27, 2000, approximately 399,542 members of the U.S. Armed Forces have received at least their initial vaccination and more than 17,066 have completed the 6-shot series. The total force is scheduled to have received the entire series of six shots by 2005.

The JMBDRP responds to requirements from the DoD as identified in the Joint Service Agreement on Biological Defense, the Joint Warfighting Science and Technology Plan, the Defense Technology Area Plan, the Defense S&T Strategy, and DoD Directive 6205.3, “Biological Defense Immunization Program”.

Highly sophisticated technology base efforts for medical biological defense hold the promise of yielding important new products to protect our troops against a wide range of biological threat agents. These products include multi-agent vaccines that will reduce costs of vaccine production and simplify immunization schedules, and a common diagnostic system that can be deployed at forward sites to rapidly analyze clinical samples for the presence of biological warfare agents as well as infectious diseases of military importance. The development of these products, as well as the complementary technology-based research and development to enhance and expand these capabilities and to identify and develop new capabilities, is also being supported by collaboration with other agencies, including the Defense Advanced Research Projects Agency (DARPA) and the Department of Energy (DOE).

Projects and technologies shared with the DOE are related to the strengths of DOE laboratories in developing advanced technologies in order to enable rapid detection of and response to a chemical or biological incident. While DOE focuses internal technology development efforts on the domestic threat, they actively support the DoD. The work spans DNA sequencing and biodetection to modeling and simulation, collaborating on projects such as x-ray crystallography and nuclear magnetic resonance imaging of BW agent antigens. The DNA sequencing efforts have led to advances in developing “lab on a chip” diagnostic technology for several BW threat agents. DOE is not involved in protection and treatment of personnel, but they are assisting DoD with drug/chemical database searches with the intent of identifying novel inhibitors of pathogens.

The DARPA BW defense program includes collaborating with USAMRMC on new platforms to enhance delivery and effectiveness of multi-agent vaccines (for example, stem cells genetically programmed to express antigens sequentially in order to provide automatic boosters in the body). Multi-agent vaccines are similar to the measles-mumps-rubella vaccine administered

to children except that the technologies being explored for producing these new vaccines are more advanced, relying on bioengineering technologies such as naked DNA and the replicon-based delivery systems. Research within USAMRMC in both the naked DNA and replicon approaches is advancing rapidly with demonstration of a multi-agent vaccine planned for FY03.

Bioengineering techniques are also being used to prepare a variety of recombinant vaccines against single threat agents that will be produced without the need to grow the actual threat agent during the vaccine production process. Several recombinant vaccines are scheduled to be fielded over the next 10 years.

Development of a common diagnostic system is proceeding with the adoption of rapid nucleic acid analysis methods. Three configurations of portable instruments using common polymerase chain reaction (PCR) chemistries were demonstrated for the identification of biological warfare agents and naturally occurring infectious diseases. With these tools, laboratory-based identification of infections will be made much faster (less than 30 minutes) and farther forward than is now possible. The development of technologies for common diagnostic systems is jointly supported by DARPA.

The JMBDRP includes the following areas of research:

Pre-exposure Countermeasures: This area involves prophylactic measures undertaken to prevent illness and injury associated with exposure to bacterial, viral, and toxin threat agents. The primary focus of pre-exposure therapy is efforts to produce effective vaccines. The roles of various factors in stimulating cellular and humoral immunity are determined through study of specific genes or properties of threat agents. This knowledge provides tools for development of second-generation recombinant or multi-agent vaccine candidates as well as pretreatment therapies to intervene in the pathogenic effects of threat agents.

Post-exposure Countermeasures: Research efforts in this area are focused on developing safe, effective treatments to alleviate disease or injury associated with exposure to bacterial, viral, or toxin threat agents. Therapeutic measures may involve administration of antimicrobials, anti-toxins or generic compounds formulated to intervene at the pathogen's site of action. The knowledge necessary to develop such products requires in-depth research in the basic pathogenesis and physiology of the BW agents. These analyses will afford researchers tools to create a universal approach in treating post-exposure casualties of a BW attack.

Diagnostics: Diagnostics research involves the investigation and evaluation of sensitive and specific methods for detection of infectious organisms, toxins, antigens and antibodies in biological materials to include the application of nucleic acid probes or synthetic antigens. Rapid identification tests and diagnostic methods for the assay of toxins, metabolites, and analogs in clinical specimens are major goals of this program area.

3.3.3 Threats, Countermeasures, Technical Barriers, and Accomplishments

A biological threat agent is defined as an intentionally disseminated living microorganism

or toxin that can cause disease or death in humans, animals, or plants. Threat agents include a broad range of microorganisms (bacteria, rickettsiae, and viruses) and toxins of biological origin. Biological weapons are easy to make, difficult to detect, and can be very effective. Defense against this class of weapon is difficult, particularly when biological agents can produce casualties over an area of thousands of square kilometers. Biological agents could also be used with devastating effect in combination with nuclear, chemical, or conventional weapons.

Countermeasures and diagnostic techniques for biological weapons are shown in Table 3-4. Critical elements of medical biological defense include the ability to protect U.S. forces from BW agents, to rapidly diagnose (in clinical specimens) infection or intoxication from agents, and to treat casualties. Currently, the most effective countermeasure is pre-deployment active immunization. Future threats, however, may involve genetically engineered biological weapons that may be easily produced, highly lethal, difficult to detect, and resistant to conventional therapies.

The current JMBDRP includes the following research areas for the development of medical countermeasures:

- Characterize the biochemistry, molecular biology, physiology, and morphology of BW threat agents.
- Investigate the pathogenesis and immunology of the disease.
- Determine the mechanism of action of the threat agent in an animal model system.
- Select antigen(s) for candidate vaccines.
- Develop and compare potential vaccine candidates and characterize their effects in animal models.
- Establish safety and efficacy data for candidate vaccines.
- Develop medical diagnostics to include far forward, confirmatory, and reference lab.
- Develop chemo/immunotherapeutic agents and preparations.

Technical shortcoming in the private sector include (1) the lack of high-level biological containment (BL-3 and BL-4) laboratory facilities to support biological defense research, and (2) scientific expertise in biological defense. These factors restrict the depth of expertise, facilities, and support available. A recent redress of funds and authorizations over a six year period (FY99-05) will be used for DoD facility upgrades and to maintain scientific and technological expertise.

Details of the biological warfare threats and countermeasures, as well as biological defense research and development technical barriers and accomplishments, are presented in Annex D (Section D.2).

Table 3-4. Medical Biological Defense Countermeasures and Diagnostic Techniques

<p>VACCINES</p> <ul style="list-style-type: none"> • <i>Killed</i> – killed or inactivated microorganism that is incapable of replicating but stimulates immunity. • <i>Live, attenuated</i> – live organism, genetically selected not to cause disease but able to stimulate immunity. • <i>Toxoid</i> – toxin protein treated to inactivate its toxicity but retains its ability to stimulate immunity. • <i>Recombinant</i> –gene coding for a protein that stimulates specific immunity to a BW agent is inserted into biological vector for production. Protein may be produced in high yields through bioengineering. • <i>Deoxyribonucleic Acid (DNA)</i> –section of DNA that codes for protein that stimulates specific immunity to a BW agent. DNA produces the desired protein in recipient which stimulates immunity. • <i>Polyvalent</i> – mixture of antigens that protects against a number of different BW agents. • <i>Vectored</i> –carrier organism bioengineered to confer immunity against an unrelated BW agent or multiple agents. <p style="text-align: center;">ANTIBODY (ANTISERUM, ANTITOXIN)</p> <ul style="list-style-type: none"> • <i>Heterologous</i> –antibodies collected from animals (<i>i.e.</i>, different species than the recipient) repeatedly immunized against the BW threat. These antibodies must be treated to reduce the human immune response to them (serum sickness). • <i>Homologous</i> – antibodies of human origin (<i>i.e.</i>, same species as the recipient) that provide protective immunity against the BW threat. These antibodies are not prone to stimulating serum sickness. • <i>Monoclonal</i> – a cell culture technique for producing highly specific antibodies against a disease agent. • <i>Bioengineered</i> – antigen binding site on the variable portion of an antibody elicited in a nonhuman system is combined with the nonvariable portion of a human antibody to produce a “humanized” antibody. <p style="text-align: center;">DRUGS</p> <ul style="list-style-type: none"> • <i>Antibiotics</i> – very effective against bacteria, but are ineffective against viruses and toxins. • <i>Antiviral compounds</i> –Promising drugs in development by the pharmaceutical industry are being evaluated against biological threat viruses • <i>Others</i> – compounds that offer new possibilities for protecting against and treating exposure to BW agents (such as drugs to treat toxins or nonspecific treatments such as immunomodulators.) <p style="text-align: center;">DIAGNOSTIC TECHNOLOGIES</p> <ul style="list-style-type: none"> • <i>Immunological technologies</i> – These tests rely on antibodies for detecting the presence of proteins associated with the BW agent. They are easy to use, compact, rapid (minutes), and require little logistic support. This technology is currently used in out-patient clinics and doctor’s offices. • <i>Nucleic acid technologies</i> – nucleic acid tests, specifically the polymerase chain reaction (PCR), rely on segments of genes unique to BW agents to detect the presence of those agents. These tests are extremely sensitive and specific, but currently require more support to perform.
--

3.3.4 Defense Advanced Research Projects Agency (DARPA) Programs

As one of the major program areas, DARPA is pursuing the demonstration and development of new biological warfare defense capabilities. Major thrusts include real-time (environmental) sensing (described in Chapter 2); medical countermeasures (developing barriers to prevent entry of pathogens into the human body and developing pathogen countermeasures to block pathogen virulence and to modulate host immune response); Advanced Medical Diagnostics for the most virulent pathogens and their molecular mechanisms; and Consequence Management Tools.

Medical countermeasures research includes: (1) multi-agent therapeutics against known, specific agents, and (2) therapeutics against virulence pathways (mechanisms of disease) shared by broad classes of pathogens. Specific approaches include modified red blood cells to sequester and destroy pathogens, modified stem cells to detect pathogens and to induce immunity or produce appropriate therapeutics within the body, identification of virulence mechanisms shared by pathogens, development of novel therapeutics targeting these mechanisms, and efficacy testing in cell cultures and animals.

Early diagnosis is key to providing effective therapy against BW agents since many of these agents cause early nonspecific flu-like symptoms. The goal of the DARPA Advanced Medical Diagnostics thrust is to develop the capability to detect the presence of infection by biological threat agents, differentiate from other significant pathogens, and identify the pathogen, even in the absence of recognizable signs and symptoms (when the pathogen numbers are low). Specific accomplishments are listed in Annex D.

Mission effectiveness requires rapid, correct medical responses to biological threats. The objective of the Consequence Management thrust is to provide comprehensive protocols to protect or treat combatants by using current and emerging biological countermeasures. It will provide accelerated situational awareness for biological agents events by detecting exposure to agents through an analysis of casualty electronic theater medical records, and will locate and determine the most effective logistical support for providing appropriate treatment and pathogen-specific resources required to mitigate effects of the attack.

3.4 MEDICAL NUCLEAR (RADIOLOGICAL) DEFENSE RESEARCH PROGRAM

The mission of the Medical Nuclear Defense Research Program (MNDRP) is to conduct research in the field of radiobiology and related matters essential to the support of DoD and the Military Services. The sole repository of defense radiobiology expertise is AFRRI.

3.4.1 Goals

The goals of the MNDRP are the following:

- Understand the pathological consequences of radiation injury in order to guide development of pharmacological agents for mitigating injury.
- Develop medical countermeasures for acute, delayed, and chronic radiation injury.
- Develop and test prophylactic drugs to reduce the adverse health consequences of sublethal radiation exposures.
- Identify biological markers and develop rapid assay systems to assess radiation injury under field environments and enhance medical management of radiological casualties.
- Quantify and build into casualty prediction models the morbidity and mortality due to combined exposure to ionizing radiation and infectious disease or chemical agents.
- Sustain combat capability, increase survival, and minimize short- and long-term problems associated with ionizing radiation when combined with other mass casualty weapons or battlefield stressors such as traumatic injury and endemic disease.

3.4.2 Objectives

The primary objective of this research group is to address the major aspects of military operational requirements for dealing with radiation injuries. A nuclear threat agent is any weapon that causes detrimental medical effects by either direct external irradiation or by internal contamination with radioactive material. These agents include radiation dispersal weapons, which scatter radioactive material with conventional explosives; deliberate area contamination; destruction of a nuclear power plant; improvised nuclear devices; and traditional nuclear weapons. Operational requirements include programs in casualty management, medical radioprotectants to diminish radiation injury, medical therapeutic regimens, biodosimetry, combined NBC injury effects and its mitigation, maintenance of performance, and radiation hazards assessment.

3.4.3 Threats, Countermeasures, Technical Barriers, and Accomplishments

The deployment of a relatively low-yield nuclear device is increasingly possible by a terrorist group or third-world country. If counterproliferation and intelligence efforts fail to deter deployment, medical remediation of casualties must be available. Such a device would most likely be utilized against either a military installation or a political target (*e.g.*, the seat of government, large population center, or commercial port city). In such a scenario, citizens outside the immediate lethal area would be exposed to the prompt radiation of the initial explosion as well as to chronic exposures resulting from the residual radioactive fallout.

The nuclear weapons inventory of current adversaries is thought to be small, but if a weapon is used for military advantage, concomitant use of biological or chemical weapons should be anticipated. Radiation dispersal events could include the destruction of a nuclear reactor, intentional contamination of a battlefield with nuclear waste, or dispersal of radiological materials in a terrorist car bomb attack involving conventional explosives. Most casualties in these scenarios would suffer non-lethal doses of external irradiation. This would complicate the management of their conventional injuries and could cause internal contamination with radionuclides. Prompt effects of moderate- to high-dose radiation injury diminish the soldier's ability to fight and survive. Effective radiation countermeasures must protect the soldier from performance decrement and simultaneously diminish lethality and the long-term health effects of radiation injury. Prophylactic and therapeutic applications of novel pharmacological agents will increase survival and diminish morbidity of individual soldiers wounded by radiation. A research program to understand molecular and cellular damage induced by radiation is needed to determine the best medical countermeasures for the newly arising radiological threats on the modern battlefield. Table 3-5 presents an overview of countermeasures to radiological exposure and research accomplishments during FY99.

Table 3-5. Medical Nuclear Defense Countermeasures

<p style="text-align: center;">PRETREATMENTS</p> <p><i>Single agents:</i> Injections of androstene steroid, vitamin E and/or amifostine (Ethyol[®]) enhance survival of acutely irradiated laboratory animals.</p> <p><i>Multidrug combinations:</i> Enhanced survivability has been shown in animal models using pretreatments (e.g., androstene steroids, amifostine, etc.) followed by postexposure cytokine treatments. Sustained and effective delivery of prophylactic drugs was demonstrated in animal models using implanted capsules. These are single agents used in consecutive manner.</p> <p style="text-align: center;">MEDICAL THERAPIES</p> <p><i>Blood Forming Cell Stimulants:</i> Granulocyte colony stimulating factor (G-CSF, Neupogen[®]) granulocyte-macrophage colony stimulating factor (GM-CSF, Leukine[®]) have been demonstrated to be highly effective in restoring the immune competence of the bone marrow and allowing survival from radiation injuries previously considered lethal. The cytokine thrombopoietin has been developed as a therapeutic agent and is undergoing further trials as a platelet-formation stimulant. Interleukin 11 (IL-11, Neumega[®]) has moderate thrombopoietic activity and is currently available for human use.</p> <p><i>Broad Range Cellular Recovery Stimulants:</i> Research continues into biologically stable compounds that stimulate recovery of multiple hematopoietic cell lines.</p> <p><i>Susceptibility to Infectious Agents and Efficacious Therapy:</i> Research continues to assess susceptibility and resistance to infectious agents in conjunction with use of prompt and chronic sublethal irradiation, and to develop combined modality therapies that attack microorganisms and enhance innate immune response in irradiated personnel. A significant reduction in mortality was shown in animal models using a clinical support protocol based on antibiotic and platelet transfusion regimens.</p> <p style="text-align: center;">DIAGNOSTIC TECHNIQUES</p> <p><i>Biodosimetry and Dose Assessment:</i> No dose-assessment method other than individual physical dosimeters is currently available to deployed soldiers. Automated chromosome dicentric analysis was developed and could be made deployable to the Echelon 3 medical care level. More rapid analytical methods and new biological markers are being evaluated.</p> <p style="text-align: center;">CHEMICAL AND BIOLOGICAL WARFARE CONSEQUENCES WITH RADIATION</p> <p><i>Increased lethality of biological weapons after low level irradiation:</i> Ongoing studies indicate even low sublethal levels of radiation will markedly increase susceptibility to infection by agents of biological warfare. Existing data suggest synergistic consequences of mustard and nerve agents under combined exposure with ionizing radiation.</p>
--

Significant progress has been made in prophylactic and therapeutic measures that will reduce mortality and morbidity in high-dose radiation environments. During the Cold War, the number of casualties resulting from the large-scale deployment of nuclear weapons would have easily overwhelmed the medical assets of NATO forces. In the current threat environment, adequate planning for medical response to a very limited nuclear attack is mandatory. While casualty numbers from a nuclear detonation will still be large, countermeasures have been developed that will significantly limit the morbidity and the secondary mortality. These modalities will be particularly important in the likely scenario of terrorist use of radiation weapons. If the attack is limited to one or, at worst, a small number of events, the ability to provide intensive, sophisticated medical and other support is highly credible because of the availability of uncompromised treatment/research centers and medical evacuation capabilities.

Details of the radiological threats and countermeasures, as well as nuclear defense research and development technical barriers and accomplishments, are presented in Annex D (Section D.3).

3.5 MEDICAL NBC RESEARCH PROJECTION

Table 3-6 presents a projection of the medical NBC defense programs and modernization strategy for the next 15 years.

Table 3-6. Medical NBC Defense Programs and Modernization Strategy

	NEAR (FY00-01)	MID (FY02-05)	FAR (FY06-16)
Medical Chemical Defense	Licensed topical skin protectant	Licensed advanced anticonvulsant Licensed multichambered autoinjector	Licensed reactive topical skin protectant Licensed advanced prophylaxis for chemical warfare agents Licensed specific protection and treatment for blister agents (vesicant agent countermeasures) Licensed ophthalmic ointment for vesicant injury Licensed therapeutic lotion for burns caused by vesicant agents Licensed vesicant agent prophylaxis
Medical Biological Defense	Anthrax vaccine amendment for new dosing schedule	Licensed Q fever vaccine Licensed smallpox (vaccinia virus, cell culture-derived) vaccine	Licensed Next Generation Anthrax vaccine Licensed new plague vaccine Licensed new Venezuelan Equine Encephalomyelitis (VEE) vaccine Licensed multivalent equine encephalitis (VEE/WEE/EEE) vaccine Multiagent vaccine delivery system Portable Common Diagnostic System Licensed multivalent (A,B,C,E, and F) Botulinum vaccine Licensed Ricin vaccine Licensed tularemia vaccine Licensed Brucellosis vaccine Licensed multivalent Staphylococcal enterotoxin vaccine
Medical Nuclear Defense	Broad spectrum, nontoxic androstene steroid protectant validated Combination cytokine therapy validated Risk assessment for low dose, low dose- rate radiation effect Biodosimetry assessment tool software program	Slow-release subcutaneous implants for sustained delivery of radioprotectants New-generation prophylactic and therapeutic immunomodulators for multiorgan injuries Computer models to understand effects resulting from combined NBC attacks Echelon 3 biodosimetry system	Licensed radiation-induced cancer/mutation preventive techniques Licensed countermeasure for chem-bio-radiation interaction Echelon 2 biodosimetry system

3.6 MEDICAL REQUIREMENTS ASSESSMENT

ISSUE: DoD does not have a current approved mechanism for licensure of chemical and biological defense medical products (i.e., drugs and vaccines) because legal and ethical constraints prevent adequate full testing in humans.

SOLUTION: The FDA and DoD are working together to amend the Code of Federal Regulations to allow animal efficacy data to be used in lieu of large-scale human clinical efficacy trials. This mechanism of licensure is vital to provide military service personnel with licensed products. This rule will also establish requirements for licensure and allow the DoD to plan and conduct the appropriate studies to obtain product approval for the products planned for production and licensing. Requests for approval of each medical product will be reviewed on an individual basis. In some cases, human efficacy may be determined to some degree (e.g., the Topical Skin Protectant was tested against poison ivy extract in humans.) In other cases, human efficacy data will not be available. A proposal for the licensure of Botulinum Pentavalent Toxoid using the guinea pig as a surrogate model in lieu of human testing was accepted by a FDA Advisory Committee. The DoD is completing the clinical testing of Botulinum Pentavalent Toxoid for submission of this data to the FDA.

ISSUE: DoD lacks FDA-licensed vaccines against BW threat agents.

SOLUTION: DoD awarded a prime systems contract to DynPort LLC. This contract establishes a single integrator to develop, license, produce, and maintain a stockpile of BD vaccines for protection against BW agents. DynPort LLC is required to obtain and maintain FDA licensure for all the vaccine products developed and produced under this contract by conducting clinical trials and establishing manufacturing procedures.

The contract was awarded in November 1997 and begins with the development and licensure of three vaccines: Q fever, Tularemia, and Vaccinia, and the storage of the current unlicensed BD vaccine stockpile (IND products). There are options for the development and licensure of ten other BD vaccines, which are programmed for development and licensure by FY10.

ISSUE: Anthrax vaccine issues. Anthrax vaccination currently requires a primary series, six dose regimen spaced out over the course of 18 months, with an annual booster to maintain immunity. The timetable for the vaccination series makes it difficult to complete before deployment of forces or to ensure that mobile forces, once deployed, are administered the proper regimen.

SOLUTION: On 18 May 1998, DoD decided to systematically vaccinate all U.S. military personnel against anthrax. Current plans call for personnel serving in high threat regions to receive vaccinations, which began in summer 1998. As of December 1999, more than 383,000 military personnel have received shots of the anthrax vaccine. Total force vaccination is on schedule to be completed in 2005. This decision is crucial for

developing a strategy to maintain the industrial base capability for vaccine production.

A firm fixed price contract to purchase Anthrax Vaccine Adsorbed for the continued supply of anthrax vaccine was awarded, negotiated, and signed for a two-year period. DoD continues to work with BioPort to meet the more stringent requirements the FDA has imposed on all vaccine manufacturers. DoD has provided technical guidance on testing and evaluation and the auditing of quality systems. DoD conducted preliminary testing of a reduction of the dosage regime for Anthrax Vaccine Adsorbed from six vaccinations to five over an 18 month period. The results of this study will be presented to the FDA in FY2000. For more information on the DoD anthrax vaccine program, visit "Concerning the Anthrax Threat" on the Internet at <http://www.anthrax.osd.mil/>.

ISSUE: There is no currently licensed manufacturer for the smallpox vaccine.

SOLUTION: The United States retains approximately 10 million doses of the existing licensed vaccine. USAMRIID is conducting research for the development of antiviral drugs for the treatment of smallpox. Additionally, DoD has filed an investigational new drug (IND) application with the Food and Drug Administration to ensure continued availability of the Vaccinia Immune Globulin (VIG). This product is necessary for treatment of rare adverse events that may occur after smallpox immunization. Also, research is continuing on the development of DNA and replicon vaccines as well as therapeutics, such as monoclonal antibodies, to replace VIG.

ISSUE: The effects on humans resulting from the exposure to low doses of chemical agents, particularly organophosphate (nerve) agents, are not clearly understood.

SOLUTION: Beginning in FY96, DoD, in association with the Research Working Group of the Interagency Persian Gulf Veterans' Coordinating Board, dedicated \$5 million to evaluate the chronic effects of low-dose level exposure to chemical agents. Studies are underway since 1QFY97 to develop highly specific and sensitive assays, preferably forward-deployable, to detect and potentially quantify low-level exposure to chemical agents. These ongoing studies may also identify any long-lasting and toxic metabolites of chemical agents that could account for delayed and long-term health consequences. In addition, studies to look at the impact of possible genetic polymorphisms of cholinesterase enzymes upon individual response to nerve agents are underway. Additional funds have been committed and contracts are being awarded to evaluate potential chronic health complaints resulting from exposure to nerve agents. These contracts were begun 1QFY98. In May 1999, the Department of Defense submitted a report to Congress entitled *DoD Strategy to Address Low-Level Exposures to Chemical Warfare Agents (CWAs)*. This report provided a review of the policies and doctrines of the Department of Defense on chemical warfare defense. Based on this review, DoD recommended no modifications to policies and doctrine, and that existing efforts were well designed to address the need, based on current scientific information.

ISSUE: Radiation exposures below a level that cause acute effects predispose military personnel to injury from other battlefield agents. The magnitude of this interaction has not been fully evaluated.

SOLUTION: Preliminary studies show that a sublethal dose of radiation causes 100% mortality when given to an animal exposed to a 40%-lethal dose of *B. anthracis* spores (anthrax). Furthermore, sublethal doses of radiation can abrogate by approximately 20% protective immunity against anthrax in vaccinated animals. Data is being developed in animal models across the spectrum of combined doses and *B. anthracis*, Venezuelan equine encephalitis virus or blistering agents that can be expected under operational scenarios. The data is subjected to standardized algorithmic analysis in order to extrapolate the consequences of combined exposures in humans and to build casualty prediction models.

ISSUE: The toxic characteristics of the novel threat agents (NTAs) are similar to the conventional nerve agents, and therefore, these NTAs are recognized as a potential threat to the safety of our warfighters. However, current medical countermeasures do not provide the same high level of protection against the NTAs as they do against the conventional nerve agents.

SOLUTION: Develop prophylactics, pretreatment, or therapeutics for the NTAs to reduce the likelihood that our adversaries will employ these agents. Basic pharmacokinetic characteristics such as absorption, distribution, metabolism, and excretion of these agents are necessary to determine the differences in the mechanism of action of the novel agents and the conventional nerve agents in order to develop effective countermeasures.

ISSUE: Victims of a nerve agent attack may suffer silent seizures, i.e., without behavioral manifestations. In a battlefield scenario a medic may not know whether an unconscious victim should be given an anticonvulsant. Left untreated, prolonged seizure activity can produce irreversible neuronal damage and death.

SOLUTION: Develop a miniaturized hand held EEG system for use on the battlefield to detect seizure activity in unconscious victims.

ISSUE: Nerve agents are a significant battlefield threat to the warfighter. Presently fielded antidotes are efficacious if administered promptly. However, some exposure victims may go into prolonged status epilepticus (SE) before being discovered and treated with antidotes. Prolonged untreated SE will lead to development of irreversible neuronal damage, severe incapacitation, and death.

SOLUTION: Develop neuroprotective treatment that will prevent or significantly reduce seizure-induced neuronal damage when administered one or more hours after seizure onset.

Chapter 4

Nuclear, Biological, and Chemical (NBC) Defense Logistics Status

4.1 INTRODUCTION

The overall logistical readiness of the Department of Defense's NBC defense equipment continues to improve. The Services have increased stock of most NBC defense equipment, and the overall Service requirements have decreased as a result of a smaller force. Both factors have improved the overall DoD readiness and sustainment status. Asset visibility initiatives continue to increase the ability to manage what is becoming an increasingly joint collection of NBC defense end items and consumables. A number of items continue to pose a moderate to high risk challenge due to low inventories and continued modernization efforts.

The DoD Chemical and Biological Defense Program jointly manages the research, development, and procurement of major end items of NBC defense equipment. These items are funded through defense-wide funding accounts. Consumable NBC defense items are managed by the Services and the Defense Logistics Agency (DLA) in accordance with Title X responsibilities of the Services and their desires to manage their own operations and maintenance funds. Under the provisions of Title X of the FY95 Defense Authorization Act, Service Secretaries are responsible for, and have the authority to conduct, all affairs of their respective departments including supplying, researching, developing, training, and maintaining equipment. The existence of defense-wide (rather than Service-specific) funding accounts has ensured the joint integration of NBC defense programs. However, no defense-wide (that is, joint) funding mechanism exists for the NBC defense logistics area. Because of this, the *joint* NBC defense community is limited to tracking the status of the DoD NBC defense logistics readiness and sustainment program and making recommendations to correct funding shortfalls.

The Joint Service Materiel Group (JSMG) coordinates NBC defense logistics issues. The JSMG, established by the Joint Service Agreement (JSA), works to ensure a smooth transition through the phases of NBC defense equipment life cycles. It is also charged with developing and maintaining an annual Joint Service NBC Defense Logistics Support Plan (LSP). This LSP forms the basis for the analysis found later in this chapter.

During the past year, increased focus by all Services and DLA on NBC defense logistics has visibly improved the overall program. Estimates are that the risk posed by weapons of mass destruction to early deploying units and special operations forces has been considerably reduced. Readiness shortfalls have been identified and addressed to the degree that full sustainment through a one Major Theater War (MTW) scenario is reasonably assured. The ability to sustain a second nearly simultaneous MTW scenario is not fully assured, due to current and potential critical shortfalls of specific program areas. The Services are programming funds for the FY02-07 POM to specifically address these problem areas. Additionally, the services are formulating

doctrine, tactics, techniques, and procedures for domestic response to terrorist incidents involving weapons of mass destruction. An increasing emphasis on humanitarian and peacekeeping missions worldwide is an additional drain on NBC defense supplies and has added to planning factors.

The Joint Chemical Defense Equipment Consumption Rates (JCHEMRATES) IV study was completed in November 1998. It was staffed to the Services in January 1999 and was validated and approved by the Services in March 1999. This study was sponsored by the Joint Services Coordination Committee and executed through the U.S. Army Center for Army Analysis (CAA). The goal of the JCHEMRATES study is to define the parameters of future chemical warfare scenarios and determine the consumption rates for consumable DoD chemical defense equipment. Using the current Defense Planning Guidance and Quadrennial Defense Report, the JCHEMRATES study developed consumption rates for the two MTW scenarios. These consumption rates include both medical and non-medical chemical defense items for each Service and overall DoD roll-ups for both scenarios. They include both initial issue of chemical defense equipment and sustainment through the 120-day period. These rates form an important basis for determining future Service purchases and their readiness to go to war. The final report on the JCHEMRATES study was published in April 1999.

The JCHEMRATES IV study's two MTW requirement is not and should not be considered a procurement target. This study did not fully consider certain factors such as air transport into theaters of conflict or Navy fleet requirements for ships at sea. While the Services agree with the methodology and intent of the study, the study may require further refinement prior to becoming a fully accepted planning tool. The MTW requirement does not consider peacetime training requirements, sizing requirements, full procurement to the entire active and Reserve forces, or the increasing number of peacekeeping missions in recent years. Thus, the MTW requirement denotes a *minimum planning number*, which if the total DoD inventory drops below, may represent a critical shortfall for that particular item which should be immediately addressed to avoid diminishing the force's NBC defense capability. Because of this limitation in the study, the Services have identified their total Service requirements as their procurement targets, while acknowledging JCHEMRATES as a necessary step in joint service management of the NBC defense program.

The Services continue to have issues regarding the accountability and management of NBC defense item inventories. Limited asset visibility of consumable NBC defense items below the wholesale level remains a problem due to the lack of automated tracking systems at that level (the exceptions being the Air Force and a nascent Marine Corps initiative). This has the full attention of the senior NBC defense managers. The Total Asset Visibility (TAV) project is progressing toward addressing these problems in the long term, but is initially hampered by the uneven quality of inventory reporting.

The Services still procure consumable NBC defense items through multiple, separate, and distinct funding authorizations, as discussed in Section 4.6 of this chapter. Each Service is addressing secondary item procurement policies independently. However, there continue to be

shortfalls of specific NBC defense items when measured against DoD requirements of a two MTW scenario.

The process by which the Services and DLA fund and store war reserve materiel has been hampered by differing definitions, different deployment strategies, and a lack of validated requirements for jointly managed items. The Joint Service Integration Group (JSIG) may be tasked in calendar year 2000 to study Service concerns with JCHEMRATES IV. Once those concerns are addressed, JCHEMRATES will create a solid foundation for providing a basis for the common planning of future requirements.

The JSMG initiated its fourth Joint Service NBC Defense Logistics Support Plan (LSP) in August 1999. This report focuses on identifying the current on-hand stores of the Services' and DLA's NBC defense equipment, and matching these numbers against the requirements generated from the recently completed final JCHEMRATES IV study. The LSP's aim is to identify the Services' readiness and sustainment capability, maintenance requirements, and industrial base issues in the area of NBC defense. The data call conducted for the FY00 LSP was used to develop the findings in this chapter.

4.2 NBC DEFENSE LOGISTICS MANAGEMENT

NBC defense logistics management remains in transition. The Joint NBC Defense Board has begun to exercise full authority in this area, and the JSMG, which reports to the Joint NBC Defense Board, has been charged with coordinating and integrating logistics readiness. The JSMG's role is to identify current readiness and sustainment quantities in the DoD NBC logistics area, with respect to the two MTW scenario outlined in the Quadrennial Defense Review. Developmental NBC defense programs that will be fielded within the POM time period are addressed to identify modernization efforts that are underway.

As currently envisioned, all Services retain "starter stocks" of NBC defense equipment that will support immediate deployments and initial operations. The length of time that these stocks will last each unit depends on the respective parent Service. Air Force units deploy with 30 days of NBC defense consumables. Army divisions use a planning figure of 45 days, while Marine Corps forces and Navy shore units use 60 days as the basis for their plans. As a matter of policy, Navy ships stock 90 days of consumable materiel. However, these values are notional in that they are based on peacetime demand and/or projections of wartime demand as contained in pertinent allowance documentation. For NBC defensive materiel, and particularly in the case of individual protective equipment (IPE), the days of supply represent a minimum stockage position based on current investment guidelines for such materiel. In most cases, the Services will first redistribute any available uncommitted assets to provide sustainment before sourcing elsewhere. Once these starter stocks are depleted, the military force turns to the DoD NBC defense item managers for "swing stocks," also known as "sustainment stocks."

DLA and the Army Materiel Command (AMC) are the item managers, or National Inventory Control Points (NICP), for the vast majority of NBC defense items in all four Services. They are responsible for industrial base development, acquisition, and storage of

wholesale peacetime and sustainment wartime stocks. They buy (process procurement actions) and, if requested, store NBC defense materiel (swing stocks) for the Services. However, the Services must provide funding to DLA and AMC for the procurements.

Currently, only Army owned sustainment stocks are stored in DLA and AMC depots, providing limited back-up for deployed forces during a contingency. Because of a lack of visibility of NBC defense items, unclear wartime requirements (given the post-Cold War environment), scarce Operations and Maintenance funds, and low priorities given to NBC defense stocks, the current quantity of DLA and AMC NBC defense war reserves have been reduced and will not support sustainment requirements for the entire DoD force during a full two MTW scenario. These numbers are reflected in the tables of this chapter.

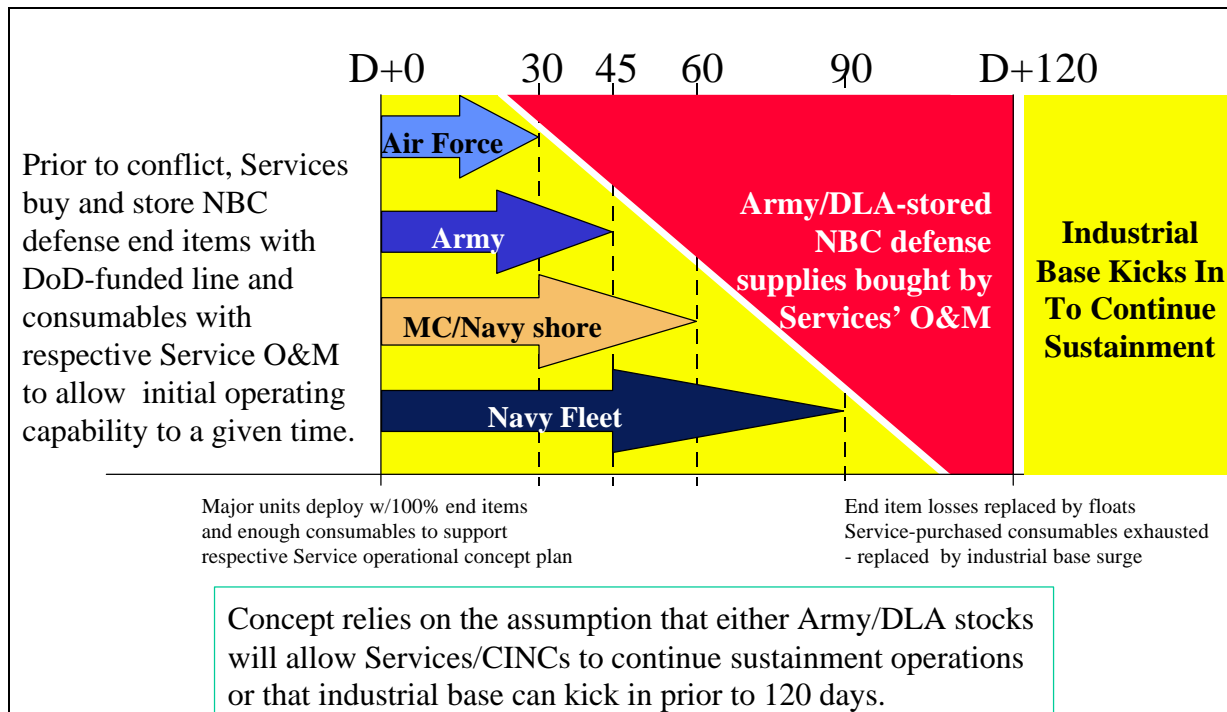

Figure 4-1. War Reserve Requirements and Planning

Service inventories of NBC defense items maintained at unit level use either manual records or a semi-automated tracking system. Stocks held at wholesale level are maintained using a separate automated system. Currently, there is little connectivity between the two systems. As a result, there is limited Service level asset visibility for NBC defense items. The Services are addressing this deficiency under the auspices of TAV, a long-term initiative that will link existing DoD logistics automated systems.

The Army has improved its visibility through an initiative to standardize individual issue of eleven critical NBC defense items across all major commands. Unit Status Reporting was implemented for units to report on-hand stocks vs. requirements on a monthly basis. In addition, plans are in place for consumable chemical defense equipment for all forces other than Force Package I and other early deploying units to be consolidated and centrally stored at Bluegrass

Army Depot. This seven-year execution plan is managed by HQ AMC and will enable better visibility and rotation of NBC defense consumable items. The Air Force has a similar program that consolidates stocks of NBC defense items for deployment in support of contingency operations. These initiatives have also reduced surveillance costs and improved overall management of NBC defense stocks. The Marine Corps has been leading a joint surveillance Technical Working Group, whose initiatives have been increasing cooperative efforts in surveillance and shelf life programs. The Marine Corps has also begun an NBC stocks consolidation program and is developing an NBC Defense Equipment Management Program (DEMP) database to track the inventory, shelf life, and maintenance histories of NBC defense items.

Both DLA and AMC will remain key players in the future NBC defense logistics management system. The Joint NBC Defense Board, through the JSMG, provides coordination and integration based upon the input of all Services and Commanders-in-Chief (CINCs). DLA and AMC will continue to provide services such as raw data collection, inventory control, and a distribution infrastructure. With the results of JCHEMRATES IV, the Services and DLA can immediately begin plans to improve their readiness and sustainment status based on a common understanding of post-Cold War requirements.

4.3 QUANTITIES, CHARACTERISTICS, AND CAPABILITIES

The results of the data collection efforts are compiled in Tables 4-2 through 4-5 in Appendix 1, Logistics Readiness NBC Report Data, located at the end of this chapter. A table is included for each of the four Services and DLA.

The items listed under “Nomenclature” in Tables 4-2 through 4-5 of Appendix 1 are 129 NBC defense items that are currently fielded in the Services. “Total Service Requirements” include the quantity required for the entire Service (to include active and reserve forces), and includes peacetime replacements (wear and tear) and training requirements. Last year, the two MTW requirement quantities were the larger of the initial issue for two MTW or the two MTW consumption computed by the JCHEMRATES IV study (November 1998 data). Those quantities represented the minimum requirements for full sustainment through two conflicts. Recognizing that potentially our forces would be left depleted of resources after the conflicts, the LSP Integrated Product Team (IPT) voted this year to add initial issue quantities to consumption in calculating the two MTW requirement for consumable items. The consumption that is used to compute two MTW requirement provided in Tables 4-2 through 4-5 is based on the final JCHEMRATES IV calculations, dated March 1999.

Note that materiel requirements for training, sizing variations and peacetime replacements are *not* included in the wartime requirements calculated by JCHEMRATES. This number represents an average expenditure calculated among four scenarios: chemical defense equipment expenditures under low chemical weapons use during favorable and marginal weather conditions; and of chemical defense equipment expenditures of high chemical weapons use during favorable and marginal weather conditions. All sets of conditions were run for the North-East Asia and South-West Asia scenarios.

The “Stocks On-Hand” represents the total of all serviceable NBC defense materiel available in each of the Services (stocks positioned with troops, stocks in the supply system and stocks stored in depots/facilities, both peacetime stores and war reserve). This number includes quantities for which a Service or agency has submitted a funded requisition or purchase order in FY99, but has not received the requisitioned items. Finally, the quantities depicted as “Projected Due-Ins” are quantities the Services plan to buy to replace peacetime consumption of NBC defense assets (to include training use and shelf-life expiration), and to buy wartime sustainment stocks. It must be emphasized that these numbers are based on major command estimates of requirements. Actual procurements will be based on available funding.

4.4 LOGISTICS STATUS

During collection of FY99 data, information on the inventory status of 129 fielded NBC defense equipment items was compiled. While radiacs were not traditionally a part of this chapter, they have been retained as an effort towards continuity with other chapters and annexes of this report. NBC defense items such as spare parts and sub-components were considered a subset of the primary item for risk assessments, and were not reviewed separately. Batteries for critical systems are listed for informational purposes. Inventory tracking for batteries is difficult because of a lack of visibility and because they sometimes have other applications. Trainers were not included in the assessment process, since they do not reflect wartime service requirements. Quantities required for wartime needs were then compared to quantities currently on-hand. Characteristics and capabilities of selected fielded NBC defense items are discussed in detail in Annexes A-D of this report.

Although they were in use for part of the year, the M258A1 Decon Kit was dropped from the assessment since their shelf-lives expired during FY99. Among medical consumables, sodium nitrite and sodium thiosulfate are now combined in a single Cyanide Antidote Treatment Kit. The requirements for Pyridostigmine Bromide tablets were adjusted to reflect FDA guidelines which allow them to be administered for only 14 days, rather than 30 days. The Chemical Agent Patient Treatment Medical Equipment Set and Medical Aerosolized Nerve Agent Antidote (MANAA) Atropine Sulfate Inhalation Aerosol were added.

Starting with this report, the two MTW requirement for consumables was adjusted to include the initial issue along with the consumption provided by JCHEMRATES. This decision was made to provide for some inventory to remain after 120 days, thus enhancing our readiness if another conflict ensues. This more closely aligns the requirements calculations with those of other commodities such as ammunition.

Two MTW Requirement for Consumables

Previous definition: equal to the greater of JCHEMRATES Initial Issue **or** Consumption
⇒ No inventory remains after 120 days

New definition: equal to JCHEMRATES Initial Issue **plus** Consumption

⇒ Some inventory remains after 120 days

Readiness for the next conflict is enhanced

Of the 129 items extensively reviewed, DoD developed risk assessments for 50 items based on data gathered as of 30 September 1999 (see Table 4-1). These items were singled out

because of their critical role or their ability to represent the general state of their respective commodity area. While some of the items assessed changed from the previous year's report due to obsolescence, the balance of assessed items among the commodity areas remained as constant as possible to provide for continuity. These items were rated as being in a low, moderate, or high risk category. "Risk" is based on the currently available percent fill of the two MTW requirements; the lower this fill the greater the likelihood that such shortages may significantly reduce DoD's ability to respond to a contingency. Shortages for FY99 were calculated by comparing the two MTW requirements, as defined for this year, to on-hand quantities, as shown in Tables 4-2 through 4-5.

RISK ASSESSMENT

Low –	Services have at least 85 percent of wartime requirement on-hand to support two nearly simultaneous major theater wars
Moderate –	Services have between 70 to 84 percent of wartime requirement on-hand to support two nearly simultaneous major theater wars
High –	Services have less than 70 percent of wartime requirement on-hand to support two nearly simultaneous major theater wars

Table 4-1 provides the results of the assessment. Programs rated as high or moderate risk are discussed in greater detail in Appendix 2. A five-year comparison of data assessments is shown in Figure 4-2. In comparison to FY98 report data, the percentage of the FY99 report's items in the low risk category dropped from 58 percent to 54 percent. The percentage of items in moderate rose from 20 percent to 26 percent, while the percentage of items in the high risk category dropped from 22 percent to 20 percent.

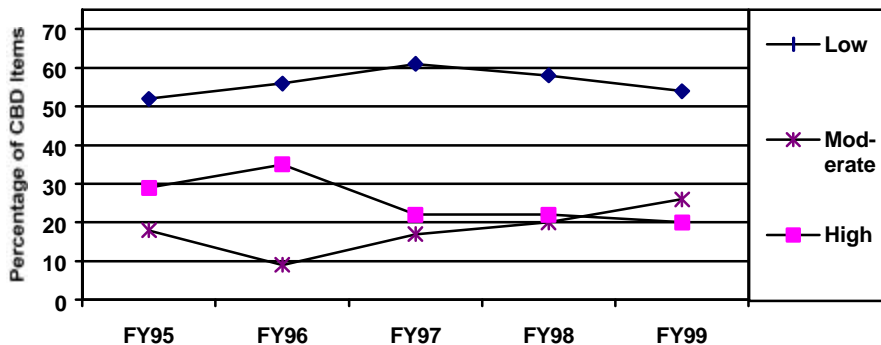

Figure 4-2. Logistic Risk Assessments: 50 NBC Defense Items

The redefinition of the two MTW requirement did not significantly affect most of the items that were assessed. The following items are highlighted:

- The status of M8A1 chemical agent detectors improved due to repairs while its replacement, the M22 ACADA, is being fielded. The Army's assessment and rebuild program returned 1,600 detectors to units, and another 1,500 are being repaired.

- Collectively, 59% of the Marine Corps inventory of CAM/ICAM 1.5 and CAM/ICAM 2.0 are at the Marine Corps Logistics Base needing repair. No funds are yet available for repair, thereby raising their risk.
- Limited quantities of M93A1 NBC Recon Systems continue to constrain early warning chemical reconnaissance and detection capabilities. Continued purchases through FY05 and acquisition of the JSLNBCRS will reduce this risk. Meanwhile, the collective stocks of M93 NBC Recon Systems and M93A1 NBC Recon Systems provide complete fill against the two MTW requirement, also mitigating the risk.
- Quantities of BDOs are not adequate to fill the Air Force requirement. The Air Force developed a mitigation plan in concert with procurement of the JSLIST ensembles to minimize risk. The recent plus-up of procurement funds for protective suits has aided in plans to transition to the JSLIST program. Due to the overall high level of DoD WRM stockage of BDOs, the immediate risk is assessed as low. The BDOs will remain in inventory until they reach maximum shelf life.
- The Air Force is relying on the CWU 66/77P to provide a protective air crew ensemble. It will replace the now obsolete Chemical Protective Undercoverall, and is assessed at moderate risk. Continued planned procurements should correct this assessment in the short term. The Joint Protective Aircrew Ensemble (JPACE), being procured in FY03, will replace this suit.
- The collective protection area continues to be assessed as high risk, in part due to the continued emphasis on contamination avoidance and individual protection, which overshadows this area. As the procurement cycle in these two latter areas matures, the risk assessment of collective protection systems will lessen slightly.
- DS-2 requirements, as determined by JCHEMRATES IV, indicate a significant increase in DS-2 requirements compared to JCHEMRATES III and current on-hand stocks. Because of the magnitude of this change, DS-2 is omitted from the risk assessments pending a detailed review of the JCHEMRATES IV methodology and results.
- With the expiration of M258A1 decontamination kits in FY99, the status of M291 kits becomes more critical. Present inventory and planned procurements should keep this risk low. Production of M295 kits has improved since last year to lessen their risk.
- Medical chemical defense materiel remains generally in low risk. The shortage of Nerve Agent Antidote Kits (NAAK) can be supplemented with existing supplies of atropine and 2-PAM autoinjectors, reducing its risk from moderate to low. These items will gradually be replaced by the Nerve Agent Antidote Treatment Kit beginning about FY04.
- Execution of the Joint Vaccine Acquisition Program (JVAP), combined with adequate stores of vaccine for the major BW threats, resulted in a lowering of the risk category from high to moderate risk. Continued oversight is needed to ensure that the prime systems contractor retains FDA-approved capabilities to develop, license, produce and store vaccines in quantities required to protect the force.

Table 4-1. Logistic Risk Assessments: 50 NBC Defense Items**CONTAMINATION AVOIDANCE/DETECTION EQUIPMENT**

Items	Risk Assessment	Remarks
<i>Radiological</i>		
AN/VDR-2 Radiac Set	Low	USMC is short 22% of requirements
AN/PDR-75 Radiac Set	Moderate	USMC has less than half of requirements (in both above cases, USA quantities offset risk)
AN/UDR-13 Pocket Radiac	High	Low inventory, still fielding
<i>Biological</i>		
Biological Integrated Detection System (BIDS)	Moderate	Low inventory, still fielding
<i>Chemical</i>		
M256A1 Chemical Agent Detector Kit	Low	Shelf life expiration may reduce stocks in future, but has been extended from five to six years
M8 Detection Paper	Low	
M8A1 Automatic Chemical Agent Alarm	Low	Being replaced by M22 ACADA
M1 Chemical Agent Monitor (CAM)/Improved CAM	High	Low inventory; 59% USMC stock needs repair
Chemical Agent Point Detection System (CAPDS)	Low	
AN/KAS-1 Chemical Warfare Directional Detector	Low	
M21 Remote Sensing Chemical Agent Alarm (RSCAAL)	Low	
M22 Automatic Chemical Agent Detector/Alarm	High	Low inventory; still fielding
M93A1 NBC Reconnaissance System "Fox"	Moderate	Low inventory; still fielding; M93 available
Automatic Liquid Agent Detector (ALAD)	Moderate	Low inventory
M272A1 Water Testing Kit	Low	
M274 NBC Marking Set	Low	

INDIVIDUAL PROTECTION

Items	Risk Assessment	Remarks
<i>Masks</i>		
MCU-2/P-series Mask	Low	USAF/USN mask
M40-series General Purpose Mask	Low	USA/USMC mask
M42-series Tank Mask	Low	
M48 Apache Mask	High	Replaces M43-series mask
MBU-19/9 Aircrew Eye/Resp. Protection (AERP)	Moderate	Replaces MBU-13/P; still fielding
<i>Suits</i>		
JSLIST protective suits	Moderate	In process of fielding to all Services
Battle Dress Overgarment (BDO)	Low	No further production – being replaced by JSLIST
Saratoga Suit	Low	No further production – being replaced by JSLIST
CWU 66/77P	Moderate	Low inventory
Chemical Protective Undercoverall	Low	No further production - replaced by CWU 66/77P
Mark III Suit, Collective Protection, Overgarment	Moderate	No further production – being replaced by JSLIST
Aircrewman Cape	Moderate	
<i>Gloves/Overboots</i>		
Chemical Protective Gloves (7/14/25-mil)	Low	
Green/Black Vinyl Overshoes (GVO/BVO)	Low	Risk lowered due to chemical protective footwear cover stocks
Chemical Protective Footwear Covers	Low	
Disposable Chemical Protective Footwear Covers	Low	Replaced by GVO/BVO

Note - Only selected Low Risk programs are displayed for information purposes.

Table 4-1. Logistic Risk Assessments: 50 NBC Defense Items (continued)

COLLECTIVE PROTECTION

Items	Risk Assessment	Remarks
Chemical and Biological Protective Shelter (CBPS)	High	Low inventory, still fielding
M20A1 Simplified Collective Protective Equipment (SCPE)	High	Low inventory, not in production
M28 CPE HUB	High	Low inventory, still in production
M48A1 General Purpose Filter	Moderate	Low inventory
Filter For (M59, M56, Shipboard) (200 CFM)	Low	

DECONTAMINATION EQUIPMENT

Items	Risk Assessment	Remarks
M291 Skin Decontaminating Kit	Low	Quantities cover loss of M258A1
M295 Individual Equipment Decontamination Kit	Low	
DS-2, M13 Can	High	Low inventory
M11 Decontaminating Apparatus	Low	
M13 Decontaminating Apparatus, Portable	High	Low inventory
M17-series Lightweight Decontamination System (LDS) (to include the A/E32U-8 Decontamination System)	Moderate	Low inventory reported
M12A1 Power Driven Decontamination Apparatus (PDDA)	Low	

MEDICAL DEFENSE

Items	Risk Assessment	Remarks
Mark 1 Nerve Agent Antidote Kit (NAAK)	Low	Risk lowered based on autoinjector stocks
Atropine Autoinjector	Low	
2-PAM Chloride Autoinjector	Low	
Nerve Agent Preventative Pyridostigmine (NAPP) Tablet	High	Due to new 2 MTW requirement
Convulsant Antidote Nerve Agent (CANA) Autoinjector	Moderate	Due to new 2 MTW requirement
Biological Warfare Vaccines	Moderate	Prime contract awarded for development, production, FDA licensure, and storage

Note - Only selected Low Risk programs are displayed for information purposes.

Based on the average two MTW requirements identified in the JCHEMRATES IV study as of March 1999, the Services continue to exhibit shortages in certain critical areas. Shortages of chemical and biological agent detection systems, collective protection shelters and their respective filters, and biological warfare vaccines may have a serious impact on the joint force’s ability to survive and sustain combat operations under NBC warfare conditions operating in two nearly simultaneous MTWs. The extent of the operational impact of NBC defense equipment shortages is under review in several classified studies.

4.5 PEACETIME REQUIREMENTS

In peacetime, quantities of NBC defense equipment are necessary to train personnel in NBC defense and to build confidence that NBC equipment will provide the necessary protection when used correctly. The two most critical areas of peacetime stocks are individual protective equipment and medical chemical defense materiel. The Services have indicated that adequate NBC defense equipment is on-hand to conduct training.

Generally, items used in peacetime for training are drawn from wholesale stocks, requiring units to maintain both training and contingency stocks. For selected items, such as

protective clothing, contingency utility is lost when the item is used (or consumed) for training. Because peacetime training requirements are met in this manner, major commands do not track training equipment in their estimates of on-hand requirements.

4.6 FUNDING

In accordance with the NBC defense management initiatives outlined in Chapter 1, funding of RDT&E and procurement was centralized in a DoD defense-wide account beginning in FY96. Operations and maintenance (O&M) funding for NBC defense materiel is not consolidated at the DoD level. Therefore, for non-major (secondary) end items (*e.g.*, consumables such as decontamination kits, detection kits, and filters), each Service continues to separately fund replenishment and sustainment of NBC defense equipment. Depot maintenance and contractor logistics support for some low density major items are also O&M funded. These appropriations are not included in the joint NBC defense program.

Funding of NBC defense items classified as war reserves secondary items (WRSI) remains a significant issue. The Services are responsible for developing the requirements and funding items in war reserve stocks. Funding of WRSI comes from Congressional appropriations made into the Working Capital Fund from the transfer of Services' O&M funds. For example, replenishment of NBC defense items in Army war reserves, such as the M258A1 kits and BDOs, will require substantial funding through 2006 as these items reach their maximum extended shelf lives. Funding will be required to replace the Army and Air Force's current inventories of BDOs with the Joint Service Lightweight Integrated Suit Technology (JSLIST). The Marine Corps, through its normal requirements generation and acquisition process, was able to obtain 100% war reserve of Saratogas for initial projected war reserves requirement (the Marine Corps no longer considers the BDO to be a viable asset). The recent plus-up of funds for protective suits is assisting in building an initial stockage and minimum sustainment (war reserve) stock to meet the current defense planning guidance.

Under current acquisition procedures and DoD guidance to minimize wholesale stock-piles, procurements are based only on funded Service requisitions. The Services remain responsible for program funding to replace NBC defense equipment wartime stocks. Procurement is usually based on economic buy quantities (a consolidation of all Service requisitions) to provide the best value to the government. Some procurements, however, suffer significant delays in delivery because of the time required to accumulate sufficient requisitions to produce economic buy quantities. This situation occurs when item managers try to plan purchases of consumable items that have a low peacetime consumption but high wartime consumption (such as decontamination kits, large collective protection filters and M256A1 detector kits). The result is a low purchasing history with a small industry production capability, which in turn causes a very low war reserve status with minimal industry surge capability. The JCHEMRATES IV study is intended to provide more accurate requirements on which the Services can base their planning.

4.7 INDUSTRIAL BASE

With the end of the Cold War, a smaller DoD force, and subsequently reduced requirements for NBC defense items, lowered purchases of NBC defense consumables continue to threaten the industrial viability of this sector. While the sector is improving, vulnerabilities still exist. Collective protection systems (filters in particular) continue to be the most critical sub-sector in the NBC defense area. Additionally, protective clothing procurement continues to receive intense scrutiny due to the possibility of industrial base shortfalls in satisfying requirements during a contingency. The reluctance of pharmaceutical industries to support DoD CB defense medical programs, coupled with a lack of government vaccine production, represents a serious medical industrial base shortcoming.

These assessments indicate that the NBC defense industrial base sector is primarily supported by small- to medium-sized highly specialized companies dedicated to producing military unique products with little or no commercial utility. These companies have become dependent on Service demands and sales for their financial survival. Selected NBC defense items (BDOs, chemical gloves, and nerve agent autoinjectors) have been designated as critical to combat operations because of low peacetime demand, high wartime use, and the fragile supporting industrial base. As a result, DLA established, with OSD approval, a “War Stopper” program to sustain key industrial base capabilities, utilizing industrial preparedness funding under PE 07080110.

The mission of the Joint Service Integrated Product Team (IPT) for Industrial Base Management and Planning is to assist the Services in identifying problems and issues associated with implementing and executing a Joint Service NBC Defense Industrial Base Management Plan. The IPT will be able to provide DoD decision makers with accurate industrial base information and analyses. It consists of representatives from the JSMG and JSIG, Joint Staff, Office of the Secretary of Defense, logistics representatives and Commodity Area Managers from the four Services and DLA.

The IPT is addressing issues from across the Services for more than 128 items/systems and spare parts critical to readiness. The IPT is conducting analyses to include industrial and technology capabilities, alternative sources of supply, and a financial and economic analysis. These analyses will provide the NBC management structure with alternatives and recommendations within the sub-sectors of NBC defense. To date, all systems were evaluated with 41 systems given in-depth analysis. Industrial preparedness measures were recommended for some of those items with others identified as having a need for re-programming to fund buy-outs that would make up the shortfalls.

4.8 NBC DEFENSE LOGISTICS SUPPORT ASSESSMENT

ISSUE: The Department of Defense's NBC Defense Program has a full capability to support and sustain the first of two MTWs. Readiness shortfalls that would preclude full support of a second MTW have been identified and will be addressed in the next POM (FY02-07). The Services' modernization efforts and common war reserve requirements will lessen the overall risk over the near term.

SOLUTION: The Services continue to increase their readiness and sustainment status by consolidating common stocks and increasing visibility of their wholesale stocks. In most cases, accelerated procurement of critical items into war reserves will increase readiness against the potential use of weapons of mass destruction.

During 1998, all four Services participated in the development of the JCHEMRATES IV study, which was finalized in 1999. JCHEMRATES IV provides a more accurate prediction of the initial issue and sustainment quantities required for each Service. The use of this common methodology will allow the presentation of joint service requirements in future reports and facilitate improved joint logistics management.

ISSUE: DoD continues to lack a joint, integrated system to maintain asset visibility of NBC defense equipment below wholesale level, and lacks a standardized war reserve program for NBC defense equipment. Resourcing the procurement and sustainment of wartime stocks of individual protective equipment, decontamination kits, and detector kits remains the responsibility of the Services.

SOLUTION: DoD established the requirement for asset visibility and reviewed existing systems and procedures, both for peacetime reporting and war time reporting. The Services and DLA are addressing the NBC defense asset visibility deficiency under the auspices of the Total Asset Visibility initiative.

ISSUE: NBC defense industries have a limited ability to augment specific shortfalls during any future contingency, in part due to lowered DoD procurements and the inability to retain warm production lines in critical areas. Without the introduction of significant plus ups or the use of innovative business practices (such as the use of performance specifications), many of the small firms that make up this sector may choose to focus entirely on the commercial market place.

SOLUTION: The Department of Defense continues to pursue innovative strategies to maintain a responsive industrial base, especially those strategies that decrease industry reliance on DoD procurement for industrial base survival. Strategies may include tapping into independent research and development (IR&D) conducted by universities and corporations, increasing reliance on dual-use technologies, and pursuing strategies that will encourage companies to decrease dependency on DoD requirements for their survival.

ISSUE: Equipment assets needing repair reduce inventory. Mechanisms to track maintenance requirements and initiate repairs are needed to reduce this risk.

SOLUTION: In 1984, with the assistance of the U. S. Army Defense Chemical Equipment (DCTE) Division, Pine Bluff Arsenal, the NBC Test and Evaluation Program was established to conduct surveillance testing and evaluation of all Individual Chemical Protective Equipment throughout the Marine Corps. The focus of the program was to ensure the combat readiness of NBC assets held at all levels of supply, from the depots to the using units, while maximizing the service life of assets. A surveillance unit was established at each of the Marine Corps Logistics Bases to perform both mobile and fixed site testing. Testing of overseas assets was accomplished utilizing a mail in program.

During Desert Shield, the two facilities conducted around the clock operations to ensure every Marine deploying to Southwest Asia had a serviceable Field Protective Mask and chemical ensemble. The two Test and Evaluation Units performed tests on over 94,000 masks from field units and warehouse stockpiles during this period.

The program was re-evaluated following Desert Shield/Desert Storm and reorganized to better support the Marine Forces. The Test and Evaluation Units were moved from the Logistics Bases to sites at Camp Lejeune, NC and Camp Pendleton, CA. A new test facility was stood up in Okinawa, Japan to support the high demand for overseas testing. Unmanned sites in Iwakuni, Japan (supported by the Okinawa unit) and Kaneohe Bay, Hawaii (supported by the Camp Pendleton unit) were also established,

In 1997, DoD encouraged the program to support NBC surveillance within all the branches of service. The program's name was changed to the Joint Service Equipment Surveillance Program and the Test and Evaluation Units were renamed as Equipment Surveillance Units.

The program provides surveillance, directed screening services, contracted toxic testing, repair, vacuum packaging, technical support, guidance and training to all services in support of NBC Individual Protective Equipment. Asset surveillance is utilized to detect degradation trends and promote unit readiness. Certified personnel and equipment are used to visually and mechanically test the assets.

The Equipment Surveillance Units perform intermediate level repairs of NBC assets to include M41 PATS and diagnostic checks on CAMs to correct defective assets. These repairs range from parts replacement, patching, eye lens crimping to packaging and repackaging. While on site, these teams provide training in the preventive maintenance and care of assets.

The DCTE Division at Pine Bluff Arsenal is the alternate source for NBC Individual Protective Equipment to support special surveillance efforts beyond the current program's capacity. Future plans are to expand the program to include Navy surveillance

personnel support and providing surveillance services in support of general clothing and equipment.

The program has a far-reaching impact upon NBC readiness throughout the services. It provides critical input into the research, development, testing and evaluation of new NBC equipment. The program is also a key player in the joint service's efforts to standardize NBC policy and procedures.

APPENDIX 1.
**BREAKOUT OF SERVICE WAR REQUIREMENTS, STOCKS ON-HAND,
AND PLANNED ACQUISITIONS**

The following tables display NBC defense equipment total Service requirements, their wartime requirements, stocks on-hand quantities to include FY99 quantities on contract, and FY00–01 planned procurements for each of the four Services and Defense Logistics Agency. As mentioned earlier in this chapter, the two MTW requirements for consumables are based on the sum of the initial issue and the average consumption developed under the JCHEMRATES IV study, updated as of March 1999.

It should be emphasized that the JCHEMRATES IV study's two MTW requirement is not and should not be considered a procurement target. This study did not fully consider air transport into theaters of conflict or Navy fleet requirements for ships at sea. While the Services in general agree with the methodology and intent of the study, it may require further refinement prior to becoming a fully accepted planning tool. The MTW requirement does not consider peacetime training requirements, sizing requirements, or full procurement for the entire active and Reserve forces and critical operational personnel. The MTW requirement does denote a minimum planning number, which if the total DoD inventory drops below, may represent a critical shortfall for that particular item, which should be immediately addressed to avoid diminishing the force's NBC defense capability.

Because of this limitation in the study, the Services have identified their total Service requirements as their procurement targets, while acknowledging JCHEMRATES as a necessary step in joint service management of the NBC defense program. The Services continually update these data call sheets on a frequent basis and consider these working papers rather than a static set of figures. The Services and DLA are working through the FY00 Joint Service NBC Defense Logistics Support Plan to update all figures and to provide 100% of the information required for logistics readiness and sustainment assessments.

Table 4-2a. Army Logistics Readiness Data - Non-Consumables

NOMENCLATURE	NSN	TOTAL SERVICE RQMTS	NO. REQUIRED FOR 2 MTW	STOCKS ON HAND TO INCLUDE FY99 DUE IN	PROJECTED DUE IN					
					FY00	FY01	FY02	FY03	FY04	FY05
INDIVIDUAL PROTECTION COMMODITY AREA										
CB MASK										
MASK, CB, M17A2	4240-01-143-2017-20	218,274	0	234,670	0	0	0	0	0	0
MASK, CB, M40/M40A1	4240-01-258-0061-63	508,832	347,118	605,392	125,117	25,591	0	0	0	0
MASK, M24, AVIATOR	4240-00-776-4384	46,391	0	16,660	0	0	0	0	0	0
MASK, M25A1, TANK	4240-00-994-8750-52	17,642	0	16,277	0	0	0	0	0	0
MASK, M42, TANK	4240-01-258-0064-66	96,249	18,514	95,500	0	0	0	0	0	0
MASK, M43, APACHE	4240-01-208-6966-69	4,553	0	3,284	0	0	0	0	0	0
MASK, M45, AVIATOR	4240-01-414-4034-35/-4051-52	9,500	1,844	237	20,936	94	0	0	0	0
MASK, M48, APACHE	4240-01-386-0198/-4686/-0201/-0207	5,801	330	6	0	0	0	0	0	0
MASK, M49	4240-01-413-4095-99	12,744	1,844	0	0	0	0	0	0	0
MISC PROTECTION										
PATS, M41	4240-01-365-8241	3,334	3,334	3,324	750	589	0	0	0	0
CONTAMINATION AVOIDANCE COMMODITY AREA										
NUCLEAR DETECTION EQUIPMENT										
AN/PDR-75	6665-01-211-4217	6,039	5,445	3,602	0	0	0	0	0	0
AN/PDR-77	6665-01-347-6100	685	532	346	0	0	0	0	0	0
AN/UDR-13	6665-01-407-1237	26,901	26,901	298	0	0	0	0	0	0
AN/VDR-2	6665-01-222-1425	36,974	33,405	29,092	0	0	0	0	0	0
BIOLOGICAL DETECTION EQUIPMENT										
BIDS, M31	6665-01-392-6191	124	124	70	0	0	0	0	0	0
LR-BSDS, M94	6665-00-422-6605	24	24	0	0	0	0	0	0	0
CHEMICAL DETECTION EQUIPMENT										
ACADA, M22	6665-01-438-6963	28,839	28,839	4,497	4,120	0	0	0	0	0
ALARM, CAA, M8A1	6665-01-105-5623	28,000	28,000	18,080	600	800	1,200	800	500	500
CAM/ICAM	6665-01-357-8502	18,817	18,817	6,562	0	0	0	0	0	0
M21 RSCAAL	6665-01-324-6637	123	123	156	0	0	0	0	0	0
NBC RECON SYS, M93A1	6665-01-372-1303	123	123	30	0	0	0	0	0	0
DECONTAMINATION COMMODITY AREA										
DECON APPAR, M11	4230-00-720-1618	37,287	37,287	25,923	0	0	0	0	0	0
DECON APPAR, M13	4230-01-133-4124	226,800	111,125	36,858	0	0	0	0	0	0
DECON APPAR, PDDA, M12A1	4230-00-926-9488	682	129	459	0	0	0	0	0	0
L/WT DEC SYS, M17A1	4230-01-303-5225	2,516	2,516	1,035	0	0	0	0	0	0
COLLECTIVE PROTECTION COMMODITY AREA										
CP DEPMEDS (HUB, CP, M28)	4240-01-395-5179	23	23	4	8	0	0	0	0	0
SHELTER, CB PROTECT	5410-01-441-8054	572	572	88	37	31	26	38	37	45
SHELTER, CP, M20/M20A1	4240-01-166-2254	2,019	1,747		0	0	0	0	0	0
SHELTER, M51	4240-00-854-4144	0	0		0	0	0	0	0	0
MEDICAL COMMODITY AREA										
LITTER, DECONTAMINABLE	6530-01-380-7309	5,148	5,148	6,026	1,052	0	0	0	0	0

Table 4-2b. Army Logistics Readiness Data – Consumables

NOMENCLATURE	NSN	TOTAL SERVICE RQMTS	NO. REQUIRED FOR 2 MTW	STOCKS ON HAND TO INCLUDE FY99 DUE IN	PROJECTED DUE IN	
					FY00	FY01
INDIVIDUAL PROTECTION COMMODITY AREA						
OVERGARMENTS						
CHEM PROT UNDERGARMENT TOP	8415-01-363-8692-00	728,718	0		0	0
CPU DRAWERS	8415-01-363-8683-91	728,718	431,564	133,891	0	0
JSLIST (ABDO) 45 DAYS	SEE NSNs IN TABLE 4-6	2,346,809	2,236,736	85,248	169,464	163,928
SCALP (TAN AND GREEN)	8415-01-333-0987-89		0		0	0
	8415-01-364-3320-22	151,475	151,475	236,568	0	0
SUIT, CP CAMO (BDOs)	8415-01-137-1700-07	0	0	2,933,083	0	0
OVERBOOTS/GLOVES						
BLK/GRN VINYL O/BOOTS	8430-01-317-3374-85		0	1,522,534	0	0
	8430-01-049-0878-87	7,412,697	2,899,864	103,228	0	0
CPO FOOT COVERS	8430-01-021-5978	1,028,707	0	135,588	0	0
CP GLOVES 7 MIL	8415-01-138-2501-04	473,041	154,612	112,074	0	0
CP GLOVES 14 MIL	8415-01-138-2497-00	1,067,558	618,448	239,991	0	0
CP GLOVES 25 MIL	8415-01-033-3517-20	6,270,220	3,861,320	4,554,178	0	0
MISC PROTECTION						
2D SKIN, M40 SERIES	4240-01-413-1540-43	812,709	691,040	126,275	80,979	43,500
BATTERY, BA-5800 (PRO MASK)	6665-99-760-9742	61,052	61,052	246	0	0
CP HELMET COVER	8415-01-111-9028	1,605,279	1,605,279	3,083,428	0	0
FILTER CAN, C2A1	4240-01-361-1319	1,764,884	1,367,626	753,629	358,000	264,000
FILTER CAN, M10A1	4240-00-127-7186	196,464	0	52,118	0	0
FILTER ELEMENT, M13A2	4240-00-165-5026	584,511	0	203,876	0	0
HOOD, M40	4240-01-376-3152	3,534,562	1,703,570	1,145,841	334,500	204,000
HOOD, M5 (FOR M25A1)	4240-00-860-8987	46,316	0	24,788	0	0
HOOD, M6A2 (FOR M17)	4240-00-999-0420	733,910	0	50,825	0	0
HOOD, M7 (FOR M24)	4240-00-021-8695	44,172	0	119,221	0	0
CONTAMINATION AVOIDANCE COMMODITY AREA						
CHEMICAL DETECTION EQUIPMENT						
BATTERY, ACADA BA-5590	6135-01-036-3495	55,000	110,000	328,199	0	0
BATTERY, BA-3517	6135-00-450-3528	151,141	52,645	18,992	0	0
BATTERY, ICAM BA-5800	6665-99-760-9742	52,645	52,645	8,948	0	0
Battery, M42 BA3030	6135-00-930-0030	220,000	440,000			
DET KIT, M256A1	6665-01-133-4964	198,290	48,027	62,805	0	0
DET PAPER, M8	6665-00-050-8529	2,169,231	2,169,231	1,929,991	58,374	0
DET PAPER, M9	6665-01-226-5589	2,023,873	2,023,873	820,332	0	0
MAINT KITS, M293/M273	5180-01-379-6409	80,223	0	0	0	0
	5180-01-108-1729	41,106	41,106	22,225	0	0
NBC MARK SET, M274	9905-12-124-5955	38,733	9,906	38,641	15,229	0
WATER TEST KIT, M272A1	6665-01-134-0885	9,580	9,580	9,028	7,050	0
DECONTAMINATION COMMODITY AREA						
DECON KIT, M258A1	4230-01-101-3984	834,253	0	112,436	0	0
DECON KIT, M291	6850-01-276-1905	1,147,688	183,382	170,453	5,422	0
DECON KIT, M295	6850-01-357-8456	752,595	166,892	90,055	0	0
DS2, 1 1/3 QT	6850-00-753-4827	700,344	700,344	195,955	17,499	0
DS2, 5 GAL	6850-00-753-4870	4,865,259	4,865,259	248,288	0	0

Table 4-2b. Army Logistics Readiness Data - Consumables

NOMENCLATURE	NSN	TOTAL SERVICE RQMTS	NO. REQUIRED FOR 2 MTW	STOCKS ON HAND TO INCLUDE FY99 DUE IN	PROJECTED DUE IN	
					FY00	FY01
DS2, M13 CAN	6850-01-136-8888	2,193,465	2,193,465	108,035	0	0
NITROGEN CYLINDERS	4230-00-775-7541	1,319,022	1,319,022	39,121	0	0
STB, 50 LB	6850-00-297-6653	10,628	10,628	19,049	0	0
COLLECTIVE PROTECTION COMMODITY AREA						
FILTER, CP, M12A2 (M14 GPFU)	4240-01-365-0981	12,816	12,816	4,364	463	0
FILTER, CP, M13 SERIES (M14 GPFU)	4240-00-368-6291	12,816	12,816	3,232	1,546	0
FILTER, CP, M18A1	4240-01-365-0982	60,580	60,580	18,290	1,036	0
FILTER, CP, M19	4240-00-866-1825	44,971	44,971	10,002	270	0
FILTER, GP, M48A1	4240-01-363-1311	15,930	15,930	11,384	8,262	0
FILTER SET FOR (M59, M56, SHIPBOARD)	4240-01-369-6533	1,167	1,167	4,775	6,836	4,314
MEDICAL COMMODITY AREA						
2-PAM CHLORIDE AUTOINJ	6505-01-125-3248	1,349,637	1,349,637	1,260,789	0	0
ATROPINE AUTOINJ	6505-00-926-9083	1,874,828	1,874,828	561,732	0	0
CANA AUTOINJ	6505-01-274-0951	1,554,920	1,554,920	558,686	185,187	185,187
MED AEROS NERVE AG ANT (MANAA)	6505-01-332-1281	2,238		3,987		
NAAK, MKI	6705-01-174-9919	2,281,312	2,281,312	923,410	222,189	0
PYRIDOSTIGIMINE TAB	6505-01-178-7903	1,317,309	1,317,309	421,470	11,886	11,886
PATIENT WRAPS	6530-01-383-6260	18,900	18,900	9,175		
MES, CHEM AG PAT DECON	6545-01-176-4612	1,575	1,575	394	104	0
MES, CHEM AG PAT TREATMENT	6545-01-141-9469	2,238		468	205	0
OTHER TREATMENTS						
CIPROFLOXACIN	6505-01-272-2385		0	42,270	0	0
	6505-01-273-8650		0	27,622		
	6505-01-333-4154	1,881,870	1,881,870	398	0	0
DOXYCYCLINE CAPS	6505-01-153-4335		0	102	0	0
ANTIDOTE TREATMENT KIT, CYANIDE	6505-01-143-4641	67,140	67,140	419	0	0
	6505-01-457-8901	22,380	22,380	1,295	785	0

Table 4-3a. Air Force Readiness Data – Non-Consumables

NOMENCLATURE	NSN	TOTAL SERVICE RQMTS	NO. REQUIRED FOR 2 MTW	STOCKS ON HAND TO INCLUDE FY99 DUE IN	PROJECTED DUE IN					
					FY00	FY01	FY02	FY03	FY04	FY05
INDIVIDUAL PROTECTION COMMODITY AREA										
CB MASK										
MASK, A/P22P2	NOT ASSIGNED	14,810	14,810							
MASK, AERP	8475-01-339-9782(S)	34,833	34,833	4,720	0	353	163	12	10	13
MASK, CB, M17A2	4240-01-143-2017-20	5,132	5,132	1,577	10	2	0	0	0	0
MASK, MCU-2/P,	4240-01-415-4239-41	445,112	106,382	65,328	123	2,209	787	120	120	120
MASK, MCU-2A/P	4240-01-284-3615-17	106,382		16,144	5,244	1,100	25	25	50	0
MASK, MCU-2A/P (WR) USAF	4240-01-327-3299-01	39,978		92,795	0	200	50	85	50	50
MISC PROTECTION										
PATS, M41	4240-01-365-8241	1,500	1,160	16	0	0	1	0	0	0
CONTAMINATION AVOIDANCE COMMODITY AREA										
NUCLEAR DETECTION EQUIPMENT										
ADM 300 - A KIT	6665-01-363-6213NW	300	117	97	0	0	0	0	0	0
- B KIT	6665-01-342-7747NW	800	597	189	0	0	0	0	0	0
- C KIT	6665-01-320-4712NW	750	518	246	0	3	0	0	0	0
- E KIT	6665-01-426-5071NW	250	119	86	0	3	1	1	1	1
CHEMICAL DETECTION EQUIPMENT										
ACADA, M22	6665-01-438-6963	2,140	2,140	1,224	0	0	9	0	0	0
ALARM, CAA, M8A1	6665-01-105-5623	423	331	127	1	5	0	0	0	0
CAM/ICAM	6665-01-357-8502	125	108	54	0	14	0	0	0	0
	6665-01-199-4153	1,960	1,960	83	0	17	2	0	0	0
M90 CHEM WARFARE ALARM	6665-01-408-5108	65	58	15	0	18	0	0	0	0
DECONTAMINATION COMMODITY AREA										
A/E32U-8 DECON SYS	4230-01-153-8660	175	0	22	0	1	0	0	0	0
L/WT DEC SYS, M17	4230-01-251-8702	299	0	72	0	3	0	0	0	0
L/WT DEC SYS, M17A1	4230-01-303-5225	50	0	21	0	0	0	0	0	0
L/WT DEC SYS, M17A2	4230-01-349-1778	157	157	20	0	0	0	1	0	0
COLLECTIVE PROTECTION COMMODITY AREA										
KMU-450 SHEL MOD KIT	4240-01-044-7659	25	16	1	0	0	0	0	0	0
CHATH (HUB, CPE, M28)	NOT ASSIGNED	* 21	20	8	* 10	0	0	0	0	0
MEDICAL COMMODITY AREA										
LITTER, DECONTAMINABLE	6530-01-380-7309	26,770	26,770	8,110	0	0	0	0	0	0

* CHATH fielding currently being reevaluated by Air Force Medical Service

Table 4-3b. Air Force Logistics Readiness Data - Consumables

NOMENCLATURE	NSN	TOTAL SERVICE RQMTS	NO. REQUIRED FOR 2 MTW	STOCKS ON HAND TO INCLUDE FY99 DUE IN	PROJECTED DUE IN	
					FY00	FY01
INDIVIDUAL PROTECTION COMMODITY AREA						
OVERGARMENTS						
AIRCREWMAN CAPE	8415-01-040-9018	290,014	283,502	101,327	432	1,232
CLOTHING TEST KIT	6630-00-783-8192	200	167	370	0	260
CP UNDERCOVERALL	8415-01-040-3136-44	75,000	67,376	19,265	8,070	30
EOD HGU-65P HOOD	4240-01-338-1646	225	192	604	0	30
EOD M-3 TAP	8415-00-099-6962/68/70	312	176	4	0	30
	8415-01-105-2535		0			
EOD TAP BOOTCOVER	8430-00-820-6295-6306	275	199	26	0	60
EOD TAP GLOVES	8415-00-753-6550-54	500	375	54	0	60
IMPREG UNDERGARMENT	8415-00-782-3242-5	5,000	5,000	1,406	0	79
JSLIST (ABDO) 45 DAYS	SEE PROGRAM SHEET	1,100,000	705,362	7,584	0	9,099
M-2 APRON	8415-00-281-7813-16	225	198	144	0	1
M3 COOLING HOOD	8415-00-261-6443	350	308	0	0	1
M3 COOLING SUIT	8415-00-264-2929	200	170	0	0	1
SUIT, AIRCREW, CWU-66/77P	8475-01-328-3434-57	150,000	74,871	37,089	3,206	2,180
SUIT, CP CAMO (BDO)	8415-01-137-1700-07	801,167	801,167	500,997	2,695	10,209
SUIT, CP CAMO-DESERT 3 clr	8415-00-327-5347-53	13,878	13,878	36,474	40	643
SUIT, CP CAMO-DESERT 6 clr	8415-01-324-3084-91	23,656	23,656	11,934	0	30
OVERBOOTS/GLOVES						
BLK/GRN VINYL O/BOOTS BVO GVO	8430-01-317-3374-85	1,006,127	0	535,713	1,427	8,697
	8430-01-049-0878-87	6,000	992,103	114,646	5,837	1,200
CP FOOTWEAR COVERS	8430-01-118-8172		0			
	8430-01-021-5978	154,802	0	32,326	0	0
CP GLOVES 7 MIL	8415-01-138-2501-04	464,534	464,534	90,822	0	2,218
CP GLOVES 14 MIL	8415-01-138-2497-00	1,834,565	1,257,871	1,177,598	5,168	14,996
CP GLOVES 25 MIL	8415-01-033-3517-20	90,000	23,051	23,825	20	1,428
CP SOCKS	8415-01-040-3169	200,056	170,768	62,301	2,632	2,144
DISP FOOTWEAR COVER	8430-00-580-1205-06	201,980	185,771	175,364	3,279	2,215
GLOVE INSERTS	8415-00-782-2809 (S)	2,245,876	1,688,335	655,543	11,009	8,951
MISC PROTECTION						
FILTER CAN, C2/C2A1	4240-01-119-2315	1,998,925	955,751	929,585	17,052	29,722
FILTER, GP	4240-01-161-3110	2,090	1,750	650	0	100
FILTER ELEMENT, M13A2	4240-00-165-5026	12,596	12,596	14,697	12	280
HOOD, M6A2 (FOR M17)	4240-00-999-0420	95,093	76,707	328,340	36	149
HOOD, MCU-2/P	4240-01-189-9423	2,225,189	700,774	1,032,488	8,345	5,865
CONTAMINATION AVOIDANCE COMMODITY AREA						
CHEMICAL DETECTION EQUIPMENT						
BATTERY, ACADA BA-5590	6135-01-036-3495	46,331	46,331	331	50	130
BATTERY, BA-3517	6135-00-450-3528	880	0	308	0	32
BATTERY, ICAM BA-5800	6665-99-760-9742	67,295	67,295	1,054	0	44
DET KIT, M18A2	6665-00-903-4767	100	0	13,225	117	0
DET KIT, M256A1	6665-01-133-4964	50,123	1,292	1,668	1,668	0
DET PAPER, M8	6665-00-050-8529	454,096	316,274	468,535	468,535	1,732

Table 4-3b. Air Force Logistics Readiness Data – Consumables

NOMENCLATURE	NSN	TOTAL SERVICE RQMTS	NO. REQUIRED FOR 2 MTW	STOCKS ON HAND TO INCLUDE FY99 DUE IN	PROJECTED DUE IN	
					FY00	FY01
DET PAPER, M9	6665-01-049-8982	50,606	0			
	6665-01-226-5589	355,994	355,994	470,099	13,774	11,948
MAINTENANCE KIT, M293	5180-01-379-6409	90	0	120	0	8
NBC MARK SET, M274	9905-12-124-5955	725	517	891	50	10
WATER TEST KIT, M272A1	6665-01-134-0885	764	764	188	25	1
DECONTAMINATION COMMODITY AREA						
CALCIUM HYPOCHLORITE	6810-00-255-0471	625	625	1	0	10
DECON KIT, M258A1	4230-01-101-3984	725,370	0	157,927	0	0
DECON KIT, M291	6850-01-276-1905	225,093	14,423	179,083	0	10,350
DECON KIT, M295	6850-01-357-8456	135,092	7,538	86,701	3,968	10,969
DRY SORBENT POWDER	6850-01-262-0484	1,150	100	1,891	4,542	5
SODIUM HYPOCHLORITE	6810-00-598-7316	100	0	51	0	10
STB, 50 LB	6850-00-297-6653	517	517	10	10	0
COLLECTIVE PROTECTION COMMODITY AREA						
FILTER, CP M13 SERIES (M14 GPFU)	4240-00-368-6291	0	0		0	0
FILTER, GP M48A1	4240-01-363-1311	0	8		0	0
FILTER SET FOR (M59, M56, SHIPBOARD)	4240-01-369-6533	0	0		0	0
MEDICAL COMMODITY AREA						
2-PAM CHLORIDE AUTOINJ	6505-01-125-3248	354,796	354,796	805,527	166,603	166,603
	6505-01-080-1986		0	19,676	4,747	4,747
ATROPINE AUTOINJ	6505-00-926-9083	354,796	354,796	822,695	167,682	167,682
	6505-00-299-9673		0	13,304	5,788	5,877
CANA AUTOINJ	6505-01-274-0951	113,323	113,323	286,585	137,909	137,909
NAAK, MKI	6705-01-174-9919	2,947	0	155	16	16
PYRIDOSTIGIMINE TAB	6505-01-178-7903	26,731	23,460	35,712	0	9,926
TETRACYCLINE	6505-00-655-8355	0	0	54,682	11,351	11,351
PATIENT WRAPS	6530-01-383-6260	0	0			
OTHER TREATMENTS						
DOXYCYCLINE CAPS, 100s	6505-00-009-5060		0		0	0
500s	6505-00-009-5063		0	62	27	27
CIPROFLOXACIN	6505-01-273-8650		0	121,755	171,050	171,050
	6505-01-333-4154		33,515	12,215	13,559	13,559

Table 4-4a. Navy Logistics Readiness Data - Non-Consumables

NOMENCLATURE	NSN	TOTAL SERVICE RQMTS	NO. REQUIRED FOR 2 MTW	STOCKS ON HAND TO INCLUDE FY99 DUE IN	PROJECTED DUE IN					
					FY00	FY01	FY02	FY03	FY04	FY05
INDIVIDUAL PROTECTION COMMODITY AREA										
<i>CB MASK</i>										
MASK, A/P22P2	NOT ASSIGNED									
MASK, MCU-2/P	4240-01-173-3443	8,863	240,000	36,844	0	0	0	0	0	0
MASK, MCU-2A/P	4240-01-284-3615/17	240,000		0	0	0	0	0	0	0
MASK, MCU-2A/P (WR) USN	4240-00-327-4148-50	189,094		174,534	0	0	0	0	0	0
CONTAMINATION AVOIDANCE COMMODITY AREA										
<i>NUCLEAR DETECTION EQUIPMENT</i>										
AN/PDR-27	6665-00-543-1435	1,642	924	1,607	0	0	0	0	0	0
AN/PDR-43	6665-00-580-9646	3,782	939	15,938	0	0	0	0	0	0
AN/PDR-56	6665-00-086-8060	163	63	63	0	0	0	0	0	0
AN/PDR-65	6665-01-279-7516	370	228	382	0	0	0	0	0	0
CP-95	6665-00-526-8645	29,782	886	679	0	0	0	0	0	0
PP-4276	6665-00-489-3106	6,054	942	841	0	0	0	0	0	0
IM-143	6665-00-764-6395	10,734	10,242	9,933	0	0	0	0	0	0
DT-60	6665-00-978-9637	137,460	137,460	150,279	0	0	0	0	0	0
<i>BIOLOGICAL DETECTION EQUIPMENT</i>										
IBAD	NOT ASSIGNED	25	25		0	0	0	0	0	0
<i>CHEMICAL DETECTION EQUIPMENT</i>										
ACADA, M22	6665-01-438-6963	535	535	300	0	0	0	0	0	0
ALARM, CAA, M8A1	6665-01-105-5623	262	48	40	0	0	0	0	0	0
CAPDS	6665-01-294-2556	323	323	322	0	0	0	0	0	0
CHEM AGENT MONITOR/ICAM	6665-01-199-4153	545	276	342	0	0	0	0	0	0
CWDD, AN/KAS-1	5855-01-147-4362	386	386	375	0	0	0	0	0	0
IMP POINT DETECTION SYSTEM	6665-LL-HAL-5532	234	234		28	45	43	40	38	0
M21 RSCAAL	6665-01-324-6637	142	0	0	0	0	0	0	0	0
DECONTAMINATION COMMODITY AREA										
DECON APPAR, M11	4230-00-720-1618	2,078	1,250	0	0	0	0	0	0	0
L/WT DEC SYS M17A3 DIESEL	4230-01-346-3122	138	64	0	0	0	0	0	0	0
COLLECTIVE PROTECTION COMMODITY AREA										
SHELTER, CP, M20/M20A1	4240-01-166-2254	670	40	0	0	0	0	0	0	0
MEDICAL COMMODITY AREA										
LITTER, DECONTAMINABLE	6530-01-380-7309	* 1,684	* 1,684	0	0	0	0	0	0	0

* Includes Marine Corps requirement

Table 4-4b. Navy Logistics Readiness Data – Consumables

NOMENCLATURE	NSN	TOTAL SERVICE RQMTS	NO. REQUIRED FOR 2 MTW	STOCKS ON HAND TO INCLUDE FY99 DUE IN	PROJECTED DUE IN	
					FY00	FY01
INDIVIDUAL PROTECTION COMMODITY AREA						
<i>OVERGARMENTS</i>						
APRON,TAP	8415-00-281-7813-16	0	0	0	0	0
IMPREG UNDERGARMENT	8415-00-782-3242-5	240	240		0	0
JSLIST (ABDO) 45 DAYS	SEE NSNs IN TABLE 4-6	319,000	133,176	66,400	88,121	85,243
SUIT, CP CAMO (BDO)	8415-01-137-1700-07	0	0		0	0
SUIT, TAP 3	8415-00-099-6962/68/70	240	240	0	0	0
	8415-01-105-2535		0	0		
SUIT, CP, OG MK3	8415-01-214-8289-92	289,665	289,665	163,361	0	0
<i>OVERBOOTS/GLOVES</i>						
BLK/GRN VINYL O/BOOTS BVO GVO	8430-01-317-3374-85		0	9,491		
	8430-01-049-0878-87	168,846	0		0	0
**CP FOOTWEAR COVERS	8430-01-118-8172	100	0		0	0
	8430-01-021-5978	339,000	339,000	295,717	0	0
CP GLOVES 7 MIL	8415-01-138-2501-04	56,472	56,472		0	0
**CP GLOVES 25 MIL	8415-01-033-3517-20	427,017	427,017	316,638	0	0
CP SOCKS	8415-01-040-3169	204,824	204,824		0	0
DISP FOOTWEAR COVER	8430-00-580-1205-06	204,824	204,824	634,717	0	0
GLOVE INSERTS	8415-00-782-2809	478,000	478,000	774,090	0	0
<i>MISC PROTECTION</i>						
CP HELMET COVER	8415-01-111-9028	82,575	82,575	0	0	0
**FILTER CAN, C2/C2A1	4240-01-119-2315	494,879	494,879	439,446	0	0
HOOD, MCU-2/P	4240-01-189-9423	91,008	91,008		0	0
CONTAMINATION AVOIDANCE COMMODITY AREA						
<i>CHEMICAL DETECTION EQUIPMENT</i>						
DET KIT, M256A1	6665-01-133-4964	10,235	159	8,980	0	0
DET PAPER, M8	6665-00-050-8529	91,567	80,924	8,109	0	0
DET PAPER, M9	6665-01-226-5589	82,357	82,357	7,763	0	0
NBC MARK SET, M274	9905-12-124-5955	522	22	180	0	0
TUBE PHOSGENE	6665-01-010-7965	1,207	0	1,753	0	0
WATER TEST KIT, M272A1	6665-01-134-0885	421	131	9	0	0
DECONTAMINATION COMMODITY AREA						
CALCIUM HYPOCHLORITE	6810-00-255-0471	9,001	9,001	8,470	0	0
DECON KIT, M258A1	4230-01-101-3984	26,402	0	198	0	0
DECON KIT, M291	6850-01-276-1905	124,410	3,233	180,835	0	0
DECON KIT, M295	6850-01-357-8456	1,645	1,645	207	0	0
DS2, 5 GAL	6850-00-753-4870	12,262	12,262	0	0	0
SODIUM HYPOCHLORITE	6810-00-598-7316	613	613	44	0	0
STB, 50 LB	6850-00-297-6653	1,525	1,525	207	0	0

Table 4-4b. Navy Logistics Readiness Data - Consumables

NOMENCLATURE	NSN	TOTAL SERVICE RQMTS	NO. REQUIRED FOR 2 MTW	STOCKS ON HAND TO INCLUDE FY99 DUE IN	PROJECTED DUE IN	
					FY00	FY01
COLLECTIVE PROTECTION COMMODITY AREA						
FILTER, GP, M48A1	4240-01-363-1311	293	293		0	0
FILTER SET FOR (M59, M56, SHIPBOARD)	4240-01-369-6533	7,226	7,226		0	0
PRE-FILTER, SHIPBOARD CPE	4240-01-348-8785	23,655	293		1,428	420
MEDICAL COMMODITY AREA						
2-PAM CHLORIDE AUTOINJ	6505-01-125-3248	144,818	144,818	757,067	0	0
ATROPINE AUTOINJ	6505-00-926-9083	144,818	144,818	914,197	0	0
CANA AUTOINJ	6505-01-274-0951	42,108	42,108	15,331	0	0
NAAK, MKI	6705-01-174-9919	113,051	113,051	17,384	0	0
PYRIDOSTIGIMINE TAB	6505-01-178-7903	70,331	70,331	281,930	0	0
TETRACYCLINE	6505-00-655-8355	1,212,205	1,212,205		0	0
PATIENT WRAPS	6530-01-383-6260	0	0		0	0
OTHER TREATMENTS*						
CIPROFLOXACIN	6505-01-273-8650	100,472	0	540	0	0
	6505-01-333-4154		100,472			
DOXYCYCLINE CAPS, 100s 500s	6505-00-009-5060		0	51	0	0
	6505-00-009-5063		0			

Table 4-5a. Marine Corps Logistics Readiness Data – Non-Consumables

NOMENCLATURE	NSN	TOTAL SERVICE RQMTS	NO. REQUIRED FOR 2 MTW	STOCKS ON HAND TO INCLUDE FY99 DUE IN	PROJECTED DUE IN					
					FY00	FY01	FY02	FY03	FY04	FY05
INDIVIDUAL PROTECTION COMMODITY AREA										
<i>CB MASK</i>										
MASK, A/P22P2	NOT ASSIGNED									
* MASK, CB, M40/M40A1	4240-01-258-0061-63	227,069	71,474	159,008	68,923	0	0	0	0	0
MASK, CB, M17A2	4240-01-143-2017-20	0	0	11,199	0	0	0	0	0	0
MASK, M24, AVIATOR	4240-00-776-4384	0	0	986	0	0	0	0	0	0
MASK, M25A1, TANK	4240-00-994-8750-52	0	0	0	0	0	0	0	0	0
* MASK, M42, TANK	4240-01-258-0064-66	5,088	5,088	4,520	0	0	0	0	0	0
MASK, MCU-2/P, -2A/P	4240-01-284-3615-17	0	0	700	0	0	0	0	0	0
<i>MISC PROTECTION</i>										
MASK COMM ADAPTOR	5996-01-381-9012	50,000	50,000	2,098	0	0	0	0	0	0
PATS, M41	4240-01-365-8241	469	469	437	0	0	0	0	0	0
CONTAMINATION AVOIDANCE COMMODITY AREA										
<i>NUCLEAR DETECTION EQUIPMENT</i>										
AN/PDR-75	6665-01-211-4217	1,203	1,203	981	0	0	0	0	0	0
AN/VDR-2	6665-01-222-1425	2,343	2,343	1,935	0	0	0	0	0	0
<i>CHEMICAL DETECTION EQUIPMENT</i>										
ACADA, M22	6665-01-438-6963	695	579	695	0	0	0	0	0	0
ALARM, CAA, M8A1	6665-01-105-5623	28	28	20	0	0	0	0	0	0
CAM 1.5	6665-01-359-9006	1,854	1,854	1,589	0	0	0	0	0	0
CAM 2.0	6665-99-725-9996	875	875	1,528	0	0	0	0	0	0
M21 RSCAAL	6665-01-382-1968	151	151	131	0	0	0	0	0	0
NBC RECON SYS, M93	6665-01-372-1303	10	10	104	0	0	0	0	0	0
DECONTAMINATION COMMODITY AREA										
DECON APPAR, M11	4230-00-720-1618	21,050	7,056	41,371	0	0	0	0	0	0
DECON APPAR, M13	4230-01-133-4124	16,864	16,864	11,983	0	0	0	0	0	0
DECON APPAR, PDDA, M12A1	4230-00-926-9488	0	0	0	0	0	0	0	0	0
L/WT DEC SYS, M17A1	4230-01-303-5225	344	0	253	0	0	0	0	0	0
L/WT DEC SYS, M17A3	4230-01-346-3122	1,350	1,350	649	0	0	0	0	0	0
COLLECTIVE PROTECTION COMMODITY AREA										
** SHELTER, CP, PORTABLE	4240-01-346-2564			231	0	0	0	0	0	0
MEDICAL COMMODITY AREA										
LITTER, DECONTAMINABLE	6530-01-380-7309	0	0	42	0	0	0	0	0	0

* 3,322 Mask M40 and 22 Mask M42 Code "H" (Unserviceable)

** - Note: The Marine Corps is using the Portable Collective Protection System for training purposes.

Table 4-5b. Marine Corps Logistics Readiness Data - Consumables

NOMENCLATURE	NSN	TOTAL SERVICE RQMTS	NO. REQUIRED FOR 2 MTW	STOCKS ON HAND TO INCLUDE FY99 DUE IN	PROJECTED DUE IN	
					FY00	FY01
INDIVIDUAL PROTECTION COMMODITY AREA						
<i>OVERGARMENTS</i>						
JSLIST (ABDO) 45 DAYS	SEE NSNs IN TABLE 4-6	696,000	621,979	44,429	35,168	31,653
SUIT, CP CAMO (BDO)	8415-01-137-1700-07	0	0	56,938	0	0
SUIT, CP, SARATOGA	8415-01-333-7573-76	596,131	596,131	526,992	0	0
SUIT, CP SARATOGA-DESERT	8415-01-333-7577-80	50,000	50,000	39,322	0	0
<i>OVERBOOTS/GLOVES</i>						
BLK/GRN VINYL O/BOOTS BVO	8430-01-317-3374-85		0			
GVO	8430-01-049-0878-87	654,000	651,146	244,224	0	0
CP FOOT COVERS	8430-01-021-5978		0	233,875	0	0
CP GLOVES 25 MIL	8415-01-033-3517-20	792,154	792,154	1,132,283	0	0
<i>MISC PROTECTION</i>						
2D SKIN, M40 SERIES	4240-01-413-1540-43	277,069	183,684	87,597	0	0
CP HELMET COVER	8415-01-111-9028	571,001	571,001		0	0
FILTER CAN, C2/C2A1	4240-01-119-2315		0			
	4240-01-361-1319	554,246	359,930	383,471	0	0
FITLER CAN, M10A1	4240-00-127-7186	2,468	0	4,111	0	0
FILTER ELEMENT, M13A2	4240-00-165-5026	27,766	0	32,133	0	0
HOOD, M40	4240-01-376-3152	343,869	343,869	2,076	0	0
HOOD, M5 FOR M25A1	4240-00-860-8987	867	0	286	0	0
HOOD, M6A2 FOR M17	4240-00-999-0420	25,973	0	10,625	0	0
HOOD, M7 (FOR M24)	4240-01-021-8695	323	0	1,026	0	0
HOOD, MCU-2/P	4240-01-189-9423		0	443	0	0
CONTAMINATION AVOIDANCE COMMODITY AREA						
<i>CHEMICAL DETECTION EQUIPMENT</i>						
BATTERY, BA-3517	6135-00-450-3528		0		0	0
BATTERY, ICAM BA-5800	6665-99-760-9742	27,136	27,136	8,808	0	0
BATTERY, ACADA BA-5590	6135-01-036-3495	20,706	20,706		0	0
DET KIT, M256A1	6665-01-133-4964	30,547	30,547	4,935	0	0
DET PAPER, M8	6665-00-050-8529	272,770	272,770	26,545	0	0
DET PAPER, M9	6665-01-049-8982		0			
	6665-01-226-5589	380,949	380,949	71,528	0	0
MAINT KITS, M273/M293	5180-01-379-6409		0		0	0
NBC MARK SET, M274	9905-12-346-4716	2,286	2,262	236	0	0
WATER TEST KIT, M272A1	6665-01-134-0885	3,159	1,115	391	0	0
DECONTAMINATION COMMODITY AREA						
DECON KIT , M258A1	4230-01-101-3984	201,568	0	39,765	0	0
DECON KIT, M291	6850-01-276-1905	408,220	33,067	162,585	0	0
DECON KIT, M295	6850-01-357-8456	29,244	29,244		0	0
DS2, 1 1/3 QT	6850-00-753-4827	21,231	21,231	9,272	0	0
DS2, 5 GAL	6850-00-753-4870	253,837	253,837	7,100	0	0
DS2, M13 CAN	6850-01-136-8888	32,451	32,451		0	0
NITROGEN CYLINDERS	4230-00-775-7541	27,993	27,993	18,041	0	0
STB, 50 LB	6850-00-297-6653	7,410	1,264	4,761	0	0

Table 4-5b. Marine Corps Logistics Readiness Data – Consumables

NOMENCLATURE	NSN	TOTAL SERVICE RQMTS	NO. REQUIRED FOR 2 MTW	STOCKS ON HAND TO INCLUDE FY99 DUE IN	PROJECTED DUE IN	
					FY00	FY01
COLLECTIVE PROTECTION COMMODITY AREA						
FILTER, CP, M12A2 (M14 GPFU)	4240-01-365-0981	1,108	1,108		0	0
FILTER, CP, M13 SERIES (M14 GPFU)	4240-00-368-6291	1,122	1,122		0	0
FILTER, CP, M18A1	4240-01-365-0982	3,236	3,236	478	0	0
FILTER, CP, M19	4240-00-866-1825	1,674	1,674	132	0	0
FILTER, GP, M48A1	4240-01-363-1311	644	644		0	0
FILTER SET FOR (M59, M56, SHIPBOARD)	4240-01-369-6533		0		0	0
MEDICAL COMMODITY AREA						
2-PAM CHLORIDE AUTOINJ	6505-01-125-3248	500,505	500,505	70,433	0	0
ATROPINE AUTOINJ	6505-00-926-9083	500,505	500,505	152,047	0	0
CANA AUTOINJ	6505-01-274-0951	142,481	142,481	45,343	0	0
NAAK, MKI	6705-01-174-9919	405,446	405,446		0	0
* PYRIDOSTIGIMINE TAB	6505-01-178-7903	289,075	289,075	2,247	0	0
PATIENT WRAPS	6530-01-383-6260		0		0	0

* 9,997 not reported due to being repackaged to comply with FDA requirements

Table 4-6. Defense Logistics Agency Logistics Readiness Data - Consumables

NOMENCLATURE	NSN	STOCKS ON HAND TO INCLUDE FY99 DUE IN	PROJECTED DUE IN	
			FY00	FY01
INDIVIDUAL PROTECTION COMMODITY AREA				
OVERGARMENTS				
CAPE, AIRCREWMAN	8415-01-040-9018	13,913	8,500	0
CP UNDERCOVERALL	8415-01-040-3141			
CHEM PROT UNDERGARMENT TOP	8415-01-363-8692-00	41,673	1,800	0
CPU DRAWERS	8415-01-363-8683-91			
EOD TAP BOOTCOVER	8430-00-820-6295- 6306	794	2,758	0
IMPREG UNDERGARMENT	8415-00-782-3243			
JSLIST SUITS		0	250,000	250,000
Wood - Coat	8415-01-444-1163/-1169/-1200/38/49/65/70			
Wood Trousers	8415-01-444-1435/39/-1613-/2308/10/25/38			
Desert Coat	8415-01-444-5902/05/13/26/-6116/31/38			
Desert Trousers	8415-01-444-5417/5504/06/-5892/93/98/-5900			
SCALP (TAN AND GREEN)	8415-01-333-0987 8415-01-364-3320			
SUIT, AIRCREW, CWU-66/77P	8475-01-328-3454(S)		25,000	8,750
SUIT, CP CAMO (BDO)	8415-01-137-1700-07		0	0
SUIT, CP CAMO-DESERT - 3 color	8415-00-327-5347-53		0	0
SUIT, CP CAMO-DESERT - 6 color	8415-01-324-3084-91		0	0
SUIT, CP, OG MK3	8415-00-214-8289-92		0	0
SUIT, CP, SARATOGA	8415-01-333-7573-76		0	0
OVERBOOTS/GLOVES				
BLK/GRN VINYL O/BOOTS	8430-01-317-3374-85	374,229	122,310	0
CPO FOOT COVERS	8430-01-021-5978		0	0
CP GLOVES 7 MIL	8415-01-138-2501-04	89,381	27,000	0
CP GLOVES 14 MIL	8415-01-138-2497-00	697,141	0	0
CP GLOVES 25 MIL	8415-01-033-3517-20	431,081	150,000	0
CP SOCKS	8415-01-040-3169	94,711	0	0
DISP FOOTWEAR COVER	8430-00-580-1205-06	48,829	10,400	0
MISC PROTECTION				
HOOD, MCU-2A/P	4240-01-189-9423		0	0
CP HELMET COVER	8415-01-111-9028	182,865	246,000	0
CONTAMINATION AVOIDANCE COMMODITY AREA				
CHEMICAL DETECTION EQUIPMENT				
BATTERY, BA3517	6135-00-450-3528	0	15,544	15,544
MAINT KITS, M273/M293	5180-01-108-1729 5180-01-379-6409	2,066	468	468
TUBE, DET, PHOSGENE GAS	6665-01-010-7965	182	308	308
DECONTAMINATION COMMODITY AREA				
CALCIUM HYPOCHLORITE	6810-00-255-0471	54,184	65,980	65,980
DRY SORBENT POWDER	6850-01-262-0484	36	190	0
STB, 50 LB	6850-00-297-6653	1,020	84	84

Table 4-6. Defense Logistics Agency Logistics Readiness Data - Consumables

NOMENCLATURE	NSN	STOCKS ON HAND TO INCLUDE FY99 DUE IN	PROJECTED DUE IN	
			FY00	FY01
COLLECTIVE PROTECTION COMMODITY AREA				
PRE-FILTER, SHIPBOARD CPE	4240-01-348-8785		588	588
MEDICAL COMMODITY AREA				
2-PAM CHLORIDE, AUTOINJ	6505-01-125-3248	237,887	250,000	250,000
ATROPINE AUTOINJ	6505-00-926-9083	375,172	340,000	340,000
CANA AUTOINJ	6505-01-274-0951	267,034	300,000	300,000
NAAK, MKI	6705-01-174-9919	552,000	0	0
PYRIDOSTIGIMINE TABLETS	6505-01-178-7903	256,196	100,000	100,000
LITTER, DECONTAMINABLE	6530-01-380-7309	3,500	1,518	0
MES CHEM ACT PAT TR	6545-01-141-9469	164	0	0
MES CHEM AG PAT DECON	6545-01-176-4612	108	0	0

APPENDIX 2 FIELDDED NBC DEFENSE ITEMS - ISSUES AND CONCERNS
--

NBC defense items are generally used in combination to form a system or subsystem for a particular function. Therefore, this report will address items used as a system. These systems are categorized into five functional areas:

- Contamination Avoidance
- Individual Protection
- Collective Protection
- Decontamination
- Medical

1. CONTAMINATION AVOIDANCE

Contamination avoidance programs generally include equipment that is used to conduct NBC agent reconnaissance, detection, and identification. This area represents approximately half of the annual DoD NBC defense RDT&E budget. Due to recent type-classification of several programs that are intended to modernize contamination avoidance programs, this area has an unusually high number of developmental programs, as compared to other commodity areas. Many programs will complete their fielding beyond FY05.

Current numbers of biological detection devices, to include the Biological Integrated Detection System (BIDS) and Interim Biological Agent Detector (IBAD), are insufficient as measured against the MTW requirements. Automatic biological agent point detectors and stand-off detectors are currently in development, and will not be deployed in significant numbers prior to FY02. The USAF has no fielded biological agent detection capability other than the limited quantities of Portal Shield ACTD biological detectors.

The combined total of chemical agent detection systems remains at moderate risk, but will improve slowly as the M22 Automatic Chemical Agent/Detector (ACADA) supplements the M8A1 Automatic Chemical Agent Alarm. An Army initiative to inspect and repair M8A1 alarms at Anniston Army Depot has resulted in the quick assessment and return of 1,600 units to the field. Another 1,500 alarms were coded as requiring depot maintenance and are undergoing repairs. As a result of this program, the Army has no shortage of alarms for training purposes and there is no longer an acquisition gap between the combined acquisition of M8A1 and M22 alarms.

Although the combined number of CAM/ICAMs reported by the Services places them in the moderate risk category, the actual number available for use by the Marine Corps is much lower. Collectively, 59% of their total inventory of CAM/ICAM 1.5 and CAM/ICAM 2.0 is currently at the Marine Corps Logistics Base in Albany, GA awaiting repair. At present, the repairs are unfunded.

The M21 Remote Sensing Chemical Agent Alarm (RSCAAL) is at low risk with present quantities exceeding the two MTW requirement. The M93A1 NBCRS is currently fielded at less than half of its projected requirements. This system adds improved mass spectrometer sampling system along with stand-off chemical vapor detection. Several units continue to use trained reconnaissance personnel in HMMWVs and APCs, thus moderating this risk as continued fielding and developmental systems enter the inventory. Also, the M93 NBC Recon System completes the fill in the interim when added to the on-hand quantity of M93A1 systems.

Traditional consumables in this commodity area (M8 and M9 detection paper, M256A1 kits and M272A1 water test kits) are available in sufficient quantities to meet wartime requirements. Some shortages exist in individual Services, but overall there is little risk. Shelf life concerns may change this projection; this area remains under review.

The Army and Air Force radiac programs are expected to just meet the two MTW scenario average requirements. The Army National Guard still has a large number of obsolete radiacs. These will be replaced in the near future by the AN/VDR-2 which is available in sufficient quantities through the depot system. The Navy has small quantities of older radiacs still in the inventory, which will be replaced through a modernization program currently underway. The Marine Corps has most of the required AN/VDR-2s and about three-quarters of its AN/PDR-75s as compared to the MTW requirements, putting it in a moderate risk category. While Army stores or industry could compensate for this shortfall, it represents a potential risk, especially at the onset of any contingency.

2. INDIVIDUAL PROTECTION

Currently fielded protective suits and masks are designed to protect against all known CB threat agents. Past Service-unique requirements led to Service-specific procurements and some duplication in capability resulting in the procurement of six different chemical protective suits and six different masks. This has caused difficulties in meeting current needs and exacerbated logistics planning. Fielding of the M40/42 protective masks, JSLIST protective suits and the MULO boot has begun to resolve many of these former challenges.

2.1 Protective Ensembles

The Services are continuing acquisition of the Joint Services Lightweight Integrated Suit Technology (JSLIST) suits as a replacement for the BDO and other chemical protective suits. As such, the protective suits should be viewed as a system with the older suits providing readiness stocks until the end of their service life. The initial JSLIST contracts did not include surge option clauses. Defense Supply Center Philadelphia (DSCP), whose solicitations include the surge option as a requirement, took management of JSLIST in FY98. By examining the year-by-year status of protective suits, a number of older suits still within service life were added to the number of JSLIST suits purchased by that year and matched the total against the requirements. In FY03, the services have sufficient protective suits to meet requirements as projected for the average two MTW requirements. However, beginning in FY05, the number of suits on hand will fall below total Service requirements, as the service life of older protective suits, such as BDOs, expires in

large quantities. These calculations include the approximately \$58 million Quadrennial Defense Review plus-up per year allocated to purchasing protective suits, which began in FY98.

The Battle Dress Overgarment (BDO) is reaching its maximum extended shelf life limit (14 years), and the Services have no plans for new production. There are no companies currently manufacturing the BDO. The Army and Air Force have sufficient suits on hand in war reserves to sustain its requirements for the near term. The Saratoga suit, purchased by DSCP for the Marine Corps, is also out of production, but current stocks will sustain the Marine Corps until the JSLIST is available in adequate numbers. The Navy is relying on existing stocks of their Mark III chemical protective suit (also out of production) as stocks of JSLIST are being procured.

Armor crews and aircrews require special protective ensembles to integrate with their weapon systems. Services have sufficient numbers of aircrew suits to meet requirements, given the smaller total requirements for aircrews (relative to ground troops). An exception is the Chemical Protective Underoverall, which is now obsolete. It is replaced by the CWU-66/77 which remains low in inventory resulting in a moderate risk rating. To protect armor crewmen when they exit their vehicles, the Services have developed the Suit Contamination Avoidance Liquid Protection (SCALP), which is available in sufficient quantities to meet MTW requirements.

The Services have adequate stocks of 7, 14, and 25-mil chemical protective gloves on-hand for contingency use. Recent DoD surveillance tests have validated the protective qualities of the existing butyl rubber glove stocks. The results from calculating the number projected to be on hand for FY05 exceeds the projected average MTW requirement. The status of the Services on-hand inventories has allowed DLA to pursue an Industrial Base Maintenance Contract (IBMC) with both current manufacturers (Siebe North, Inc., Charleston, SC, and Guardian Corp., Willard, Ohio) to sustain the industrial base with "War Stopper" funding. The IBMC is to maintain the equipment only.

Chemical Protective Footwear Covers, also known as the "fishtail" boot, have been out of production for several years. Their shortages are supplemented by the Black/Green Vinyl Overboot (BVO/GVO), which is the interim chemical protective footwear until the JSLIST MULO boots have been fielded. Because the GVO's primary purpose is not chemical protection, current contracts do not include surge option clauses. Again, one should view protective footwear as a system with older GVOs providing readiness stocks until the MULO is fielded in sufficient quantities. Currently, the total DoD inventory shows adequate quantities of protective footwear, resulting in low risk assessment. The USMC is the only service reporting a shortage of footwear, but DLA can fill their shortfall.

2.2 Eye/Respiratory Protection

The Services continue modernizing their chemical protective mask inventories. Different versions of the protective mask were developed to meet the requirements of different military occupational specialties (*e.g.*, air crew, tank crew, *etc.*). For the Army and Marine Corps, the M40 (for generic use) and M42 (for armor crew members) series masks are replacing the M17

and M25-series masks, respectively. Some Army aviation units are still equipped with the old M24 mask, which will be replaced by the M45 mask. The M43-series mask, designed to be used by Apache equipped units, was in fact issued to all types of aviation units. It is being replaced by the M48 (Apache) and M49 (general aviation) series mask. The M45 will replace the M49 as the general aviation mask. This modernization effort is still ongoing; not all units have replaced their M43-series masks. All of these masks are at low risk, as the combined numbers of all aviator masks on hand exceeds the requirement. These newer masks provide increased protection, improved fit and comfort, and compatibility with most Services' weapons systems' optics and sights.

The Marine corps is performing a product improvement program (PIP) to modify the existing M40/M42 series mask. The PIP will be completed in Fiscal Year 2004. PIP actions include installation of a new nose cup, polycarbonate eye lenses, drink tube coupling, and drink tube quick disconnect: banding of the outlet valve housing: and laser etching serial numbers on the mask. The new components and banding procedure will improve the mask's durability and protective capability requirements established by the Marine Corps and eliminate inadvertent damage to the mask by the unit (*i.e.*, painting a number on the head harness, engraving in the eyelens-retaining ring). The cost to perform the PIP is estimated at \$12M with the Marine Corps saving approximately \$10M by performing the rebuild vice buying new modified masks.

The MCU-2A/P mask is designed to meet the needs of the Air Force ground crews, Navy shipboard and shore-based support missions, and Marine Corps rotary wing forces. The number of these masks on hand generally exceeds the requirement. The USAF has some shortages in masks and does not have second skins to provide complete personal protection. It will continue to be the mainstay of these units until the Joint Service General Purpose Mask is fielded, which will also replace the M40/42 masks. The Aircrew Eye/Respiratory Protection (AERP) mask is specially designed to enable pilots of high performance aircraft to conduct missions in a contaminated environment. Quantities of this mask are currently below the MTW requirement, making this a moderate risk.

In order to provide complete protection to our forces on the contaminated battlefield, particularly from liquid chemical agents, protective hoods and helmet covers are required as part of the individual protective ensemble. The protective hood for the M40 is rated as low risk. It is being replaced by the second skin for the M40 series mask, which is a high risk program with only 60 percent of requirements on hand by FY04. The MCU-2P hood is at low risk with an abundant inventory. Protective hoods for the M17-series, M24, and M25A1 masks are also in good supply, and thus are not a readiness issue. These masks are leaving the inventory, however. The Chemical Protective Helmet Cover is also available in sufficient quantities.

Filters and canisters provide the active ingredients that absorb the chemical and biological agents and provide the essential protection required. The C2/C2A1 canister is used with the M40, M42, M43, M45, M48, M49 and MCU-2/P masks. The number on hand falls short of the MTW requirements as a moderate risk. The M13A2 filter element exceeds requirements, but will be leaving the inventory with the retirement of the M17-series mask. The M10A1 filter

canister used on the M24/25 is short of the requirement, but these masks will also leave the inventory and will not be a readiness problem.

3. COLLECTIVE PROTECTION

There are two general categories of collective protection: stand-alone shelters and integrated systems. Integrated collective protection equipment is component equipment designed to provide protection against CB agents through the use of filtered air under positive pressure to a variety of facilities, vans, vehicles, aircraft and ships. Filters for these integrated collective protection systems (CPS) are in short supply due to low peacetime demand and low production quantities. The increased emphasis on procuring individual protection and contamination avoidance equipment has resulted in a corresponding decrease in procurements of shelters and large collective protection filters.

The Air Force has expressed interest in a greater collective protective shelter capability. Combined with the Navy's increasing shipboard collective protection filter requirements and the Army and Marine Corps traditional integrated vehicular systems and tactical shelter requirements, the near-term MTW requirements for large carbon-based filters have outpaced current inventories even aided by industrial surge capability. As a result, much of this sector is assessed as high risk, though the risk is primarily due to the level of funding rather than technical shortfalls. Most of the filter manufacturers retain the industrial capability to produce them.

In the near term, the M51 shelter will be replaced by the new Chemical and Biological Protective Shelter (CBPS). All Army M51 shelters have been coded as unserviceable. The CBPS is presently in production with fielding to initiate in 3Q00. Both Army and Air Force field hospitals are being integrated with environmentally controlled collective protection. The Army's Chemically Protected Deployable Medical Systems (CP DEPMEDS) achieves collective protection through the integration of the M28 Simplified CPE, chemically protected air conditioner, heaters, water distribution and latrine and alarm systems. The M28 Simplified CPE is in production and chemically protected heaters and air conditioners initiated production in FY99. The FY00-02 POM fully supports the production of the required 17 CP DEPMEDS. In FY00, production will initiate for remaining M28 CPE, CB protected water distribution and latrine systems, CB ISO Shelter Seals and Low Pressure Alarms.

The M20-series Simplified CPEs are used to provide a contamination-free, environmentally controlled work space for Echelon I and II forward area medical treatment facilities. Current funding levels, however, only will meet Force Package I requirements. There are some Force Package II units designated for deployments into high threat regions that will not be equipped with M20 shelters. This leads to an assessment as high risk. Current policy is that the M20/M20A1 Simplified CPE is a free issue item with no requirement to stock other than spares replenishment. The Marine Corps has Portable Collective Protection Shelters (PCPS) but does not plan to field them. The Marine Corps is instead using them for training purposes. The M20A1 SCPE is by default the only modern collective protection stand-alone shelter outside of the medical community in the inventory.

The Services have continued to improve integrated collective protection systems in armored vehicles and vans. All modern armored vehicles and armored vehicles in development have either filtered air systems, hybrid collective protection or full collective protection systems designed into their chaises. Notable progress has been made in providing shipboard collective protection. By the year 2000, most Naval ships that have close-in support roles (including amphibious ships, gunfire support combatants, and new logistics support ships) will contain significant CPS capabilities.

Collective protection filters for integrated systems (such as armored vehicles, ships and planes) continue to suffer from low stocks. While the Services have been proactive in selecting more capable industrial sources, actual procurement and storage of these filters to MTW requirements has not been initiated for all filters. As a result, stocks of some filters remain at a low level. However, the filters associated with the 200 CFM Particulate Filter Set for Shipboard Collective Protection Systems are being procured in sufficient quantities. Continued difficulties in obtaining a strong industrial base in this field compounds the issue of fielding and sustaining these items.

4. DECONTAMINATION

Current decontaminants are highly effective against all CB agents, but most present environmental hazards and are manpower intensive. The services are attempting to find environmentally safe decontaminants that are less labor intensive.

Basic soldier skills for decontamination of vehicle and crew-served weapons rely on the M11 Decontamination Apparatus, Portable (DAP) and M13 DAP. While the M11 is assessed as posing low risk, there are insufficient quantities of the M13 DAP as measured against the MTW requirements. The 1½ quart M11 can be used in place of the 14-liter M13 DAP, but they do not fulfill the same exact capability (in part due to the volume of DS-2).

The M17-series Lightweight Decontamination System (LDS) is used to provide operational equipment decontamination in many battalion-level units and dual-purpose (smoke/decontamination) chemical companies. The Air Force employs the M17 at the squadron level for operational equipment decontamination. The M17 is assessed as a moderate risk, due in part to a delay in rebuilding several hundred systems caused by a lack of funding since 1990. There is still a large mix of different models in the inventory, forcing the Services to retain a large number of differing spare parts to maintain the different models. Based on projected inventory, should spare parts become difficult to obtain for the different models, the risk may become high. Overall, this risk should drop as more systems are produced and the older models are upgraded or replaced. The Marine Corps is upgrading all of their LDS to the diesel engine. The Air Force is deleting stocks of A/E32-U systems by attrition, modifying existing M17s to M17A2s, and procuring additional M17A3s to satisfy shortages.

In the Army, the M12A1 Power-Driven Decontamination Apparatus (PDDA) and the M17A3 LDS are the primary pieces of equipment used to decontaminate vehicles, crew-served equipment and large areas of terrain. The M12A1 is assessed as low risk. Although there are

sufficient quantities on-hand of the M12A1, the maintenance requirements, due to the age of this item, limit its full utilization and may increase its risk. The M21/M22 Modular Decontamination System will displace 200 M12A1 PDDAs over the POM period, resulting in a high-low mix of technology. By FY02, the on-hand quantities of the M21/M22 MDS alone should satisfy the two MTW requirement. Additionally, the Marine Corps is replacing their M12A1 PDDAs with the M17-series LDS.

The Army and Marine Corps plans for stocking containers of DS-2 (5-GAL and M13 Can) are below the MTW requirements expected for decontamination operations. The situation is compounded by a decreasing availability of DS-2. Bulk DS-2 stored at Seneca Army Depot is currently undergoing lot testing to ascertain how much has deteriorated and is unusable. As a result, stocks of DS-2 are being released for contingency use only. While less hazardous replacement decontaminants, such as sorbent decon are being developed, the quantities and packaging of current decontaminants present potential risk. The projected stockage of STB meets average MTW requirements, but has been considered a high-risk category in the past. Slight shortages in calcium hypochlorite and sodium hypochlorite can be made up by the industrial base, using commercially available alternatives. These increased requirements come as a result of increased attention to the need for decontamination capabilities in the 2 MTW scenario, and will be further refined. Continued monitoring is recommended.

The shelf life of the M258A1 Skin Decontamination Kit expired on 30 July 1999. Its replacement, the M291 Skin Decontaminating Kit, became the primary item used in personnel decontamination. Although M258A1 stocks are no longer available to supplement inventory of the M291, the risk assessment is low. Projected buys are expected to meet the 2 MTW requirements, but may need to be augmented to meet the total service requirements. Rohm & Haas, Co., the sole supplier of the resin, sold the mixing and packaging equipment they used to manufacture the M291 Decontaminating Kit. Pine Bluff Arsenal, Arkansas, set up a production line and began to manufacture the M291 Decontaminating Kit in October 1996. Rohm & Haas continues to provide the XE-555 resin components. True Tech Inc. is blending the components to make the XE-555 resin. Alternatives to producing a kit that does not use the XE-555 resin are being studied, including novel sorbent decontaminants. There are also a number of options being explored to retain this "at risk" technology.

The projected stockage of the M295 Individual Equipment Decontamination Kit puts it in a low risk category when compared with 2 MTW requirements. The M295 Decontamination Kit uses the same resin mix as the M291 Decontaminating Kit, and began delivery in December 1997. True Tech Inc. has been producing this item. Increased funding for its procurement would maintain the low risk.

5. MEDICAL

Medical NBC defense items are used to counteract the effects of exposure to chemical, biological, or nuclear agents through pre-treatment, vaccines, or post-treatment. Current projections for medical chemical defense material indicates that sufficient quantities should be on hand through the POM years and present overall low risk. Quantities of Nerve Agent Antidote Kits

(NAAK), and Atropine and 2-PAM Chloride Autoinjectors now support two MTW requirements. Convulsant Antidote Nerve Agent (CANAs), and Nerve Agent Pyridostigmine Pretreatment (NAPP) Tablets (also known as PB Tablets) saw their risk increase because of the recalculated requirement for consumables. This report includes medical treatments for biological warfare agents and cyanide exposure along with the addition of new chemical treatments.

NAPP is still an Investigational New Drug (IND) for the use as a nerve agent pre-treatment. The U.S. Army Medical Materiel Development Activity (USAMMDA) has continued to work with the FDA for approval. Defense Supply Center – Philadelphia (DSCP) is working with ICN Pharmaceuticals to establish a requirements contract for the manufacture of NAPP.

The sole supplier to DoD for NAAK, atropine autoinjectors, pralidoxime autoinjectors and CANAs is Meridian Medical Technologies, St Louis, Missouri. The medical chemical defense production line is being maintained with an IBMC. Meridian is an U.S. company but it obtains its atropine for the autoinjectors from a German supplier. Currently there is no domestic source for this drug. Pralidoxime and diazepam (CANAs) for the autoinjectors is available from U.S. sources.

Patient Chemical Wraps have not been procured since 1991 and are made of the BDO materiel. USAMMA and the AMEDDC&S are currently assessing several versions of the patient wrap before initiating new procurement of this item. All services are procuring the new decontaminable litter, but in limited quantities, for first line units. There is a very large stockpile of canvas litters that can be used once in an NBC environment and then destroyed. As the canvas litters are depleted, they will be replaced with the new nylon decontaminable litter.

The Office of the Surgeon General has centrally programmed and funded the Army's Medical Chemical Defense Materiel since 1994. USAMMA has procured, stored and maintained this materiel for the Army in strategic locations for early deployers and forward deployed forces as Division Ready Brigades (DRB) sets, which support 5,000 personnel each. The Air Force, Navy and Marine Corps maintain their medical CB materiel in decentralized unit locations. Visibility of on-hand assets has been improved with the release of the Joint Medical Asset Repository, which is the Class VIII (medical) portion of JTAV.

Medical research programs continue to explore medical countermeasures to deter and defeat the use of biological warfare agents against U.S. forces. The Joint Program Office for Biological Defense (JPO-BD) has awarded a prime systems contract through the Joint Vaccine Acquisition Program (JVAP) for the development, FDA licensure, storage, and production of vaccines against DoD's identified potential biological warfare agents. Currently, the U.S. total force (active and reserve forces) is being vaccinated against anthrax, which is considered the primary high-threat BW agent. The anthrax vaccination program is a three-phase program, starting with the troops serving in-or identified to deploy to-the two high-threat areas where hostile anthrax-use poses the greatest potential danger. The overall vaccination program is on-schedule and will take between seven and eight years to complete for all service members (to include new personnel acquisitions as the program extends over the entire period).

JPO-BD assisted the sole domestic supplier of anthrax vaccine to maintain its FDA licensure and to transition the production facility to private ownership in FY98. A follow-on contract was also awarded in FY98 to ensure sufficient anthrax vaccine to meet the DoD vaccination program. Other vaccines (or combinations) are currently in various stages of development and testing to protect against other BW agents identified in the Chairman of the Joint Chiefs of Staff (CJCS) validated BW threat list. In the area of medical therapeutics, the Department is maintaining a stockpile of antibiotics (*e.g.*, ciprofloxacin, doxycycline, *etc.*) sufficient to address the treatment needs of potential BW exposures, where such treatment is medically indicated.

The DoD/FDA Shelf Life Program was developed by the Department of Defense Health Affairs and the Military Medical Departments in response to Congressional concern over the conservation of military medical resources. The program's focus is to save replacement cost of date sensitive medical materiel especially medical materiel in War Reserve Stocks, Medical Biological Defense Materiel Programs and Medical Chemical Defense Materiel Programs. The Joint Readiness Clinical Advisory Board (JRCAB) coordinates with the FDA for items the Services wish to have tested. The FDA requests samples from the JRCAB and the Services. The samples have an initial potency test performed, followed by a 90-day stress test, and then a final potency test. The potency results are compared against a degradation curve, and a new potency period is assigned. The FDA sends the information to the JRCAB and Services who disseminate instructions to extend and re-mark or destroy the materiel to activities and units worldwide. The same lots are subjected to yearly retest and subsequent extensions until the materiel fails or is removed for lack of sufficient on-hand quantities required for testing. The Army maintains its extended materiel at Meridian Medical Technologies for use by Force Package 3 and 4 units. The Air Force maintains its materiel at its local medical logistics activities that re-mark the materiel and maintains it for the deploying units. The Navy and Marines re-mark the materiel and maintain it with the unit.

(INTENTIONALLY BLANK.)

Chapter 5

Nuclear, Biological, and Chemical (NBC) Defense Readiness and Training

5.1 INTRODUCTION

The Services' vision for Joint NBC Defense Management is: *America's Armed Forces trained and ready for the 21st Century, protecting our nation and its forces against nuclear, biological and chemical threats.* The Joint NBC Defense Program builds on the successes of each Service to develop a viable Joint orientation to NBC defense capabilities, which includes Joint requirements documents; Joint doctrine and tactics, techniques, and procedures; Joint modeling, simulation, and wargaming; and Joint professional training.

5.2 NBC DEFENSE DOCTRINE

Joint and Multi-Service Doctrine. Joint Publication 3-11, *Joint Doctrine for Nuclear, Biological, and Chemical (NBC) Defense Operations*, final draft 26 Nov 99 provides guidelines for the planning and execution of NBC defensive operations. Its focus is on the NBC threat, national policy, and considerations peculiar to the preparation and conduct of NBC defense. These considerations include principles of theater NBC defense, logistics support, medical support, training, and readiness.

The Joint Service Integration Group (JSIG) is working with the Air Land Sea Application (ALSA) Center, U.S. Army Chemical School (USACMLS), and the Joint Warfighting Center to lead the effort in the development of multi-service NBC defense doctrine. Currently ALSA is revising FM 3-4-1, *Multi-Service Procedures for NBC Defense of Fixed Sites, Ports, and Airfields*, in coordination with all the Services. Currently, the publication is in final review, incorporating Service-wide comments. Expected publication date is February 2000. Preliminary response to the publication has been favorable and the draft is being used as guidance in several locales.

Multi-National Doctrine. The U.S. Army Nuclear and Chemical Agency (USANCA) has been delegated the DoD representative for international standardization of NBC operational matters. USANCA participates in the following North Atlantic Treaty Organization (NATO) groups:

- NBC Defense Interservice Working Party (NBCWP) under the Military Agency for Standardization,
- Land Group 7 (LG. 7)—NBC Equipment—under the NATO Army Armaments Group (NAAG),

- Working Group 2 (LG. 7)—Low Level Radiation in Military Environments,
- Challenge Subgroup (LG. 7)—Chemical/Biological Toxicity Challenge Levels,
- Technical Subgroup (LG. 7)—Nuclear Weapons Defense, and
- ATP-45 (NBCWP) NBC Warning/Reporting.

USANCA also has been delegated as the representative in the ABCA Quadripartite Alliance (US, UK, Canada, Australia) in the Quadripartite Working Group (QWG) for NBC Defense. In that group, USANCA also participates in the RADIAC Information Exchange Group (IEG). The USACMLS participates with USANCA to incorporate NBC group agreements in revising existing manuals.

The USACMLS has been delegated as the representative at the NATO Training Group (Joint Services Subgroup) in addition to providing representation and subject matter expertise to support USANCA at NATO/QWG meetings as required. This includes consultation to coordinate the official US position on NBC defense issues prior to international meetings.

5.2.1 Joint NBC Defense Doctrine Program Management

The NBC defense program management strategy described in Chapter 1 provides the mechanism to assist the Joint Staff in the further development of the Joint NBC defense doctrine program. The JSIG coordinates with the Services to ensure the program is realistic and meets the needs of the Joint community.

5.2.2 Joint NBC Defense Doctrine Development Program

The USACMLS has been tasked by the Joint Staff to revise Joint Pub 3-11, *Joint Doctrine for Nuclear, Biological, and Chemical (NBC) Defense*. The title of the Joint Publication has been changed to *Operations in an NBC Environment*. This change reflects an increased emphasis on sustaining operations in a contaminated environment. Release of a final coordination draft of Joint Pub 3-11 to be distributed among the combatant Commands, Services, and the Joint Staff is planned for March 2000.

The USACMLS also provided exercise and training support to CINCs and various organizations throughout the year. Subject matter experts were provided to the Army War College for their “Strategic Crisis Exercise”, Crisis Action Exercises, to the Atlantic Command (ACOM) for Joint Task Force (JTF) training, and to Exercise Silent Breeze II for briefing support.

The U.S. Army Medical Department Center and School (USAMEDDC&S) is the lead agency for the revision of Joint Publication 4-02, *Doctrine for Health Service in Joint Operations*. The preliminary coordinating draft was completed, staffed, and the Medical Doctrine Working Party reviewed and incorporated critical and major comments. A final draft is being prepared. The final draft will be forwarded to the Joint Staff for worldwide staffing. The revision contains additional information on the medical aspects of NBC defense.

USAMEDDC&S also is assisting USACMLS in revising the medical support aspects of Joint Pub 3-11.

5.2.3 Army Medical Doctrine Development Program

Multi-Service Doctrine. The FY99 effort consisted of initiatives to develop new Army Medical Department (AMEDD) NBC defense doctrine products, provide AMEDD input to other service NBC doctrine publications, and provide input to multinational medical NBC procedures. Field Manual (FM) 8-284/NAVMED P-5042/AFMAN (I) 44-156/MCRP 4-11.1C, *Treatment of Biological Warfare Agent Casualties* is complete. The FM will be printed and distributed in FY00. FM 8-283, *Treatment of Nuclear Warfare Casualties and Low-Level Radiation Exposure* is under development. This manual will be developed as a multi-service publication. FM 8-10-7, *Health Service Support in a Nuclear, Biological, and Chemical Environment* is being revised and developed as a multi-service publication. Doctrine for nuclear, biological, and chemical-environment (NBC-E) will be developed and incorporated into current and new manuals as the technology allows. The area of NBC-E includes the effects of long-term exposure to low-levels (sub-clinical levels) of NBC agents, industrial radiation, biological, and chemical hazards. Available material on NBC-E will be included in the revision of FM 8-10-7.

Multi-National Doctrine. The Office of The Surgeon General (OTSG, DASG-HCO) has been designated the head of Delegation for the NBC Medical Working Group for standardization of NBC medical operational matters. OTSG, DASG-HCO participates in or coordinates with the following NATO groups:

- NBC Defense Working Group
- NBC Medical Working Group—Head of Delegation
- Land Group 7 (LG.7)—Joint NBC Defense
- Working Group 2 (LG.7)—Low Level Radiation in Military Environments
- Challenge Subgroup (LG.7)—Chemical/Biological Toxicity Challenge Levels
- General Medical Working Party, Aeromedical Working Group
- Research Technology Area/Human Factors Medical Panel NBC Medical Subgroups.

The AMEDD participated in numerous NATO medical NBC procedural product reviews, resulting in several NATO Standardization Agreements (STANAGs) being updated. Further, the AMEDD participated in a Quadripartite Working Group to develop and update additional Quadripartite Standardization Agreements (QSTAGs), which are medical NBC procedural products. STANAGs and QSTAGs are reviewed for integration of these agreements into Army-specific doctrine literature products as well as multi-service medical doctrine products for which the AMEDD is the proponent.

5.2.4 Air Force Doctrine Program

HQ USAF/XONP has been working with the Air Force Doctrine Center to fill a void in Air Force Doctrine by developing an overarching Counter-NBC Operations Doctrine for the USAF. The new document will bring the Air Force into compliance with DoD Directive 2060.2,

which requires each Service to develop a counter-NBC doctrine, and will outline integration with Joint and Multi-Service doctrine. USAF guidance historically has focused on passive defense, whereas the new document will broaden the scope to include essential areas of counterforce, active defense, and command, control, communications and computers, intelligence, surveillance, and reconnaissance (C4ISR). The doctrine document is in final review and should be in formal coordination in the second quarter of FY00.

The Air Force Surgeon General (HQ USAF/SGXR) has been participating with the Army in development of a medical doctrine field manual, *Treatment of Biological Warfare Agent Casualties*. A Concept of Operations (CONOPS) was completed that standardized USAFE wartime medical contamination control operations. During FY99 SGXR has also participated in the review of numerous NATO Standardization Agreements that were updated during the year.

5.2.5. Navy Doctrine

The Navy has been actively participating in revisions to all phases of Joint, Multi-service and Service-unique Chemical Biological Defense Doctrine. Navy revisions have been incorporated into the latest version of Joint Pub 3-11, *Joint Doctrine for Nuclear, Biological, and Chemical (NBC) Defense Operations*. FM 3-4-1, *Multi-Service Procedures for NBC Defense of Fixed Sites, Ports, and Airfields*, has been revised in coordination with the other Services and has received a Naval Warfare Publication designation as NWP 3-11 23. The Navy unique publication NWP 3-20.31 *Surface Ship Survivability* also has undergone extensive revisions to update shipboard Chemical Biological Defense actions and provide better coordination with existing multi-service publications.

5.2.6 Marine Corps Doctrine

The Marine Corps continues to systematically review multi-service NBC doctrine. The Marine Corps has reviewed a number of NATO Standardization Agreements as well as multi-service doctrine with both the U.S. Army and the U.S. Navy. The Marine Corps has completed a new Marine Corps Warfighting Publication (MCWP) 3-37, *Marine Air Ground Task Force (MAGTF) NBC Defense*.

5.3 STANDARDS OF PROFICIENCY AND CURRENCY

Each service establishes standards of proficiency and currency for NBC defense training. The following sections describe of each Service's activities for NBC defense training.

5.3.1 Army

Army Regulation 350-41, *Training in Units*, establishes Army standards for proficiency for NBC defense training. NBC defense training is conducted at schools and in units. The USACMLS is responsible to train and sustain Chemical Corps soldiers and leaders and provide task/condition/standard limits, suggested training products, and oversight in the areas of NBC

matters. Although the USACMLS is neither designated nor resourced to be the DoD Executive Agent for joint NBC defense training, it is pursuing the following initiatives to the extent available resources allow:

- (1) assisting CINCs, Major Commands, and their staffs in assessing and providing reference materials regarding the NBC threat and recommending actions to reduce the NBC threat in their areas of operations;
- (2) providing broad-based joint NBC defense doctrine and joint doctrine development support;
- (3) introducing and upgrading instructional aids and training support material for war colleges and command and staff colleges for all Services;
- (4) developing, evaluating, and fielding advanced instructional capabilities for both resident and nonresident instruction; and
- (5) conducting the Joint Senior Leader Training Course – A Focus on Weapons of Mass Destruction, intended to provide leaders from all Services with an understanding of joint NBC defense operations, training, readiness, threat, doctrine, and capabilities.

Individual Training. At the initial training level, NBC defense tasks are taught to students wearing Mission Oriented Protective Posture (MOPP) gear during Basic Soldier Training and Warrant Officer Candidate Training to satisfy Initial Entry Training Requirements. Common core qualification is achieved from NBC tasks training during Officer (basic and advanced) and Warrant Officer (basic) training. NCOs train on leader NBC skills during their NCO development courses. Other Officer and NCO courses require training in NBC as a condition that effects the performance of branch specific tasks. At the company level each unit has an NBC NCO specialist and at the battalion or higher level most units have an NBC Officer and Senior NCO.

Unit Training. The Army is constantly challenged to improve its training of NBC battlefield hazards by integrating such training into unit mission training as well as individual and leader training. It is required that the NBC protective mask be worn during weapons qualification training at least twice a year, depending on the unit category within the Standards in Training Commission (STRAC). Additionally, essential Army civilians are trained in NBC survival skills. Because of today's battlefield complexities, the Army takes a systems approach to its training. NBC tasks for individuals are published in Soldiers' Training Publications and trained in the Army School System. Sustainment training occurs in the unit. NBC collective tasks are published in Army Training and Exercise Plan (ARTEP) Mission Training Plans. The highest level of NBC training recognizes NBC as a battlefield condition and units train to execute their Mission-Essential Task List (METL) while under NBC conditions.

The Move of the U.S. Army Chemical School (USACMLS). The USACMLS moved to Fort Leonard Wood, Missouri, following closure of the base at Fort McClellan, Alabama, where it had been located previously. Construction was completed and was occupied by the Chemical School in accordance with the schedule shown:

Facility	Construction Completion	Available for Occupancy
CDTF* Admin Building	30 September 1998	15 November 1998
CDTF Training Building	7 January 1999	12 February 1999
Chemical Applied Training Facility	13 October 1998	8 January 1999
General Instruction Facility	17 May 1999	21 July 1999
Unaccompanied Enlisted Housing	17 May 1999	2 July 1999

*Chemical Defense Training Facility

In preparation for the move, the first individuals departed Fort McClellan in October 1998 and were assigned to the CDTF at Fort Leonard Wood. A second large group left during February through March 1999. These include the combat developers, the training developers, and portions of the Chemical Brigade staff. The training departments moved to Fort Leonard Wood during May to August 1999 upon completion of scheduled training at Fort McClellan.

The USACMLS activated the 3d Chemical Brigade at Fort Leonard Wood on 20 August 1999. This brigade is responsible for all training activities at the Chemical School. This brigade also will provide command and control for the 82d Chemical Battalion (OSUT), the 84th Chemical Battalion, and the 58th Transportation Battalion, the Chemical Defense Training Facility, and the International Student Detachment.

The 3rd Chemical Brigade began its first training of OSUT on 2 July 1999 and proceeds today. The first Professional Development course began on 16 August 1999. Although there have been many challenges, training the force to standard at the new installation continues. The Brigade executed the first Toxic Agent Training at the CDTF on 21 September 1999 with installation Senior Leadership. The first class of students trained in the CDTF beginning 4 October 1999. Smoke training for students will commence in accordance with the comprehensive plan that will ensure compliance with Federal and State environmental regulations pertaining to smoke training on Fort Leonard Wood.

Medical Training. The U.S. Army funded medical NBC defense training that was conducted by the U.S. Army Medical Department Center and School (AMEDDC&S), the U.S. Army Medical Research Institute of Chemical Defense (USAMRICD), the U.S. Army Medical Research Institute of Infectious Diseases (USAMRIID) and the Armed Forces Radiobiology Research Institute (AFRRI). Courses were offered at the training center, at the requesting unit's site, and via distance education courses. In-house training, especially for the courses offered at USAMRIID and USAMRICD, enables students to use the extensive laboratory and field training facilities available at these commands. On-site training, *i.e.*, courses taken "on the road" and presented at military installations worldwide, minimizes student travel costs while preserving direct instructor-student interactions. Distance learning programs minimize training costs and increases the student audience size. During FY99, over 45,000 Army, Navy, Marine, Air Force, DoD civilian, non-DoD, and non-US personnel received some form of Medical NBC training via these courses.

The AMEDDC&S trains U.S. Army Medical Department (AMEDD) specialists and leaders with courses offered in-house at Fort Sam Houston, Texas. Initial Entry Training (IET) for AMEDD soldiers includes Medical NBC subjects appropriate for each specialty. This year,

over 3,000 combat medics received instruction in treating and decontaminating biological and chemical casualties and over 150 Food Inspection Technicians received training on food management in an NBC environment.

All new AMEDD officers received 39 hours of NBC classroom instruction and 12 hours of NBC field training during their Officer Basic Course (OBC). The OBC teaches the fundamental knowledge and skills necessary to conduct medical operations in an NBC environment, control NBC contamination in medical units, and understand the medical implication of NBC exposures, including battlefield Low-Level Radiological (LLR) hazards. In FY99, 8 OBC courses graduated 1,230 officers, including 457 USAR, 150 ARNG and 10 non-US officers.

Advanced officer training (OAC) includes 10 hours of medical NBC correspondence courses. For students who have not completed the "Medical Management of Chemical and Biological Casualties Course" (MCBC), the USAMRIID and USAMRICD presented the 3-day on-site version of the MCBC during the OACs at the AMEDDC&S. In FY99, 711 U.S. and 28 foreign officers attending the OAC. The foreign officers received an additional 40 hours of Medical NBC training. Sixteen U.S. Army officers received additional NBC instruction during the Brigade Surgeon Course.

In preparation for the rank of staff sergeant, Army combat medics attend the Basic NCO Course (BNCOC) of the AMEDDC&S. BNCOC includes classes and practical exercises in battlefield medical operations in an NBC environment, decontaminating, managing and treating contaminated casualties, and training non-medical soldiers in casualty decontamination procedures. In FY99, more than 1,267 NCOs attended BNOCC, including 7 USAR, 7 ARNG and 7 non-US students.

Low Level Radiological (LLR) training was presented by the AMEDDC&S during the Health Physics Specialists course, and to selected Army Nuclear Medical Science Officers (NMSOs). NMSOs fill field Medical NBC Defense Officer positions. LLR training enables NMSOs and health physics specialists to advise, and provide technical support, to units confronting Radiological Dispersal Devices (RDDs) or the accidental or malicious release of radioactive materials from nuclear facilities or storage sites. In FY99, 28 NCOs completed the 12-week Health Physics Specialists Course, and 4 NMSOs receive 40 hours of LLR training while attending other AMEDDC&S courses.

USAMRICD trained 187 Army, 20 Navy/Marine, 1 Air Force and 21 non-DoD personnel with the AMEDDC&S sponsored "Field Management of Chemical and Biological Casualties Course" (FCBC). The MCBC trains personnel in the first echelon management of chemical and biological agent casualties. Presented as a five-day in-house course at Aberdeen Proving Grounds, the FCBC is also offered as a three-day on-site course. The FCBC's classroom discussions include: the current global threat of chemical and biological agent use, the characteristics and effects of threat agents, recognition and emergency treatment of agent exposure, principles of triage and decontamination of chemical and biological agent casualties. During FY99, USAMRICD presented the FCBC five times in-house, once on-site, and once as a VTC course.

Thirty preventive medicine officers and other medical professionals assigned to deployable units, or directly responsible for NBC consequence management, attended the tri-Service “Medical NBC Readiness Workshop” of AMEDDC&S. Sponsored by the U.S. Army Office of the Surgeon General, this course provides instruction in the medical management the full spectrum of possible NBC threats, from battlefield NBC scenarios to the conduct of peacetime operations in areas deliberately contaminated with radioactive materials or industrial chemicals.

USAMRICD trained 1,574 Army, 242 Navy/Marine, 455 Air Force, 96 non-DoD and 8 non-US medical professionals with the “Medical Management of Chemical and Biological Casualties Course” (MCBC). Sponsored by the AMEDDC&S, the students attending the in-house MCBC divide their time between USAMRIID at Ft. Detrick, Maryland and USAMRICD at Aberdeen Proving Grounds, Maryland. The MCBC provides DoD personnel, primarily physicians, physician assistants, and nurses, with a working knowledge of the potential threat of chemical and biological weapons and the status and scope of medical defense strategies. It combines classroom instruction and field experience to establish essential skills, instill confidence, and define limitations in therapeutic modalities with each type of medical setting. The course also provides instruction on the use of specialized equipment and skills required for safe, long distance evacuation. First-hand experience in triage, decontamination, and medical operations on the integrated battlefield is stressed. The in-house MCBC course, which has doubled in size from 70 to 140 students per course, was offered four times this year. The off-site MCBC, presented 24 times during the fiscal year, is in the process of conversion into a distance learning course.

USAMRICD and the AMEDDC&S presented training to the 10 National Guard Weapons of Mass Destruction Civil Support Teams (WMD-CST) teams established this year. USAMRICD presented the MCBC course for WMD-CST members at Aberdeen Proving Grounds, Maryland. The AMEDDC&S presented a modified version of the two-week Medical NBC Readiness Workshop to the WMD-CST at the AMEDDC&S. The WMD-CST, which can be sent by the State or the Federal government to respond to a suspected or actual WMD attack, are tasked with initially assessing the situation and advising the local incident commander.

AFRRI trained 229 Army, 68 Navy/Marine, 34 Air Force, and 13 other personnel with the “Medical Effects of Ionizing Radiation” (MEIR) Course. The MEIR course, funded by the Army Office of the Surgeon General, provides up-to-date information concerning the biomedical consequences of radiation exposure, how the effects can be reduced, and the medical management of radiological casualties. The MEIR course, sponsored by the AMEDDC&S, is presented in-house at Bethesda, Maryland, and on-site at US military installations worldwide. The course has been expanded to include non-nuclear weapon radiological hazards, such as Low Level Radiological (LLR) hazards, which could be encountered on the battlefield or during non-combat military operations.

The Army Office of the Surgeon General funded USAMRIID and USAMRICD initiatives to exploit the potential of medical NBC distance learning courses. Distance learning courses, using VTC, satellite broadcasting, videotape series and computer based training pro-

grams, offers an alternative for those otherwise unable to attend training. The “Biological Warfare and Terrorism: the Military and Public Health Response” VTC course cost only \$52.93 per student, a fraction of the estimated \$1,000/student to present the course in-house. The convenience of distance learning also enables large numbers of medical professionals to attend training.

In FY98, U.S. Army Medical Research Institute of Infectious Diseases (USAMRIID), in collaboration with the Centers for Disease Control and Prevention, broadcast a live, interactive satellite distance learning course entitled “Medical Response to Biological Warfare and Terrorism” to 17,319 military and civilian health professionals and first responders at 500 sites across the United States. This 3-day course proved to be very cost-effective, as the cost was \$69 per student trained; whereas, it costs an estimated \$1,000 to train a health care provider at USAMRIID’s resident in-house course, which is given four times yearly to 76 students per course. This satellite distance learning course represented a new era in cooperation with a civilian government agency to provide important information to all who may confront threats from biological agents.

USAMRIID trained 18,288 medical professionals, including 1,844 Army, 2,431 Air Force, 939 Navy/Marine, and 15,377 civilians with the “Biological Warfare and Terrorism: the Military and Public Health Response” distance learning course. This three-day course provided training in the diagnosis and treatment of biological casualties in both military warfare and civilian bioterrorism scenarios. Developed in collaboration with Centers for Disease Control and Prevention (CDC) and nationally known leaders in public health, this 12-hour, fully accredited, course was broadcast live to 721 downlink sites throughout the United States, Canada, Europe, the Middle East, Central America, and the Pacific Rim. A subsequent weekend re-broadcast of the taped course was targeted to U.S. Reserve and National Guard medical personnel.

USAMRICD provided the distance learning course “Medical Response to Chemical Warfare and Terrorism.” This course provides training in the diagnosis and treatment of chemical casualties in both military warfare and civilian bioterrorism scenarios (see USAMRICD’s Internet Web page at: <http://ccc.apgea.army.mil>). This 12-hour course is fully accredited and was developed and presented in collaboration with the Food and Drug Administration (FDA). It was broadcast live to approximately 800 down-link sites in all 50 States, Canada, Germany, Hong Kong, Iceland, Italy, Japan, Portugal, Republic of Singapore, South Korea, and Spain. The estimated viewing audience was 2.5 million people. A subsequent weekend re-broadcast of the taped course was targeted to U.S. Reserve and National Guard medical personnel.

The Army Office of the Surgeon General sponsors medical NBC training initiatives beyond specific training courses. These initiatives include the Nuclear, Biological, and Chemical Casualty Training System (NBC CTS) developed by the AMEDDC&S, and is scheduled for fielding during FY00. NBC CTS is a computer program to augment medical NBC training by providing a multi-player training of the medical consequences of an NBC attack. During the NBC scenarios, participants allocate limited personnel and logistical assets to evaluate, triage, and treat the casualties. NBC CTS allows participants to exercise decision-making and staff

coordination skills, and suffer the cascading effects of their decisions, while refining individual skills, evaluating contingency plans, and learning current NBC doctrine.

The Army Office of the Surgeon General maintains the Medical NBC Online Information Server, an Internet web site at: <http://www.nbc-med.org/>. This searchable web site, visited over 400 times per day, presents NBC related news articles, case studies, congressional testimony, information papers, medical NBC references, training materials, and the schedule for related conferences and courses. Links are provided to AMEDDC&S, USAMRICD, USAMRIID, AFRRI, and other NBC related internet sites offering training documents and software packages. Many references and documents can be downloaded directly from the OTSG site, including the Medical Management of Biological Casualties Handbook and Medical Management of Chemical Casualties Handbook

The Field Preventive Medicine and Training Divisions of USACHPPM are currently working with U.S. Army Forces Command to assist field preventive medicine units in assessment of their existing environmental sampling and analysis capabilities and provide technical training on toxic industrial material risk assessment and radiological hazard risk assessment. This training includes orientation and training on existing Table of Organization and Equipment as well as USACHPPM provided equipment and support. USACHPPM will complete the initial FORSCOM active component assistance visits by the end of FY2000 and reserve components in FY 2001-2002.

5.3.2 Air Force

Air Force policy is to provide initial and annual refresher training to personnel in or deployable to NBC high threat areas (HTAs). The Air Force standards of proficiency are based on two international standardization agreements: NATO Standardization Agreement 2150 (NATO Standards of Proficiency for NBC Defense) and Air Standardization Coordinating Committee (ASCC) Air Standard 84/8 (Initial, Continuation and Unit NBC Standards). Both agreements are implemented through Air Force Instruction 32-4001, *Disaster Preparedness Planning and Operations*. The Air Force ensures proficiencies and currency of NBC warfare defense training through classroom training, unit level training, and exercises. NBC Defense Training (NBCDT) is required only for military personnel and emergency essential civilians in or deployable to NBC threat areas. Major Commands (MAJCOMs), the Air Reserve Component, and Direct Reporting Units may tailor their NBCDT programs to meet their specific mission requirements. The subjects presented in the classroom follow the three principles of NBC defense (avoidance, protection, and decontamination) as identified in Joint Pub 3-11. Unit level training follows the classroom training on wartime mission critical tasks. Supervisors train personnel to complete mission critical tasks while the workers are wearing their full complement of individual protective equipment. Exercises are used for training and evaluation purposes. Instructors at base level receive their professional training through Air Force courses at Fort Leonard Wood, Missouri.

Individual Training. There are two types of individual training. The first is general equipment and procedures training that enables personnel to recognize and protect themselves and others from NBC hazards. The second is individual proficiency training that enables personnel to

perform their wartime tasks in a NBC-contaminated environment. Detailed training comes with assignment to a threat area or to a deployable unit. Personnel receive the following NBC defense training courses:

AUDIENCE ^{1,2}	TYPICAL INITIAL INSTRUCTION TIME	INITIAL (FREQUENCY)	REFRESHER (FREQUENCY)	REMARKS
Low threat	6 hours	Within 90 days of assignment to mobility positions or 90 days prior to permanent change of station (PCS) to a CB high threat area.	Annual show of competency or as directed by MAJCOM.	Allow extra time for quantitative fit testing (QNFT)/ confidence exercise and CCA training.
Medium threat	6 hours	Within 90 days of arrival	Within 90 days of arrival	See Note 2
High threat	6 hours	Within 90 days prior to PCS to high threat area.	Within 30 days of arrival - topics should only include theater specific procedures and QNFT.	See Note 2

1. NBC Defense Training is required for military personnel and emergency essential civilians in or deployable to chemical-biological medium and high threat areas.
2. Initial training is required if there has been a break of 36 months or more in NBC defense training.

NBC refresher training is at the discretion of the MAJCOMs, with the majority opting for annual refresher training through classroom training and exercise participation. Individual NBC proficiency training occurs through on-the-job-training and exercise participation. In addition, aircrews are required to conduct a one-time flight while wearing chemical defensive equipment.

Unit Training. Units in or deployable to NBC threat areas must conduct the following training:

CB Threat Area	MINIMUM EXERCISE REQUIREMENTS
Low	Annually - Conduct attack response exercise implementing the base OPlan 32-1 and other contingency plans (<i>i.e.</i> , NBC, terrorist, or conventional attack). - Conduct an attack response exercise for units' mobility commitments based upon the threat at deployment locations.
Medium	Semiannually - Conduct attack response exercise implementing the base OPlan 32-1, BSP, and other contingency plans (<i>i.e.</i> , NBC, terrorist, or conventional attack). One exercise may be satisfied by a tabletop exercise. - Conduct attack response exercise for unit mobility commitments based on the threat at deployment locations. One exercise can be satisfied by a tabletop exercise.
High	Semiannually - Conduct attack response exercises implementing the base OPlan 32-1, BSP, and other contingency plans.

Air Force major commands have reported significant increases over the last three years in the number of people receiving equipment and procedures training as well as the number of hours spent for that training.

Medical Training Initiatives. Following the Air Force Medical Service (AFMS) NBC Warfare Defense Training Workshop in 1998, eleven training initiatives were prepared to meet gaps in

Air Force chemical and biological medical defense training. Training tools for the AFMS re-engineered unit type codes, such as: (1) Patient Decontamination Teams, (2) Chemically Hardened Air Transportable Hospital, (3) Preventive and Aerospace Medicine (PAM) team training, (4) Bioenvironmental Engineering NBC team training, (5) PACAF AFMEDPAC 2000, (6) Continuing Medical Readiness NBC training, (7) NBC CD-ROM Toolboxes, (8) ACC/Force Protection Battle Lab Initiative – Bio Agent detection training, and (9) NBC Defense Leadership Skills training were identified for contractor development. The Army (funded by the AF) is the office of primary responsibility for the final two initiatives: (10) Medical Management of Chemical Casualties, and (11) NBC CD-ROMs. Care providers who have not been afforded the opportunity to attend the Army MCBC Course will receive an instructor based course on medical management of chemical and biological casualties training at their units. Overseas locations have priority over CONUS bases for this initiative. In addition, identified medical UTC teams will receive medical reference materials developed by the US Army and civilian contractors for training.

5.3.3 Navy

Navy Chemical, Biological and Radiological Defense (CBR-D) training is conducted in two phases: individual and unit training. Individual training consists of attendance at formal school courses and completion of basic and advanced CBR Defense Personnel Qualification (PQS) training. Navy personnel also conduct periodic unit CBR Defense training and pre-deployment unit training exercises.

Individual Training. The Navy provides initial entry-level CBR defense training to all officers and enlisted personnel in the accession programs. Enlisted personnel receive three hours of training (two hours in the classroom; one hour in the lab) focused on the use of personal protection equipment and survival skills, including a CBR-D “confidence” chamber exposure. Officers receive two hours of class time focused on personal protection equipment and survival skills. After reporting to designated units, Navy personnel also are required to complete basic and advanced CBR-D PQS training.

Officer and Enlisted Personnel assigned to ship and shore billets requiring CBR-D expertise receive additional CBR-D related courses. These courses include the Disaster Preparedness Specialist Course and the CBR-D Operations and Training Specialist Course conducted at the U.S. Army Chemical School. Additional CBR-D training is covered in the Repair Party Leader Courses conducted at various Fleet Training Centers. Officers receive additional CBR-D related training at the Damage Control Assistant Course, the Shipboard Department Head Course, the Prospective Executive Officer Course, and the Prospective Commanding Officer Course held at the Surface Warfare Officer School, Newport, RI.

Navy medical providers attend the Management of Chemical and Biological Casualties Course at the U.S. Army Medical Research Institute for Chemical Defense, Aberdeen Proving Grounds, Maryland and the U.S. Army Medical Research Institute of Infectious Diseases, Ft. Detrick, Maryland.

Unit Training. Proficiency training is conducted at the unit level by Navy instructors who are graduates of the CBR-D Operations and Training Specialist Course conducted at the U.S. Army Chemical School. Navy units conduct basic, intermediate, and advanced training exercises as part of the Training and Readiness Cycle prior to deployment. During the basic training phase, CBR-D training exercises are overseen by the appropriate Type Commander and may involve additional unit training by CBR-D specialists from an Afloat Training Group (ATG). During the intermediate and advanced phases of the training cycle, combat readiness is reinforced through Composite Training Unit Exercises and Fleet Exercises.

5.3.4 Marine Corps

The Marine Corps' NBC training focuses on the ability to conduct operations throughout the battlespace with particular emphasis on amphibious deployment, littoral, and air/ground operations. The Marine Corps views NBC as an environment, similar to daylight/darkness and cold/heat, yet with its own unique challenges.

Training requirements are derived from the Force Commander's Mission Essential Task Lists, Joint Universal Lessons Learned, Marine Corps Lessons Learned, Mission Need Statements, and Fleet Operational Needs Statements. Once validated, the training requirements are introduced into the Systems Approach to Training (SAT) Process. One of the results of the SAT process is the development of training tasks and standards that will fulfill the training requirements. These task lists and standards are incorporated into Individual Training Standards (ITSs) for individual Marines and Mission Performance Standards (MPS) for Marine units. These ITSs and MPSs are published as Marine Corps Orders for standardization and compliance throughout the Marine Corps.

The Marine Corps conduct training in two categories: Individual Training based on ITSs and Collective (unit) Training based on MPSs. Figure 5-1 shows the individual NBC training provided to all Marines.

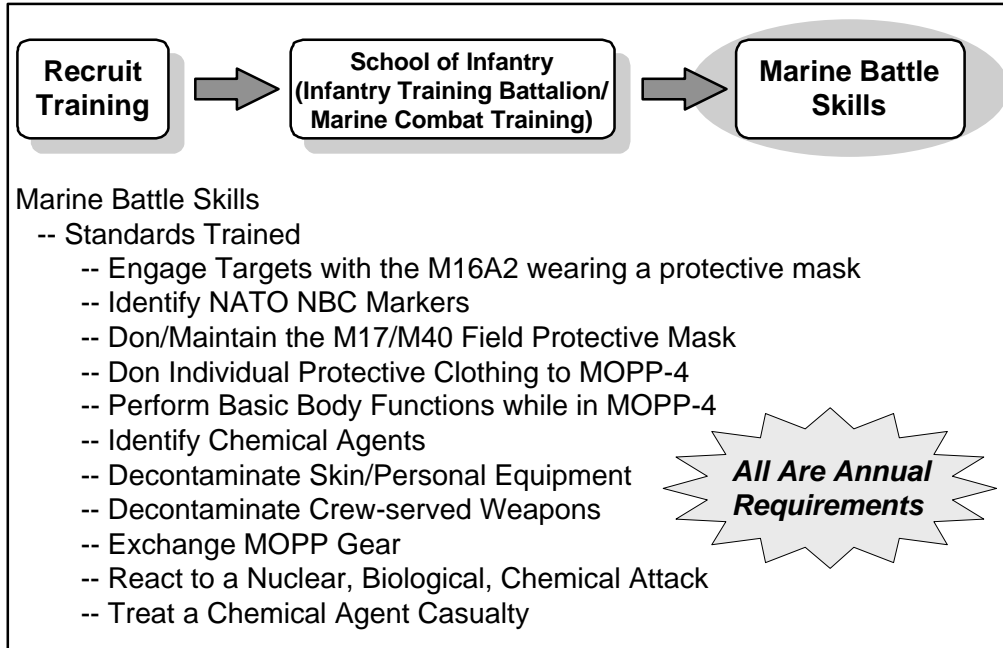

Figure 5-1. USMC Individual NBC Training

Individual Training. Enlisted Marine entry level training begins at recruit training or “Boot Camp” where Marines are introduced to the field protective mask and the gas chamber. All enlisted Marines then proceed to the School of Infantry (SOI). The training focus is surviving and functioning in an NBC environment. Training transitions from a classroom/academic environment to practical application/field environment to provide students more hands-on experience.

Once Marines reach their units they begin the Marine Battle Skills Training program. Marine Battle Skills is a set of tasks which all Marines are required to be proficient in and are evaluated annually. Marine Battle Skills NBC training focuses on providing Marines the capability to survive as well as function in an NBC environment.

Unit Training. Unit level (or collective) training includes classroom and field training and is included in unit training exercises and plans. (See figure 5-2.) Units are also required to meet very specific training standards. These requirements take the form of Mission Performance Standards (MPSs). Each type of unit in the Marine Corps has a set of MPSs assigned to it. These MPSs are published as 3500 Series Marine Corps Orders.

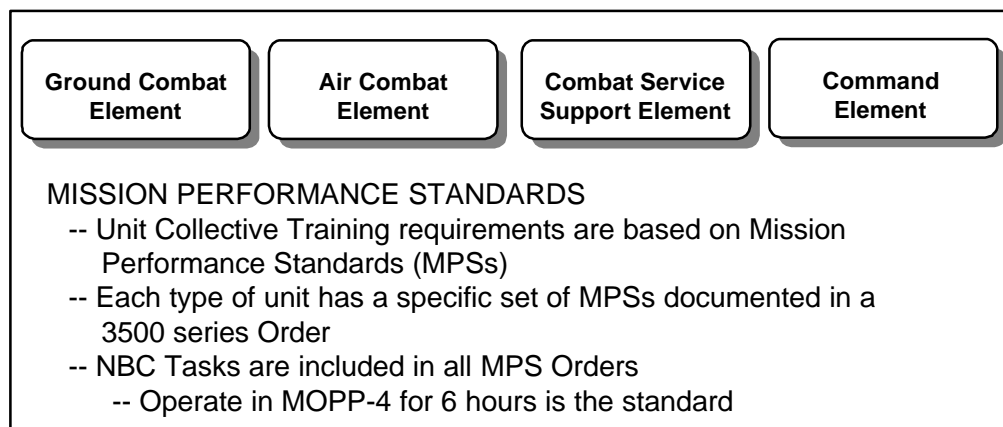

Figure 5-2. USMC Collective Training, NBC Requirements

Each MPS Order includes NBC Tasks which the unit must accomplish. However, each set of requirements varies from unit to unit. For example, a Tank Battalion must be able to utilize the vehicle's NBC filtration system, decontaminate tanks, and operate tanks under NBC conditions. An Infantry Battalion on the other hand has no requirement to decontaminate tanks, but does have to decontaminate crew served weapons. NBC evaluations are conducted annually for all Marine Corps units. Those units that are part of the Marine Corps' Unit Deployment Program (UDP) and designated Marine Expeditionary Units (MEUs) are required to undergo an NBC evaluation prior to deployment.

5.4 NBC DEFENSE PROFESSIONAL TRAINING

Public Law 103-160 requires all Services to conduct NBC defense professional training at the same location. Currently, all Service training is co-located at the United States Army Chemical School at Ft. Leonard Wood, Missouri. Each Service conducts their training with their own Service instructors. The experts who graduate from the Service's technical training and the Army's Chemical Defense Training Facility become instructors for their Service's unit training. The Defense Weapons School attached to the Field Command, Defense Threat Reduction Agency (DTRA) at Kirtland AFB, New Mexico, conducts a nuclear hazards training course: *e.g.*, Technical Escort Course and the Radiation Safety Officer Course.

5.4.1 Joint NBC Defense Professional Training

The JSIG has established Joint Assessment Working Group (JAWG) comprised of Service detachment representatives at the USACMLS to discuss issues pertaining to facilities and range scheduling and any other training issues that impact the ability of the Services to conduct effective professional training.

Information exchanges between the Services were facilitated by the JSIG and plans put in place to review future doctrine and new equipment training plans. Discussion concerning a Joint instructor pool was shelved due to unique training requirements each Service possesses. The Army plans to consolidate common and shared (Chemical, Military Police, and Engineer) training.

Joint Professional Military Education, Phases I and II, currently contains no NBC defense considerations or requirements. It is essential that officers of all Services assigned to joint staffs understand the NBC threat, are familiar with U.S. capabilities to detect and mitigate the threat, and comprehend their staff roles and responsibilities in dealing with NBC issues. The JSIG, along with the Services, Joint Staff, and CINCs will address these important shortfalls and requirements in the coming year.

Within the joint medical arena, the US Army Medical Department sponsors the Medical Management of Chemical and Biological Casualties (MCBC) course, which provides training to DoD personnel. Additional information on this course can be found in Section 5.3.1. Based on guidance contained in DoD Directive 6025.3, *Clinical Quality Management Program in the Military Health Services* (signed 20 July 1995), health care providers are directed to receive certification for assignments during military operations. This certification includes NBC defense training and provider courses where applicable. The medical commander will review certification annually. In addition, on 20 December 1995 the DoD completed DoD Instruction 1322.24, *Military Medical Readiness Skill Training*, which implements policy, assigns responsibility, and prescribes procedures for developing and sustaining comprehensive systems for providing, assessing, and monitoring military medical skills training essential for all military personnel, health care personnel, and medical units. NBC defense training, to include chemical and biological warfare defense measures and medical specialty training such as casualty management, are specifically articulated in the instruction.

All Medical Nuclear Casualty Training has been consolidated under the Armed Forces Radiobiology Research Institute in Bethesda, Maryland, where radiobiology education is made available in a Tri-Service format.

5.4.2 Army NBC Defense Professional Training

U.S. Army NBC Defense Professional Training presently takes place at Fort Leonard Wood, Missouri. Training consists of three enlisted/noncommissioned officer courses and two officer courses. At initial entry One Station Unit Training, enlisted soldiers receive training in chemical and biological agent characteristics and hazards, smoke and decontamination operations, chemical and radiological survey procedures, and individual protective clothing and equipment. This program provides 19 weeks of intensive training, culminating in live/toxic agent training in the Chemical Defense Training Facility. Toxic agent training is an integral, mandatory component of all Chemical Corps initial entry and professional courses.

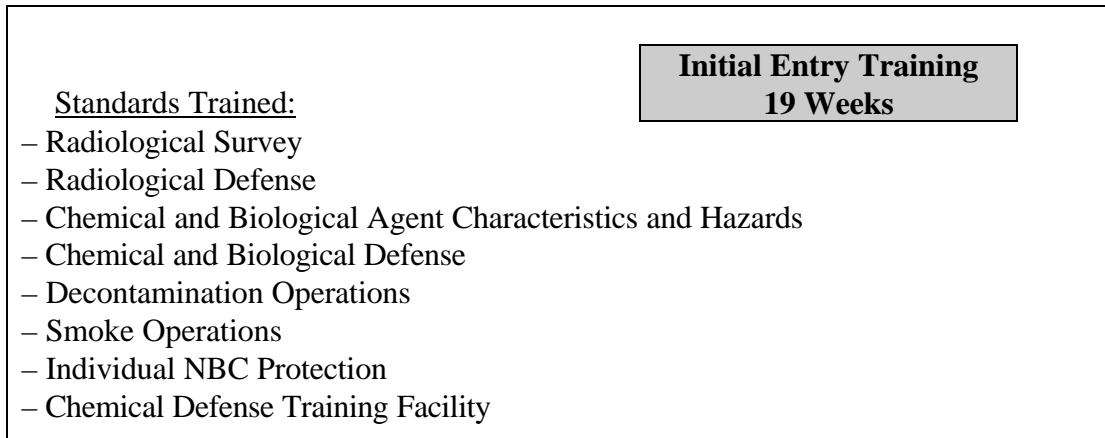

Figure 5-3. U.S. Army Initial Entry Training

Chemical Corps sergeants attend the 15 week Chemical Basic Noncommissioned Officer Course (BNCOC) where they are trained to be an NBC company squad leader and a non-chemical company or battalion NBC NCO. Chemical BNCOC provides the NCO with the technical and tactical skills needed to advise company/battalion commanders in NBC operations and procedures, to train non-chemical soldiers in NBC avoidance, decontamination, and protective measures and to lead smoke/decontamination squads.

Chemical Corps staff sergeants and sergeants first class attend the 13 week Chemical Advanced NCO Course (ANCOC) where they are trained to be an NBC platoon sergeant, an NBC NCO at brigade level, and an NBC NCO in a division or Corps level NBC element. During training they receive advanced technical operations, hazard estimates, logistics and maintenance management, combined arms operations, smoke and flame support, and training management.

Chemical Corps lieutenants attend a 19-week officer basic course, 10-weeks during mobilization. Reserve Component officers must attend the resident course. The Maneuver Support Center (MANSCEN), will instruct the 3-weeks of common lieutenant training from the Chemical, Engineer, and Military Police schools. The Chemical Officer Basic Course (COBC) prepares lieutenants to serve as a Chemical Corps platoon leader or as a non-chemical battalion chemical staff officer/assistant operations officer. This course provides them with a fundamental knowledge of NBC agent characteristics and hazards, NBC recon (non-FOX), decon, and smoke operations, NBC staff functions and NBC defensive planning, individual and unit tactical operations, and biological detection operations. This course includes classroom instruction, hands-on equipment training, and field exercises. Completion of live/toxic agent training is a prerequisite for graduation.

Chemical Corps captains attend the Captain's Career Course, an 18-week officer advanced course, in which they are trained to serve as the commander of a Chemical Company and as NBC staff officers at the brigade and division level. Instruction focuses on leadership, Army operations, smoke and flame operations in support of maneuver units, biological detection operations and NBC defensive planning to include: hazard prediction, NBC reconnaissance and decontamination operations. Additionally, officers receive training in chemical and biological vulnerability analysis, nuclear target analysis/vulnerability analysis, operational radiological

safety, and environmental management. Extensive use is made of computer simulations to reinforce the application of NBC assets in support of tactical operations. In the MANSCEN configuration, the Chemical Officer shares training with Military Police and Engineer Officers in Common Training, Shared Tactical Training, and Brigade Battle Simulation Exercise (BBS).

<p><u>Standards Trained:</u></p> <ul style="list-style-type: none"> - Leadership - Army Operations - Plan and Conduct NBC Reconnaissance - Decontamination Operations - Chemical and Biological Agent Detection Operations - Smoke and Flame Operations - Nuclear, Biological, and Chemical Target Analysis/Vulnerability Analysis - Chemical Defense Training Facility 	<div style="border: 1px solid black; padding: 5px; background-color: #e0e0e0;"> <p>Officer Advanced Course Training 18 Weeks</p> </div>
---	--

Figure 5-4. U.S. Army Captain’s Career Course Officer Advanced Training

Specialized professional training is conducted in stand-alone courses attended by DoD, Allied, and international students. These courses include:

NBC Reconnaissance Operations (FOX)	(5 weeks)
Radiological Safety (Installation level)	(3 weeks)
Operational Radiation Safety	(1 week)
Chemical Weapons Inspector/Escort (DTRA)	(1 week)
Chemical Weapons Convention Module II	(6 weeks)
Decon Procedures (Non-US) (GE, UK, NE)	(1 week)
RADIAC Calibrator Custodian	(1 week)
Biological Detection Specialist (BIDS)	(5 weeks)
Master Fox Scout	(2 weeks)
Long Range Biological Standoff Detection	(2 weeks)

5.4.3 Air Force NBC Defense Professional Training

The Air Force training detachment at Ft. McClellan offers six separate in-residence courses designed to enhance the NBC proficiency of primary-duty AF Civil Engineer Readiness Flight personnel. These courses fulfill the differing needs of the total force, including Active Duty, Air National Guard, and Air Force Reserve. Further, the Air Force administers a career development correspondence course and two mobile courses in airbase operability and NBC cell operations.

Each course contains a wide range of materials covering critical aspects of Readiness Flight operations in situations ranging from peacetime, military operations other than war, through wartime. The following is a synopsis of the NBC aspects of these courses.

Training for personnel being assigned primary readiness duties includes comprehensive coverage of agent characteristics and hazards (to include determination of incapacitation/ lethality levels); nuclear weapons effects and other specific hazards associated with ionizing radiation; NBC detection and decontamination; contamination control and avoidance techniques; plotting and reporting procedures; detailed NBC persistency and duration of hazard calculations; the inter-relationship between NBC defense and other passive defense activities (*e.g.*, camouflage, concealment, and deception, (CCD), dispersal, and hardening, *etc.*); and systematic analysis procedures for assessing the hazard and providing credible advice to commanders.

Air Force learning theory emphasizes hands-on training, and the school makes extensive use of available training ranges and equipment. The school includes Chemical Defense Training Facility (CDTF) live agent training in five of six in-residence courses. Training is provided on every major piece of equipment available in the field today, including state-of-the-art items currently being fielded.

The CE Readiness Flight Officer and 7-level Craftsman courses provide flight leaders and mid-level NCOs with the background and technical information that is necessary for effective management of the CE Readiness Flight and contingency response operations.

Readiness is the key to successful Air Force operations. Consequently, the various aspects of CE Readiness Flight operations, including NBC defense, are also topics of instruction at briefings for Air War College, Air Force Institute of Technology, or Joint Senior Leaders Course.

The School of Aerospace Medicine at Brooks AFB teaches a variety of readiness courses to medical personnel. Courses—such as Bioenvironmental Engineering, NBC Battlefield Nursing, Preventive and Aerospace Medicine contingency training, Global Medicine, Military Tropical medicine, Medical Survival training, plus many others—are provided at the San Antonio, TX base.

5.4.4 Navy CBR Defense Professional Training

The Navy Construction Training Center Detachment at the U.S. Army Chemical School offers two courses of instruction for Navy CBR-D specialists. The courses are open to Navy, Coast Guard, Military Sealift Command, and select foreign military personnel, E-5 and above. Courses are designed to provide both afloat and ashore commands with individuals who can successfully perform their requisite duties in a CBR contaminated environment. In addition, the training enables CBR-D specialists to act as the primary CBR-D trainers for their respective commands.

The training capitalizes on the unique capabilities of the Army Chemical School. Approximately 200 students graduate annually from the Detachment's courses. In addition to

being fully qualified to conduct training using the Army’s facilities, the Navy Detachment actively participates as part of the JAWG.

In addition to CBR-D Specialist courses conducted at the US Army Chemical School, the Navy has incorporated CBR-D readiness training into courses that are attended by personnel at all levels of professional development.

<u>Course Name</u>	<u>Course Location</u>
Recruit Training CBR-D	Naval Training Center Great Lakes, IL
Damage Control “A” School	Naval Training Center Great Lakes, IL
Senior Enlisted Damage Control	Fleet Training Center San Diego, CA
Hospital Corpsman “A” School	Naval Training Center Great Lakes, IL
Independent Duty Corpsman	Naval School of Health Sciences San Diego, CA and Naval School of Health Sciences Portsmouth, VA
Management of Chemical Casualties	U.S. Army Medical Research Institute for Chemical Defense, Aberdeen Proving Ground, MD
Medical Affects of Ionizing Radiation	Armed Forces Radiobiology Research Institute Bethesda,MD
Radiation Health Indoctrination	Naval Undersea Medical Institute Groton, CT
Radiation Health Officer	Naval Undersea Medical Institute Groton, CT
CBR-D Command Center	Naval Construction Training Center Gulfport, MS
CBR-D Personnel Protection	Naval Construction Training Center Gulfport, MS
CBR-D Team Training	Naval Construction Training Center Gulfport, MS and Naval Construction Training Center Port Hueneme, CA
Repair Party Leader	Fleet Training Center San Diego, CA Norfolk, VA Mayport, FL Ingleside, TX Pearl Harbor HI Yokosuka, Japan
Repair Party Officer Short Course	Surface Warfare Officers School Newport, RI
Division Officer	Surface Warfare Officers School Newport, RI
Damage Control Assistant	Surface Warfare Officers School Newport, RI
Department Head	Surface Warfare Officers School Newport, RI
Executive Officer	Surface Warfare Officers School Newport, RI
Commanding Officer	Surface Warfare Officers School Newport, RI

5.4.5 Marine Corps NBC Defense Professional Training

The Marine Corps NBC Defense School at Ft. McClellan consists of an Enlisted Basic NBC Defense Course, and an Officer Basic NBC Defense Course. In addition to the courses conducted by the Marine Corps NBC Defense School, Marines attend three other functional courses (Chemical Officer Advanced Course, NBC Reconnaissance Course, and the Radiological Safety Officer Course) conducted by the Army Chemical School.

The USMC Enlisted Basic NBC Defense Course trains approximately 200 NBC specialists in a comprehensive 10 week program covering all the ITSs specified in MCO 1510.71. The curriculum includes 108 hours of instruction on how to conduct NBC training. This training provides Marines with the tools they will need on a daily basis as they perform their

primary peacetime mission of conducting NBC Defense training to their units. The course is divided into six blocks of instruction as shown in Figure 5-5.

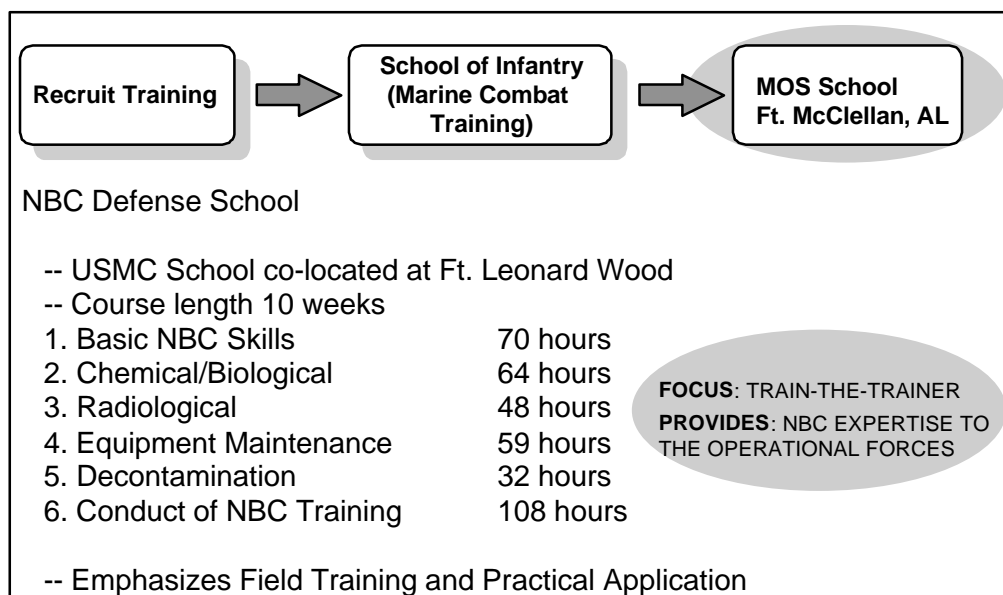

Figure 5-5. USMC Individual Training (Enlisted NBC Specialists)

Training For NBC Officers. Establishment of a Marine Corps Basic NBC Officer Course is complete. This course, shown in Figure 5-6, provides the requisite NBC skills to newly selected Marine Corps NBC Defense Officers. The first course began in June 1997. All Marine NBC Officers are Warrant Officers, usually selected from NBC Defense specialist enlisted ranks. As Warrant Officers, they focus entirely on technical expertise, NBC defense training, and supervision of enlisted NBC defense specialists. The NBC Defense Officers Course focuses on Warrant Officers and builds on previous training received. NBC Officers also attend the Army's Chemical Officer Advanced Course and Joint NBC courses as part of advanced Military Occupational Specialist (MOS) training.

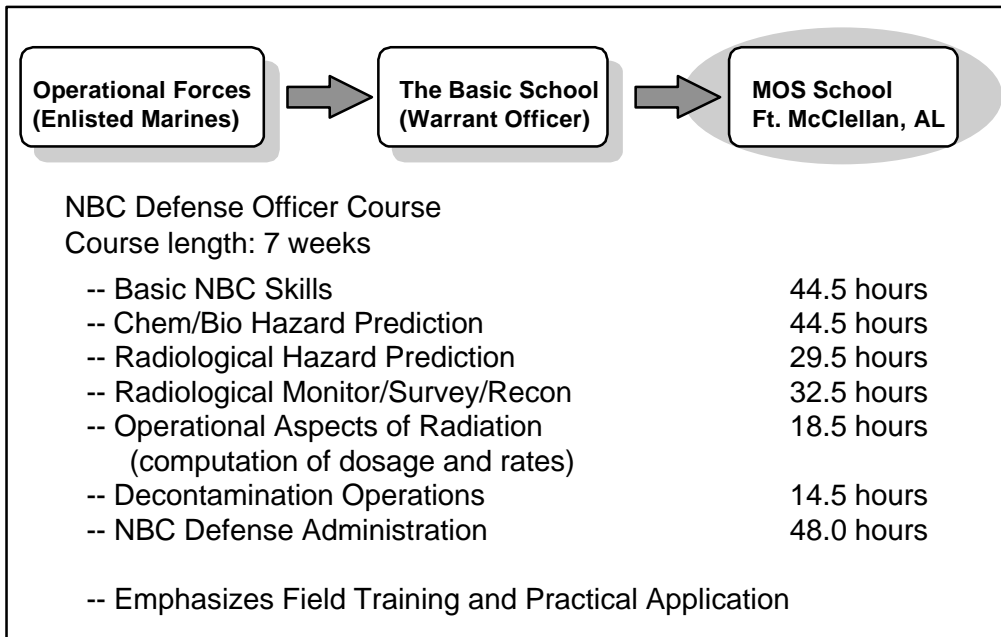

Figure 5-6. USMC Individual Training (Training for NBC Officers)

5.5 TRAINING IN A TOXIC CHEMICAL ENVIRONMENT

In 1987 the Army established the Chemical Defense Training Facility (CDTF) at Fort McClellan, Alabama. In October 1999, the Chemical School started training students at its new facility at Fort Leonard Wood, Missouri. The CDTF trains military and civilian personnel in a toxic chemical environment. Since its opening, the Army has used this valuable resource to train over 51,000 U.S. and Allied military personnel as well as selected DoD civilians. The CDTF promotes readiness by providing realistic training in the areas of detection, identification, and decontamination of chemical agents. The training develops confidence in chemical defense tactics, techniques, procedures, and chemical defense equipment. Instructors ensure that trainees can adequately perform selected tasks on a chemically contaminated battlefield. To date, the CDTF has maintained a perfect safety and environmental record.

Enrollment at the Joint Senior Leaders Course and the Toxic Agent Leader Training Course at Ft. Leonard Wood, Missouri continues to be in demand. Over 2,000 active and reserve commanders, service leaders, and toxic agent handlers from each of the services have attended. These personnel become very familiar with NBC considerations. Additionally, toxic chemical environment training provides senior officers, commanders, and future NBC defense specialists confidence in their doctrine, warfighting techniques, and the equipment they fight with in the face of challenges presented by NBC contamination.

The Weapons of Mass Destruction Civil Support Teams (WMD-CST) will begin training at the Fort Leonard Wood facility. The facility has the flexibility to design toxic chemical agent training to prepare the WMD-CST for this unique mission — assisting civil authorities facing the threat of domestic terrorism involving weapons of mass destruction.

There is growing international interest in CDTF training participation. Germany has been taking advantage of this training opportunity for about six years. The United Kingdom now uses this facility for training.

Finally, Federal and state law enforcement agencies and other first responder-type agencies have also participated in the training. The Chemical School continues to support requests from civil authorities for toxic chemical agent training.

5.6 INTEGRATION OF REALISM/WARGAMES/EXERCISES

5.6.1 Simulations and Wargames

There are three types of simulations: live, constructive and virtual. Simulations may also be sub-grouped as training or analytic simulations.

Live simulations involve real people operating real systems. Such simulations are also known as exercises and are discussed further in the next section.

Constructive simulations allow battles to be waged on a synthetic battlefield. They are designed to give commanders and their staffs the opportunity to make decisions during a course of a battle, adjust plans to react to enemy movements, synchronize all available assets and learn, through the After Action Review (AAR) process.

Virtual simulations are designed for training and analysis primarily at the tactical level of war. These simulations are “mock-ups” of actual vehicles and give units an opportunity to train on necessary individual, crew and collective tasks without having to maneuver actual equipment in the field. While the crews maneuver their equipment around the battlefield, the rest of the environment is generated through the use of Semi-Automated Forces (SAF). SAF are computer images which replicate adjacent elements, the enemy, and the environments upon which the battle is waged.

There are over 750 virtual and constructive models and simulations in the Army community alone. Table 5-1 lists the primary battle command simulations in current use throughout the Army and their baseline ability to use NBC events in their scenarios. However, characterization of NBC effects in these models and simulations is limited. Very few combat simulations incorporate the effects of NBC, and none incorporate all aspects.

Table 5-1. Nuclear (N), Biological (B), Chemical (C), or Radiological (R) Capability In Current Constructive Simulations

NAME	USE	FIDELITY	N	B	C	R
Corps Battle Simulation (CBS)	Training	Operational	X		X	X
SPECTRUM	Training	Operational				
Brigade Battle Simulation (BBS)	Training	Tactical	X		X	X
Conflict Evaluation Model (CEM)	Analytic	Joint/Strategic	X	X	X	
TACWAR	Analytic	Joint/Strategic	X	X	X	
Vector In Command (VIC)	Analytic	Operational			X	
Computer Assisted Map Exercise (CAMEX)	Analytic	Operational				
EAGLE	Training	Operational				
Combined Arms and Support Task Force Evaluation Model (CASTFOREM)	Analytic	Tactical	X		X	
JANUS	Training/Analytic	Tactical			X	

Current training exercise gaming simulations have not received sufficient priority and/or funding to adequately portray and challenge commanders and staffs to apply NBC defense doctrine and leader-development training strategies to prepare their forces to maintain operational continuity and achieve mission success in an NBC and smoke/obscurant environment. To be an effective training mechanism, these simulations must challenge training audiences to understand adversaries' NBC intent and capabilities. Simulations must also allow players to visualize how NBC capabilities affect the battlespace, friendly courses of action, and operation plans. Additionally, effective simulations must allow players to apply NBC defense principles and capabilities to set conditions for mission success against NBC capable threats. Gaming simulations (Joint Simulation, Warfighter Simulation 2000, and Combined Arms Tactical Trainer) are being developed that will accurately replicate the NBC hazards and smoke conditions of future battlefields and their effects on friendly systems. These gaming simulations will enable commanders and staffs to train and develop required high order battlefield cognitive skills that will allow for full integration of enemy intent and capabilities, NBC environment effects, and friendly force capabilities while planning and executing operations.

There is currently no standardized instrumentation system (IS) that can realistically portray all facets of NBC effects during field training. The U.S. Army Chemical School is developing NBC Recon training devices for the detection and tracking of simulated NBC contamination at Combat Training Centers (CTCs) and home station training areas. Proposed training IS will retrieve, process, and calculate digital contamination data for maneuver units and will also include AAR feedback in the areas of NBC casualties, change of custody, and reaction procedures during NBC attacks and operations. This IS would provide a realistic replication of NBC contamination as portrayed on the battlefield. Resourcing will be pursued to field proposed training devices at CTCs and other locations.

In December 1998 and January 1999, the NBC M&S domain leads within the Army, working with the Modeling and Simulation Commodity Area Manager for the Joint Service Integration Group (JSIG), developed a detailed Master Plan for requirements definition and

verification, validation, and accreditation (VV&A). This team also prepared a detailed NBC M&S Investment Strategy.

In April 1999, the Army, under agreement with the JSIG, began incorporating a baseline capability into the emerging OneSAF TestBed version B simulation. This baseline capability is interoperable with high level architecture and works as an NBC environment and effects model in both constructive and virtual simulations.

The Army completed development in July 1999 of an initial operating capability virtual simulation for the M93A1 NBC Reconnaissance System. This simulation permits NBC Reconnaissance specialists to learn to operate the M93A1 system as a member of a crew and section on a virtual battlespace. In August 1999, the system was disassembled for movement to Fort Leonard Wood, Missouri. Future systems are planned to be built at Fort Hood, Texas and Fort Polk, Louisiana.

In May 1999, the Army began work on virtual simulations for the P3I BIDS system, to be installed at Fort Leonard Wood, Missouri and a portable unit to go with the 7th Chemical Company, home stationed at Fort Polk, Louisiana.

5.6.2 Joint NBC Training/Joint and Combined Exercises

Chairman of the Joint Chiefs of Staff (CJCS) Exercise Program. Joint NBC defense training objectives must be incorporated into the CJCS Exercise Program. This program includes exercises sponsored by combatant commanders and the Chairman, JCS. Three different types of exercises are:

- (1) **Positive Force (PF)** exercises are large scale Command Post Exercises that normally consider national level issues such as mobilization and deployment. During PF 98 (Mobilization) and PF 99 (Deployment), Joint Forces Command (JFCOM), in its role as the force provider, ensures that deploying units and personnel are certified as combat ready. Although an integral part of this certification procedure is determining unit, personnel, and equipment operational readiness under NBC conditions, JFCOM is not adequately staffed or organized to perform this certification.
- (2) **Positive Response (PR)** exercises normally consider strategic level nuclear issues. In addition to considering command and control of nuclear forces, these exercises deploy and backup national command and control personnel and systems annually. Capabilities of these redundant systems are equally applicable during chemical and biological scenarios as they are during nuclear scenarios, but chemical and biological scenarios are not adequately exercised.
- (3) The **No-Notice Interoperability Exercise (NIEX)** program continues to focus on our ability to interdict the proliferation of nuclear, chemical, and biological weapons. In 1995, the NIEX required the interagency process to respond to a foreign nation's request to interdict and recover three stolen nuclear weapons. National level forces were deployed in response to this crisis. The 1996 NIEX tested our nation's ability to respond to a crisis involving biological weapons. The Chairman of the Joint Chiefs' 1998

requirement for immediate action on WMD and NBC defense operations mandates integration of these topics into all futures NIEs.

Joint Vision 2010 provides the operational based templates for the evolution of our Armed Forces to meet challenges posed by an adversary's use of weapons of mass destruction. JV 2010 serves as the Doctrine, Training, Leader-development, Organization, and Material requirements (DTLOR) benchmark for Service and Unified Command visions. The NBC defense cornerstone resource for this vision of future warfighting embodies three required operational imperatives:

First, and most importantly, CJCS and Service leaders should recognize that NBC strategic and operational level of war expertise is an essential resource requirement in the Joint Warfighter Center (JWFC) and USACOM Joint Training and Analysis Center (JTASC). Success for Joint Vision 2010, a strategy centered on capabilities-based forces, requires these organizations to successfully accomplish their respective joint NBC defense doctrine, training, and leader development roles, and for USACOM to accomplish its NBC defense mission as force provider, force trainer, and force integrator. NBC expertise at all levels and from all Services is paramount.

Second, Unified Commands should staff their organization appropriately with the right expertise to meet current and future requirements to shape and respond to NBC challenges.

Third, doctrine, training, and leader-development training strategies should facilitate sophisticated battlefield visualization and situational awareness proficiency, allowing commanders and staffs to conduct service, joint, and combined operations in an NBC environment.

The Chairman of Joint Staff published Master Plan Exercise Guidance in May 1998. This guidance provides exercise objectives to the CINCs. This guidance provided specific counterproliferation objectives. NBC Defense and Force Protection were identified as the Chairman's top training issues. This guidance will influence and guide development of CINC exercises and training, which will be conducted in Fiscal Year 2000.

Army. The Army emphasizes integration of NBC defense training in unit rotations at the Combat Training Centers (CTCs). These centers include the National Training Center (NTC), Joint Readiness Training Center (JRTC), the Combat Maneuver Training Center (CMTTC), and the Battle Command Training Program (BCTP).

At the CTCs, the Army continues to see units at the company, battalion, and brigade levels unable to perform all NBC tasks to standard. Less than satisfactory performance at the CTCs is directly attributable to lack of homestation NBC training. These results clearly indicate a need for increased emphasis in educating senior leaders on how to leverage homestation training. Units that (1) have the necessary command support and equipment, (2) balance NBC within their overall training requirements, and (3) execute according to approved training plans, are able to survive and continuously operate in a simulated NBC environment. However,

increasingly constrained training resources limit NBC training to fundamentals. This often means training consists only of NBC survival and not training for continuous operations in an NBC environment.

Air Force. NBC warfare defense preparedness is an integral part of periodic Operational Readiness Inspections conducted by MAJCOM Inspectors General. Realism is injected into these scenarios using a simulated wartime environment including the use of bomb simulators, smoke, and attacking aircraft. Personnel are tasked to perform war skills while in their full complement of protective equipment. Additionally, Air Force units participate in major joint and combined exercises that incorporate realistic NBC situations. Following are examples that describe exercises incorporating NBC situations:

- ULCHI FOCUS LENS - PACAF Joint/combined command and control exercise conducted in conjunction with the Republic of Korea's national mobilization exercise
- FOAL EAGLE - PACAF Joint/combined rear area battle and special operations field training exercise.
- EFX – Air Combat Command sponsored expeditionary force projection exercise.

Navy. Due to the unique nature of Naval force deployments, CBR defense training is conducted whether platforms are operating independently or in a group. During scheduled CBR defense training periods, realism is stressed and CBR defense equipment is used extensively.

Naval units conduct basic, intermediate, and advanced training CBR-D exercises prior to deployment. During the basic training phase, CBR-D training exercises are overseen by the appropriate Type Commander and may involve additional unit training by CBR-D specialists from Afloat Training Groups (ATG). During the intermediate and advanced phases of the training cycle, combat readiness is reinforced through Composite Training Unit Exercises and Fleet Exercises.

The exercises conducted by deploying Battle Groups and Amphibious Ready Groups during pre-deployment Composite Training Unit Exercises and Fleet Exercises are designed to meet CINC training requirements for forces in the deployment area of responsibility.

These CINC requirements are also tested during exercises with deployed forces. Chemical – Biological Defense scenarios have been incorporated into major Joint/Combined Exercises and Fleet Exercises for deployed units. Some of these exercises include:

- Exercise Neon Falcon
- Exercise Desert Sailor
- Ulchi Focus lens
- Fleet Battle Experiment “Echo”
- Fleet Battle Experiment “Foxtrot”

Marine Corps. The Marine Corps incorporates NBC training into combined arms exercises at the Marine Corps Air Ground Combat Center in Twenty Nine Palms, California. Battalion level

unit exercises are also conducted during Korea and Thailand Incremental Training Programs where units deploy and exercise various tasks. Like the Air Force and Army, the Marine Corps also participated in major joint/combined exercises. Mission, threat, and task organization determine the level. During FY99, the Marine Corps incorporated NBC defense training into the following exercises:

- JTF Exercise United Endeavor
- Ulchi Focus Lens 99
- Foal Eagle
- IMEFEX
- Keystone 99
- Azure Haze
- Urban Warrior
- ChemWar 2000
- Brave Knight
- Agile Lion

It should be noted that all Marine Corps units must also conduct quarterly NBC exercises. Evaluations include operational, administrative, and logistical functional areas. These exercises incorporate realistic NBC defense training into the exercise scenario to enhance the value of the exercise.

5.7 INITIATIVES

This section provides details on a variety of joint and Service-unique initiative in support of defense readiness and training.

5.7.1 Joint

Doctrine. Initiatives in Joint NBC defense doctrine are detailed in section 5.2.

Modeling. At the request of the Deputy Assistant Secretary of Defense for Counterproliferation and Chemical and Biological Defense, DATSD(CBD), the JSIG has established a Commodity Area (CA) for CB Modeling and Simulation (M&S) and appointed the Navy to be the lead service. Unlike other commodity areas, which manage advanced development programs, the M&S CA will primarily develop joint requirements, identify funding requirements to improve training and doctrine development, and promote standardization.

To support the M&S CA, the JSIG is overseeing the development of a CB M&S Master Plan. When completed and approved, the plan will form the basis for future M&S research and development conducted by the JSIG and JSMG. Findings from the Master Plan will be used to refine the M&S portion of the Modernization Plan in FY2000.

The DATSD(CBD) initiated a study to evaluate the suitability of VLSTRACK and HPAC for operational analysis. A study advisory group has been formed to evaluate the study and recommend how to consolidate the capabilities of the two models into a single system and reduce future duplication of developmental effort.

The Counterproliferation Review Council Verification and Validation (V&V) Standards Working Group initiated a process in FY99 to standardize the V&V of CB models. This effort

should improve overall V&V activities, allow model-to-model comparisons and simplify eventual accreditation for various applications.

JCATS, JWARS and JSIMS are the future joint models for constructive and virtual combat simulation for training and analysis applications. Plans to incorporate CB defense effects into these models were initiated in FY98. VLSTRACK has been loosely coupled to JCATS to demonstrate the ability to add high resolution CW effects. The JSIG will be funding the continuation of this effort in FY99 and beyond. A contractor has been tasked by the JWARS program office to develop a plan for incorporating CB effects into JWARS.

The JSMG is sponsoring a program to develop models to evaluate effects of CB defense at APODS and SPODS.

Training.

5.7.2 Army

In an effort to refine doctrine and training, the Army is quantifying the impact of NBC environments on combat operations. Two programs have been executed to achieve this goal: (1) Combined Arms in a Nuclear/Chemical Environment (CANE), and (2) Physiological and Psychological Effects of the NBC Environment and Sustained Operations on Systems in Combat (P2NBC2). These Force Development Testing and Experimentation (FDTE) evaluations have improved our understanding of individual and unit operations and performance degradation while in MOPP. The CANE FDTE evaluations quantified field data that commanders can use for planning, training, and decision making to respond to the threat.

The Army, as proponent for CANE tests, has completed five field evaluations (mechanized infantry squad/platoon in 1983, tank company team in 1985, armor heavy battalion task force in 1988, light infantry forces in 1992, and air defense artillery in 1993). The Army has established the Chemical Vision Implementation Plan (CVIP) a systematic review process to ensure identified deficiencies are addressed and corrected. The Commandant of the Army's Chemical School reviews the CVIP annually. Army field manuals are then revised to address deficiencies identified in CANE tests.

Before CANE FDTEs were conducted, commanders' training in a simulated NBC environment had an indication of the degradation that MOPP places on their operations. They were aware that training could maximize proficiency, but they lacked the feedback to direct that training. Consequently, training was often sporadic and incomplete.

The Army is now implementing several training guidance improvements by:

- Providing heightened command emphasis to unit commanders on NBC threat with attention to Third World countries;
- Simulating NBC environments in training;
- Continuing emphasis and effort to integrate safe, realistic NBC defense in all types of training.

5.7.3 Air Force

The Air Force currently has three training and readiness initiatives underway and continues to improve its professional training.

The Civil Engineer Readiness Technical School implemented an advanced scenario-driven exercise in the CDTF revolving around a terrorism incident involving chemical munitions. This training is provided to advanced students and differs from the lock step training provided to Apprentice-level students. The scenario will be reviewed/revised annually during the respective course reviews. Air Force instructors are qualified to conduct joint classes at the CDTF and are fully integrated into CDTF operations. Readiness instructors lead Air Force students from five of six residence courses through the training and also assist the other services with their training requirements. Additionally, they provide an orientation of NBC defense concepts and live-agent training in the CDTF for key Air Force personnel during the semi-annual Joint Senior Leaders Course. The school's Specialty Training Standard requires readiness students and personnel to be highly qualified in chemical biological defense operations, including conducting and advising leaders on hazards analysis and the use of emerging detection and plotting technologies.

Air Force Readiness personnel enrolled in correspondence courses for upgrade training to the five skill level will soon be able to complete the course on interactive CD-ROM including full motion-video and sound. The course is presently available only in a paperback version, which will continue to remain available for a limited period after the CD-ROM release. Interactive courseware development began in FY97 and is expected to be completed by FY00.

The Air Force NBC Ability to Survive and Operate (ATSO) Working Group (WG) (IPT) is a cross-functional forum that identifies and tracks AF NBC defense action items. Current NBC defense training initiatives tracked by the WG include the following:

- Implement a chem-bio protective mask quantitative fit training (QNFT) program to maximize protection by ensuring personnel attain the best fit possible
- Enhance Civil Engineer Squadron Commanders Course to put more emphasis on NBC defensive operations; provide an overview of Air Force Manual (AFMAN) 32-4019, *Chemical-Biological Warfare Commander's Guide*, to include the Vulnerability Assessment Tool; and new consequence management (CM) requirements
- Enhance Air Force Group Commanders Course to include new CM requirements
- Enhance On-Scene Commanders Course to include new CM requirements
- Develop a multimedia training format for AFMAN 32-4019
- Develop AFMAN 32-4019 training for Readiness personnel
- Incorporate AFMAN 32-4019 training in Air Force SILVER FLAG training site curriculum
- Enhance AF NBC defense unit training to allow for increased emphasis on NBC defensive posture during unit training.

Additionally, the AF Medical Service has developed, or is in the process of developing, NBC Defense Training contract SOWs for eleven initiatives. Paragraph 5.3.2 lists all eleven. All are being managed by HQ AETC/SGP and HQ USAF/SGX.

5.7.4 Navy

Navy initiatives focused on improving both CB Defense Training and Doctrine across the fleet and also improving coordination of defense actions with the other services. To raise the level of CBR-D knowledge, CB Defense interactive CD-ROM trainers and videotapes were fielded to operational units.

Navy Environmental Health Units (NEHCs) in San Diego and Norfolk, VA initiated a course of instruction for the training of medical personnel in the medical management of casualties caused by chemical, biological, radiological, and environmental (CBRE) exposures.

Personnel from the Navy Warfare Development Command, Surface Warfare Officer School Command, and the Naval Construction Training Center assisted in revisions to CB Defense Doctrine, including NWP 3-20.31 *Surface Ship Survivability* and NWP 3-11.23 *Joint Doctrine for Nuclear, Biological, and Chemical (NBC) Defense Operations*. These doctrine changes were developed and tested during Joint/Combined training exercises.

The Naval Construction Training Center Detachment US Army Chemical School made a successful transition from Fort McClellan, Alabama to Fort Leonard Wood, Missouri. This transition was made without impacting Navy readiness.

5.7.5 Marine Corps

During FY99 the Marine Corps Chemical Biological Incident Response Force (CBIRF) continued to refine its tactics, techniques, and procedures to respond to the growing biological and chemical terrorist threat.

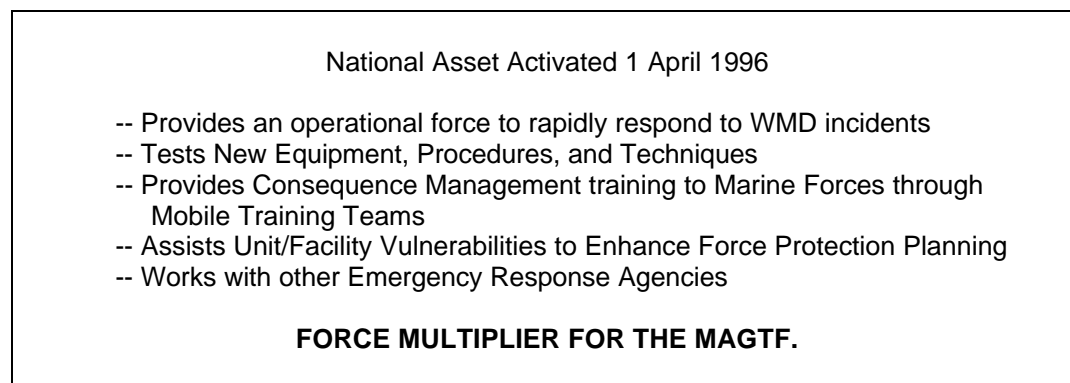

Figure 5-7. Chemical/Biological Incident Response Force (CBIRF) Role in Training

The CBIRF focuses on consequence management to terrorist-initiated NBC incidents. The CBIRF is a national asset, to be globally sourced to Marine Force Commanders and

National Command Authority for duties as the President may direct. The CBIRF consists of 360 skilled and trained Navy and Marine personnel, organized into five elements: Headquarters (including a Reach-Back Advisory Group), Security, Search and Rescue, Service Support, Force Protection (Reconnaissance/Decontamination) and Medical. The CBIRF has state-of-the-art detection, monitoring, medical and decontamination equipment and is prepared for operations in a wide range of military-civilian contingencies. In addition to the CBIRF's capabilities to respond to chem/bio incidents it serves as a training asset to the operational forces. The CBIRF will provide mobile training teams to various units to provide advanced consequence management. This will provide operational forces with the most up-to-date techniques, tactics, and procedures developed by the CBIRF. CBIRF also assists in Unit/Facilities Vulnerability Assessments to enhance force protection. The bottom line is that the CBIRF serves as a force multiplier to the MAGTF.

Marine Corps FY99 Accomplishments:

- Conducted a Marine Corps-wide Table of Equipment and Table of Organization Review.
- Participated in Joint Marine Corps and Navy shipboard decontamination exercises with 7th Fleet.
- Developed an Enhanced NBC Capability Set for MEUs.
- Developed and initiated CBIRF training packages for MEUs.
- Conducted and managed the Joint Service Mask Surveillance and Testing Program.
- Conducted USMC NBC Defense Conference during September 1999.

Marine Corps FY99 Initiatives:

- Integration of NBC defense procedures in Mission Oriented Tasks (Garrison and Field).
- Conduct USMC NBC Defense Course Content Reviews based on revised ITSs and emerging NBC equipment requirements.
- Continue development of USMC NBC Defense Staff Planning follow-on course, a training course to prepare NBC defense officers and NCOs to assist in the staff planning process.
- Establishment of combat training package for ISMs for reserve forces and follow-on forces in the event of hostilities involving an NBC threat.
- Continued Annual Joint Marine Corps and Navy shipboard decontamination exercises with 7th Fleet.
- Continue participation in a bilateral exchange program with the Republic of Korea (ROK) Chemical Corps.
- Conduct Front End Analysis for an NBC SNCO Advanced Course.
- Continue development of an "Enhanced NBC" capability for MEUs.

5.7.6 Emergency Response: Army Medical Response

The AMEDD continues to be involved in supporting DoD and federal counterterrorism initiatives and contingency operations related to NBC threat agents, mainly with elements of the Medical Research and Materiel Command (MRMC). The following offices and agencies have required AMEDD assistance: DoD SO/LIC, J4 Medical Readiness, U.S. Army Technical Escort

Unit, US Department of State, Federal Bureau of Investigation, Department of Health and Human Services, Office of Emergency Preparedness, and the U.S. Marine Corps CBIRF.

The U.S. Army published AR 525-13, *Antiterrorism Force Protection (AT/FP): Security of Personnel, Information, and Critical Resources from Asymmetric Attacks*, dated 10 September 1998. From this regulation it is assumed that U.S. Army medical treatment facilities and clinics will be called upon to provide assistance to civilian first responders if a WMD terrorist act occurs and to provide emergency room and inpatient treatment for both eligible DoD beneficiaries and civilian casualties. This regulation specifically states that the Surgeon General will:

- a) Establish policy and guidance on the management and treatment of conventional and nuclear, biological, and chemical (NBC) casualties.
- b) Coordinate emergency medical NBC response capabilities worldwide with other DoD, Joint, Federal, state, local and HN agencies.
- c) Maintain medical NBC response teams to address nuclear, biological/emerging infection, chemical accidents/incidents worldwide
- d) Provide chemical and biological analysis of biomedical samples from patients/deceased to assist in the identification of agent(s) used against U.S. personnel.
- e) Provide guidance on the vaccination and prophylaxis against biological warfare agents.

The Office of the Surgeon General is currently updating Army Regulation 40-13, *Nuclear/Chemical Accident Incident Response*, to include all medical teams which could potentially be available to support civil authorities in the event of a terrorist attack with WMD. The regulation will also include the Army policy for fixed facility medical treatment facilities in support of local domestic first responders.

The AMEDD has formed Specialty Response Teams (SRTs), which in some instances may be designated Special Medical Augmentation Response Teams (SMART). These teams provide a rapidly available asset to complement the need to cover the full spectrum of military medical response—locally, nationally, and internationally. These teams are organized by the U.S. Army Medical Command (USAMEDCOM) subordinate commands; they are not intended to supplant TOE units assigned to Forces Command or other major commands. The regional medical commands (RMCs), the United States Army Center for Health Promotion and Preventive Medicine (USACHPPM), and the US Army Medical Research and Materiel Command (USAMRMC) commanders organize SRTs using their table of distribution and allowances (TDA) assets. These teams enable the commander to field standardized modules in each of the SRT areas to meet the requirements of the mission. Members of the US Army Reserve (USAR) may be relied upon to provide a variety of functions in support of the various SRT missions. All SRTs will be capable of deploying within 18 to 24 hours of notification. The two SRTs that can support NBC are the Special Medical Augmentation Response Team – Preventive Medicine (SMART-PM) and the Special Medical Augmentation Response Team – Chemical/Biological (SMART-CB).

The mission of the SMART-PM is to provide short duration Expert Preventive Medicine Augmentation to DoD, other Federal, State and Local Agencies during regional and domestic emergencies, civil-military cooperative actions, weapons of mass destruction, humanitarian and disaster relief operations. The SMART-PM can:

- Conduct public health assessment and community characterization to help identify the population at risk.
- Conduct environmental health consultation to help identify possible hazards and threats that may be a target or result of industrial terrorism.
- Conduct health risk assessment to help determine the possible effects of toxic industrial material exposures and assist in development of educated casualty estimates and controls.
- Conduct hazard countermeasures planning to help protect DoD response assets and assist with planning for safe consequence restoration and recovery.
- Serve as DoD Public Health and Environment Technical Liaisons to other DoD assets and Federal
- Provided emergency support functions.

In general, SMART-PM can provide expert consultation for the re-entry and restoration portions of the consequence management phase of federal emergency response in the following areas:

- Health Physics (Nuclear/Radiological)
- Epidemiology & Disease Surveillance
- Medical Entomology
- Environmental Health Science
- Toxicology
- Industrial Hygiene
- Environmental Sampling and Analysis (Air, Water and Soil)
- Health Risk Assessment
- Sanitation and Hygiene
- Solid & Hazardous Waste Management
- Health Risk Communication

SMART-PM normally would work in support of SBCCOM's C/B-RRT during a WMD response mission.

The National Medical Chemical and Biological Advisory Team (MCBAT) is comprised of USAMRMC elements from the U.S. Army Medical Research Institute of Infectious Diseases (USAMRIID) and the U.S. Army Medical Research Institute of Chemical Defense (USAMRICD). These assets are Tier 1 elements of the DoD Chemical Biological Rapid Response Team (C/B-RRT) and are ready to deploy worldwide within 4 hours after receiving their orders. The RMC Chemical/Biological SMARTs are trained medical teams located at the RMCs that can deploy in response to a chemical, biological, or radiological incident. Examples of incidents that may require a rapid response include:

- An accident involving the transport or storage of NBC weapons,
- The release of CW or BW agents or radiological material,
- A leak of an industrial chemical, infectious material, or radioactive material.

The MCBAT is the principal DoD medical advisor to the Commander, C/B-RRT and the Interagency Response Task Force. Both the MCBAT and regional Chemical/Biological SMARTs can provide medical advice and consultation to commanders or local medical and political authorities for preparation of a response to a threat or actual incident. They can also provide medical advice to commanders or local authorities on protection of first responders and other health care personnel, casualty decontamination procedures, first aid (for non-medical personnel) and initial medical treatment, and casualty handling. The initial advice includes identifying signs and symptoms of NBC exposure, first aid (self-aid, buddy aid, combat lifesaver aid for military personnel), and initial treatment when an incident has occurred. The MCBAT also assists in facilitating the procurement of needed resources. The RMC Chemical/ Biological SMART may, after initial assessment of the situation, elect to use telemedicine reach back.

The US Army Medical Research Institute of Chemical Defense (USAMRICD) has developed a Chemical Casualty Site Team (CSST) with the capability of rapid deployment in support of DoD or the MCBAT as part of the Foreign Emergency Response Team (FEST), or the Domestic Emergency Response Team (DEST). The team is tasked to support each specific mission. Personnel available for deployment consist of physicians, a nurse, toxicologists, veterinarians, and laboratory specialists. These personnel, when coupled with their supporting capabilities, are knowledgeable in the medical effects of a specific chemical warfare agent, identification of chemical agents or their metabolites in biological samples, determination of blood cholinesterase levels, technical and biomedical expertise required to enable protection of personnel responding to chemical incidents or to guide decontamination of personnel and casualties, and technical expertise to accomplish mission planning.

The U.S. Army Medical Research Institute of Infectious Diseases (USAMRIID) has developed the capability to deploy an Aeromedical Isolation Team (AIT) consisting of physicians, nurses, medical assistants, and laboratory technicians who are specially trained to provide care to and transport patients with disease caused by biological warfare agents or by infectious diseases requiring high containment. The AIT is a highly specialized medical evacuation asset for the evacuation of limited numbers of contagious casualties, with lethal infectious diseases, or for consultation on appropriate management of such casualties in the event of a mass casualty situation. USAMRIID's teams are deployable worldwide on a 12-hour notice using USAF transportation assets.

Another asset that USAMRIID has is the Biological Threat Response Cell (BTRC). The BTRC is designed to respond to any CONUS or OCONUS biological warfare or biological terrorist event. The cell is composed of the Deputy Commander as OIC/POC, the Operational Medicine physicians and the AIT, selected scientists and clinicians, a Biological Safety Officer, a logistician and an engineer. USAMRIID also provides consultants to the Chem-Bio Rapid Response Team as members of the MCBAT.

As a supporting capability, USAMRIID has a 16-bed ward with the capability of isolating (up to Biosafety Level 3) patients with infectious diseases in a contingency situation. USAMRIID also has a special Biosafety Level 4 (highest level of containment) patient care area designed for a maximum of 4 patients requiring this level of containment. These patient care

areas are capable of providing intensive care for critically ill patients with specialized personnel and equipment augmentation from Walter Reed Army Medical Center. An additional supporting capability at USAMRIID is its capacity for medical diagnostic assays for recognized biological agents.

5.7.7 Medical Countermeasures and Surveillance against NBC and other Battlefield Toxicants and Occupational Health Hazards

Presidential Review Directive (PRD)/National Science and Technology Council (NSTC)-5 directs DoD, the Department of Veterans Affairs, and the Department of Health and Human Services to review policies and programs and develop a plan that may be implemented by the Federal government to better safeguard those individuals who may risk their lives to defend our Nation's interests. An NSTC Interagency Working Group oversaw the work of four task forces that focused on (1) deployment health, (2) record keeping, (3) research, and (4) health risk communication.

Deployment can encompass a wide range of missions which in addition to operations in NBC environments may expose a Joint Task Force to other toxic chemicals, radiological contamination, and environmental contamination from industrial operations within the host nation. Historically, most veterans' health and benefit issues related to service in combat operations. Now, U.S. forces are more likely to deploy into non-combat environments such as peacekeeping, peacemaking, humanitarian assistance, or training. Pre-deployment medical screening of U.S. Forces prior to deployment is now a DoD requirement.

Joint Medical Surveillance within the Joint Operational Area should be initiated at the earliest opportunity to provide the Joint Force Commander with the information needed to position U.S. forces safely upon deployment. Medical surveillance information also is useful in identifying and applying pre-deployment medical countermeasures to protect the health of the force. More detailed information on PRD5 is available at "<http://www.whitehouse.gov/WH/EOP/OSTP/NSTC/html/directive5.html>."

It is DoD policy that pre- and post-deployment health assessments and blood sample collections shall be required for all troop movements of active and reserve component personnel resulting from a Joint Chiefs of Staff/Unified Command deployment order for 30 continuous days or greater to a land-based location outside of the United States that does not have a permanent U.S. military treatment facility. Routine shipboard operations that do not involve field operations ashore for over 30 days are exempt from this policy. The details for completing these assessments are found in JCS Policy Memorandum MCM-251-98, 4 December 1998, subject: Deployment Health Surveillance and Readiness; ASD(HA) Policy Memorandum, 6 October 1999, subject: Policy for Pre- and Post-Deployment Health Assessment and Blood Samples; and DoD Instruction 6490.3, "Implementation and Application of Joint Medical Surveillance for Deployments," August 7, 1997. All policy memorandums, instructions, and copies of blank DD forms can be found on the internet at <http://www.cba.ha.osd.mil> — select "Projects/Deployment

Recent deployments have confronted the JFC with toxic industrial chemicals, radiological hazards, and long term environmental contamination from industrial operations within the host nation. Standard U.S. occupational health and environmental standards are not effective for protecting the force during these deployments. The Joint Force Commander must utilize organic NBC reconnaissance and preventive medicine medical surveillance assets to identify host nation occupational and environmental hazards and to determine troop deployment locations that will minimize the short- and long-term health risk during occupation by U.S. forces. Prior identification of potentially hazardous industrial or medical sites and areas of known environmental contamination are essential to the risk management and risk communication process. This type of information if not provided by the host nation is available from the Armed Forces Medical Intelligence Center and the U.S. Army Center for Health Promotion and Preventive Medicine (USACHPPM). Factors to be considered will include the type of contamination and the prevailing wind direction. Planning factors for downwind hazard distances for some commonly known industrial chemicals are provided USACHPPM Technical Guide 230A, "Short-Term Chemical Exposure Guidelines for Deployed Military Personnel". The "target population" consists of healthy deployed military personnel. The technical guide is to be used as a tool to assess potential adverse health impacts resulting from exposure to harmful chemicals as a result of uncontrolled industrial release, sabotage, or from the intentional or unintentional actions of enemy or friendly forces.

The Joint Publication 3-11, *Doctrine for Nuclear, Biological, and Chemical Defense Operations* is currently focused only on the use of NBC weapons in a global war. It is being updated to take into account new DoD and JCS policies, directives, and instructions for joint medical surveillance and risk communication. Current military deployments are Stability and Support Operations (SASO), peacekeeping, or humanitarian in nature. Commanders are being confronted with industrial hazards and environmental contamination within the host country which place the health of the force at risk. New DoD standards and guidelines are being developed for accurate risk communication. The Assistant Secretary of the Army for Installations, Logistics, and Environment, ASA(ILE), is the DoD Executive Agent for developing these new DoD nuclear, biological, chemical, and environmental (NBC-E) force protection policies.

Central to force protection is the integration into campaign and operational plans of medical force protection measures such as risk management and risk communication. Medical counter-measures include pre- and post- deployment medical screening, immunizations, medical pre-treatments, NBC casualty treatments, and medical record keeping. Functions being considered in medical readiness planning are area medical support, hospitalization, evacuation, preventive medicine, and laboratory. Joint medical surveillance within the theater of operations can identify NBC related occupation, industrial, and environmental health hazards. Preventive medicine assets within the theater can be employed to conduct joint medical surveillance and to provide recommendations to the Joint Force Commander for risk communication to minimize the short-term and long-term health effects of toxic exposures to deployed military personnel. DoD Directives (6055.1 and 6490.2) and Instruction (6490.3) as they apply to joint medical surveillance and safety and occupational health in an NBC or otherwise contaminated environment can be found at <http://web7.whs.osd.mil.corres.htm>.

5.7.8 Air Force Modular NBC Teams

The Air Force Medical Readiness Re-engineering efforts have created eight specialty teams for NBC Medical Defense. These teams include (1) Theater Epidemiology Team, (2) Radiological Assessment Team, (3) Wartime Patient Decon Team, (4) Bioenvironmental Engineering NBC Team, (5) Infectious Diseases Team, (6) Preventative Aerospace Medicine Team, (7) Biological Augmentation Team, and (8) In-place Patient Decon Team (USAFE). Following is a brief description of the capabilities provided by these teams.

The Theater Epidemiology Team provides (1) theater medical and environmental threat assessments, (2) theater disease surveillance and disease outbreak investigation, and (3) baseline environmental monitoring.

The *Radiological Assessment Team* is composed of two Nuclear Incident Response Force (NIRF) Teams and one Radioanalytical Augmentation Team. The NIRF Teams include health physicists, industrial hygienists, equipment technicians, and bioenvironmental technicians.

The *Wartime Patient Decon Team* is deployed in direct support medical treatment facilities operating in NBC threat environments. They construct decontamination sites and facilities in the vicinity of the medical treatment facilities.

The *Bioenvironmental Engineering NBC Team* provides the following capabilities: (1) NBC agent surveillance, detection and abatement, (2) reconnaissance teams for NBC agent detection, (3) advice on health effects and human performance due to extended wear of the ground crew ensemble, (4) information on other NBC related health risks to deployed forces.

The *Infectious Diseases Team* provides personnel that augment the capability to identify, control, report, and provide treatment for infectious diseases and biological warfare agents in the deployed theater. The Team is designed to be deployed to facilities with greater than 100 beds where a significant threat for biological warfare casualties or infectious disease exists.

The *Preventative Aerospace Medicine Team*: (1) identifies, monitors and prevents disease and non-battle injury (DNBI), (2) performs health threat and risk assessment, (3) performs health hazard surveillance, (4) controls health hazards, and (5) mitigates the effects and prevents DNBI.

The *Biological Augmentation Team* is a two-person team that provides rapid pathogen identification using DNA-based detection capability. The team is modular so that it may augment other teams, capabilities, and facilities.

The *In-place Patient Decon Team* supports five U.S. Air Forces in Europe (USAFE) medical treatment facilities (MTF).

5.8 READINESS REPORTING SYSTEM

CJCSI 3401.02, the policy document for the Status of Resources and Training System (SORTS) requires units from all Services to independently assess their equipment on hand and training status for operations in a chemical and biological environment. This is a change to previous SORTS reporting requirements and provides more visibility to NBC defense related issues.

The Services individually monitor their SORTS data to determine the type of equipment and training needing attention. Units routinely report their equipment on hand and training status for operations in a chemical or biological environment. Commanders combine this information with other factors, including wartime mission, to provide an overall assessment of a unit's readiness to go to war.

Additionally, the Commanders-in-Chief (CINCs) of the Unified Commands submit readiness assessments at each Joint Monthly Readiness Review (JMRR). In the JMRR, CINCs assess the readiness and capabilities of their command to integrate and synchronize forces in executing assigned missions. As needed, CINCs address NBC defense readiness and deficiencies as part of the JMRR.

5.9 NBC DEFENSE TRAINING AND READINESS ASSESSMENT

ISSUE: There are limited chemical and biological features in wargaming and planning models.

SOLUTION: Funding to add chemical and biological warfare defense to joint simulations has been allocated by the JSIG M&S Commodity Area for FY99 and beyond. The program will focus on incorporating chemical effects into JCATS and JSIMS in FY99-00 and BW effects in FY00-01. To add CB defense capabilities to OneSAF, the possibility of incorporating the CB-ModSAF model developed by SBCCOM will be considered.

(INTENTIONALLY BLANK.)

Chapter 6

Status of DoD Efforts to Implement the Chemical Weapons Convention (CWC)

6.1 INTRODUCTION

The Chemical Weapons Convention (CWC) was opened for signature on January 13, 1993. The Convention entered into force on April 29, 1997. As of 23 December 1999, 129 countries, including the United States, had signed and ratified the CWC. Another 41 countries have signed but not ratified.

6.2 DEPARTMENT OF DEFENSE IMPLEMENTATION OF THE CWC

Since the CWC entered into force, DoD has hosted 117 visits and inspections at chemical weapons storage, former production, and destruction facilities. The Army, (the Service most directly impacted by CWC implementation activities), and the Defense Threat Reduction Agency's On-Site Directorate, DTRA(OS), continue to host and escort Organization for the Prohibition of Chemical Weapons (OPCW) Technical Secretariat inspectors, who conduct both continuous monitoring at DoD CW destruction facilities and systematic inspections at DoD CW storage and former production facilities.

The Department of Defense conducts a Chemical Weapons Agreements Implementation Working Group (CWIWG) to implement the CWC. Through regularly recurring meetings, representatives of the Office of the Secretary of Defense (OSD), the Joint Staff, the Military Departments, the Military Services, and DoD agencies and activities coordinate planning efforts to ensure proper implementation of the CWC. Formal meetings of the CWIWG are scheduled approximately monthly and small group meetings are held as needed to address specific requirements in support of the CWIWG. A Compliance Review Group (CRG) was established within DoD to meet as needed to address CWC compliance concerns, should they arise.

OSD, the Joint Staff, the Military Services, and DTRA provide technical experts to support activity at the U.S. Delegation to the OPCW in The Hague, The Netherlands. The OPCW is charged with overseeing worldwide implementation of the CWC.

The Army was tasked to destroy all chemical warfare materiel under the Program Manager for Chemical Demilitarization (PMCD). PMCD includes programs for unitary stockpile destruction, destruction of bulk agent by alternative technologies (non-incineration), and destruction of other chemical warfare materiel and former CW production facilities. There is a separate non-PMCD program to demonstrate alternative technologies to destroy assembled CW munitions. DoD and the Army coordinate closely to ensure that these programs are compliant with CWC provisions.

6.3 SAFETY ORIENTATION FOR INSPECTORS

OPCW inspectors who conduct continuous monitoring at U.S. chemical weapons demilitarization facilities have attended a 32-hour safety orientation which is broken down into two sections. One section is a 24-hour hazardous waste operations and emergency response (HAZWOPR) course which is a U.S. Government requirement of all personnel who must be present on a more than short-term basis at U.S. chemical demilitarization facilities. The second section is an 8-hour demilitarization protective ensemble (DPE) procedures course required only for those inspectors designated by the OPCW Technical Secretariat, whose responsibilities would include the use of such protective equipment. Approximately 450 inspectors have attended HAZWOPR training; some 110 of the 450 inspectors have taken the 48-hour DPE class. The orientation is conducted at the Chemical Demilitarization Training Facility in Edgewood, MD. Annual 8-hour HAZWOPR refresher classes are also required, and are being accomplished.

6.4 PREPARATION OF DEFENSE INSTALLATIONS

The Military Services and DTRA have developed individual implementation and compliance plans to provide guidance for their commands and activities under the CWC.

The Military Services have individually established implementation support offices which participate actively at the DoD CWIWG, provide Service policy direction, and conduct ongoing liaison with their major commands to ensure that all military elements are fully prepared for inspections under the CWC.

The Military Services and DTRA continue to prepare DoD installations for inspections under the CWC. All defense installations which are subject to declarations under the requirements of the CWC, and many which are subject to challenge inspections even though not declared, have been visited by Military Service representatives and DTRA technical experts. DTRA will continue to support site assistance visits and Army treaty compliance implementation meetings.

All of the Military Services have held exercises to test their preparedness for short-notice CWC challenge inspections. Such exercises involve the active participation of Service, DTRA, and other DoD representatives in the roles they would assume during a real challenge inspection. DoD and the Services have exercised written DoD guidance and procedures to test the operational readiness of personnel and facilities. Commonly, the lead Service responsible for developing an exercise also produces comprehensive lessons-learned to further ensure DoD readiness for challenge inspections. The Services have initiated efforts to ensure that in the case of a challenge inspection affected commands take timely and appropriate measures, based on lessons-learned, to demonstrate compliance while protecting security concerns.

6.5 DEFENSE TREATY INSPECTION READINESS PROGRAM

The Defense Treaty Inspection Readiness Program (DTIRP), for which DTRA is the executive agent, has implemented an extensive outreach program to provide information about the CWC, security countermeasures, facility preparation, to both government and DoD industry. DTIRP provides training and awareness services through such fora as industry seminars, mock inspections, mobile training teams, industry associations, national conventions and symposia. DTIRP speakers participated in more than 55 outreach events during the last fiscal year. DTIRP also publishes various educational products (printed and video) and administers electronic bulletin boards to provide information concerning the CWC to government and industry. DTIRP, in close coordination with the Naval Surface Warfare Center at Indian Head, MD, has also produced and conducted the first Chemical Technology Security Course, to be given annually.

6.6 ARTICLE X ASSISTANCE AND OTHER ASSISTANCE

Under Article X of the CWC, a State Party to the treaty may make an appeal for assistance to the Director-General of the OPCW. In accordance with a condition established in the U.S. Senate's advise and consent to the ratification of the CWC, the United States will provide no assistance other than medical antidotes and treatment, which the U.S. Government deems are necessary, to those CWC States Parties that have requested assistance under Article X of the CWC.

Under the CWC, DoD has not provided any chemical weapons detection equipment, or assistance in the safe transportation, storage, and destruction of chemical weapons to other signatory nations. Such assistance, however, is being provided to Russia under DoD's Cooperative Threat Reduction (CTR) program, a program not directly related to the CWC.

6.7 ARMS CONTROL TECHNOLOGY

DTRA conducts RDT&E to support U.S. roles in global chemical weapons (CW) control initiatives. The primary goal of the program is to protect DoD equities and minimize the threat to national security interests posed by U.S. involvement in CW arms control activities. A related objective is to assist the United States in meeting legal obligations imposed by treaty provisions, support development of U.S. policy, minimize implementation costs, and enhance the safety of inspections. Projects that support implementation and compliance requirements are approved by the CW Treaty Manager. Current emphasis is on technologies and procedures for on-site analysis under the CWC. Other key development areas include non-destructive evaluation and off-site monitoring.

(INTENTIONALLY BLANK.)

Annex A

Contamination Avoidance Programs

SECTION 1: FIELDED AND PRODUCTION ITEMS

DETECTORS AND MONITORS

Chemical Agent Monitor (CAM) and Improved Chemical Agent Monitor (ICAM)

The CAM is a hand held instrument capable of detecting, identifying, and providing relative vapor hazard read-outs for G and V type nerve agents and H type blister agents. The CAM uses ion mobility spectrometry (IMS) to detect and identify agents within one minute of agent exposure. A weak radioactive source ionizes air drawn into the system, and the CAM then measures the speed of the ions' movement. Agent identification is based on characteristic ion mobility and relative concentrations based on the number of ions detected.

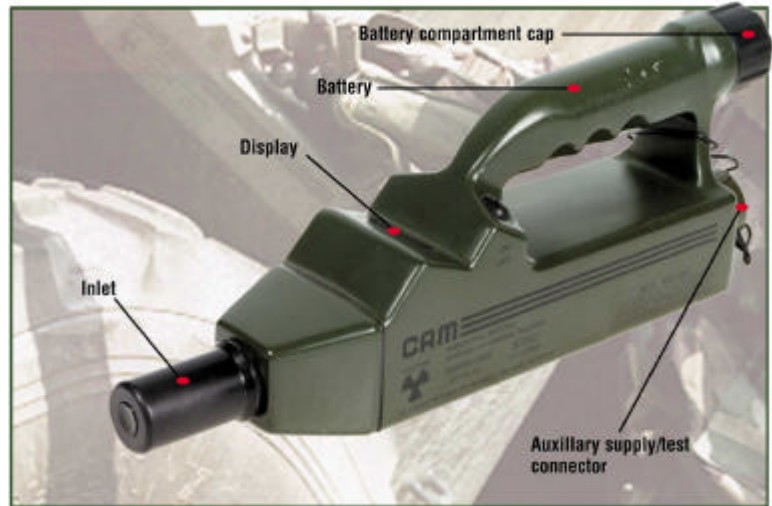

The ICAM has the same chemical agent detection capability as the CAM; improvements are that it is 300% more reliable, starts up 10 times faster, and the modular design is much less expensive to repair. The ICAM has the additional features of an RS-232 data communications interface, and the ability to be programmed for new/different threat agents. The four pound, 15" long ICAM can be powered either by an internal battery or by an external source through the ICAM's combination power/fault diagnosis/RS-232 plug. The ICAM may be used for a variety of missions, to include area reconnaissance and area surveillance, monitoring of decontamination operations, and medical triage operations. The ICAM significantly reduces the level and frequency of maintenance vs. CAM without affecting performance. The ICAM sieve pack has double the capacity of the two CAM sieve packs, which results in twice the operational life of the ICAM over the CAM. When fielded, the ICAM will significantly reduce operating and sustainment costs associated with the CAM by \$135 million over its life cycle in present day dollars. This savings is based on the total planned procurement of the ICAM, and would be greater if all CAMs were replaced by ICAMs.

M31 Biological Integrated Detection System (BIDS) Non-Developmental Item (NDI) & Pre-Planned Product Improvement (P3I)



BIDS uses a multiple technology approach, both developmental and off-the-shelf materiel, to detect biological agents with maximum accuracy. BIDS is a vehicle-mounted, fully integrated biological detection system. The system, which is a collectively-protected, HMMWV-mounted S788 shelter, is modular to allow component replacement and exploitation of “leap ahead” technologies. The system is capable of detecting and presumptively identifying four BW agents

simultaneously in less than 45 minutes. Thirty-eight BIDS (NDI versions, shown) were fielded to the 310th Chemical Company (U.S. Reserve) during FY96. This gave DoD its first credible, rapidly deployable biological detection capability. The BIDS is a Corps level asset. The P3I BIDS is capable of detecting and presumptively identifying 8 BW agents simultaneously in 30 minutes. The suite is semi-automated and contains next generation technologies such as the Ultraviolet Particle Sizer, Chemical Biological Mass Spectrometer, and the Biological Detector. 38 systems were recently fielded to the 7th Chemical Company.

The Biological Detector is an antibody-based device capable of identifying specific biological agents. It consists of electronics processing equipment, fluid processing modules, reservoirs for antibody reagents, and a light addressable potentiometric sensor to provide biological agent identification. The total processing time, from insertion of sample to data readout, will be approximately 15 minutes at threshold concentrations. The biodetector includes an operator display which will provide identification and relative concentration of the biological agent detected. Built-in tests will also be provided to identify system malfunctions.

CBMS detects and characterizes all known chemical and biological threat agents. It continuously and automatically detects threat agents via a mass analyzer chassis, a biological aerosol sampling probe, a surface sampling probe and sample identification device. The mass analyzer chassis houses the mass analyzer, pumps, control electronics, and computers. With the aerosol probe attached, the CBMS detects biological agent aerosols and chemical agents as aerosols and/or vapors in the air. With the ground probe attached, the CBMS detects chemical agents whether they exist as airborne vapors or aerosols, or as liquid droplets on surfaces. The CBMS will replace the MM1 and be mounted within the NBC Recon System to search for areas of CB agent contamination.



Interim Biological Agent Detector (IBAD)

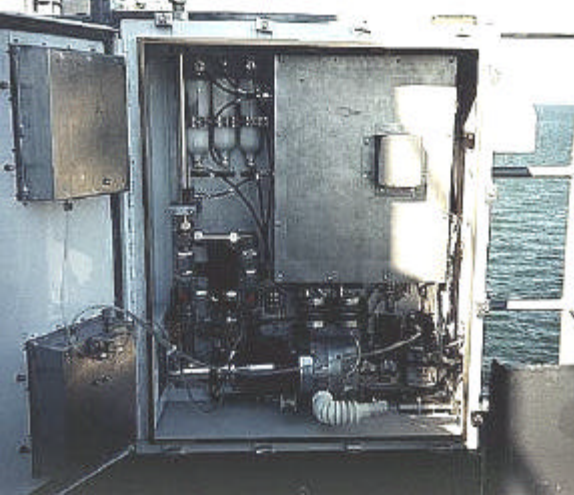

IBAD provides shipboard detection of biological warfare agents. IBAD consists of a particle sizer/counter, wet wall cyclone particle sampler, and hand held colorimetric, immunochemical assay tickets for identification of suspect aerosol particles (through hand-held assay). IBAD is capable of detecting an increase in the particulate background, which may indicate a man-made biological attack is underway, and sampling the air for identification analysis. IBAD can detect a change in background within 15 minutes, and can identify biological agents within an additional 30 minutes. It is a rapid prototype system that started service with the fleet in FY96. Twenty IBAD systems are currently

fielded. These systems will be among ship platforms as dictated by fleet priorities.

Portal Shield ACTD Residuals

Portal Shield is an interim capability for biological detection at high value fixed overseas sites. The system uses an innovative network of sensors to increase probability of detecting a BW attack while decreasing false alarms and consumables. The Portal Shield system consists of a variable number of biological sensors forming a network under the command and control of a centralized command post (CP) computer. The CP communicates with and monitors the operation of each sensor. The Portal Shield system can detect and identify up to eight BW agents simultaneously in less than 25 minutes. The Portal Shield was successfully deployed overseas in support of Operation Desert Thunder, and was also successfully operated during the NATO 50th anniversary. Four overseas sites are currently fielded and outfitted with Portal Shield networks.

M256A1 Chemical Agent Detector Kit

The M256A1 kit can detect and identify field concentrations of nerve agents (sarin, tabun, soman, GF, and VX), blister agents (mustard, phosgene oxime, mustard-lewisite, and lewisite), and blood agents (hydrogen cyanide and cyanogen chloride) in both vapor and liquid form in about 15–20 minutes. The kit consists of a carrying case containing twelve chemistry sets individually sealed in a plastic laminated foil envelope, a book of

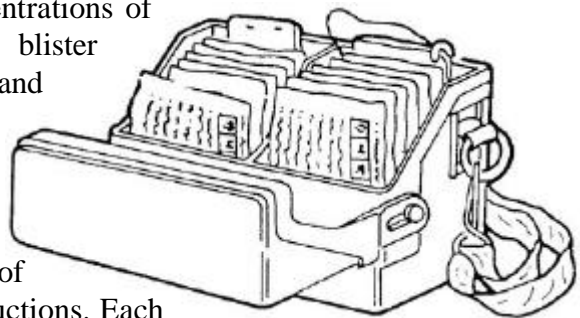

M8 chemical agent detector paper, and a set of instructions. Each detector ticket has pretreated test spots and glass ampoules containing chemical reagents. In use, the glass ampoules are crushed to release a reagent, which runs down pre-formed channels to the appropriate test spots. The presence or absence of chemical agents is indicated through specific color changes on the test spots. The kit may be used to determine when it is safe to unmask, to locate and identify chemical hazards (reconnaissance), and to monitor decontamination effectiveness.

ABC-M8 VGH, and M9 Chemical Agent Detector Paper

M8 and M9 paper are dye impregnated papers that change color when exposed to liquid chemical agents or aerosols. These papers cannot detect chemical agents in vapor form. M8 paper comes in 4" by 2 1/2" booklets. Each booklet contains 25 sheets of detector paper that are capable of detecting G series nerve



agents (sarin, tabun, soman, and GF), V type nerve agents, and H (mustard) type blister agents. M8 paper can identify agents through distinctive color changes from its original off-white: yellow-orange for G, blue-green for V, and red for H. M8 paper is typically used to identify unknown liquid droplets during chemical reconnaissance/ surveillance missions. M9 (SR119) detector paper is rolled into 2-inch wide by 30-foot long rolls on a 1.25-inch diameter core. Although M9 paper cannot distinguish the identity of G and V nerve agents, H blister agents, and L agents, it does turn pink, red-brown, red-purple, or another shade of red when exposed to liquid or aerosol chemical nerve and blister agents. M9 paper is typically placed on the BDO, equipment, and vehicle exteriors to warn personnel of the presence of a liquid chemical agent.

M18A2 Chemical Agent Detector Kit

The M18A2 can detect and identify dangerous concentrations of nerve agents (sarin, tabun, soman, GF, and VX), blister agents (mustards, phosgene oxime, mustard-lewisite mixture, phenyl dichlorarsine (PD), ethyl dichlorarsine (ED), and methyl dichlorarsine (MD)), blood agents (hydrogen cyanide and cyanogen chloride), and choking agents (phosgene) in about 1–4 minutes. The kit is also used to confirm results of the M256A1 kit. The M18A2 kit contains a squeeze bulb and enough detector tubes, detector tickets, and chemical reagents needed to conduct 25 tests for each agent vapor. The kit also contains a booklet of M8 chemical agent detector paper to detect liquid agents. Agent vapor detection is indicated by the production of a specific color change in the detector tubes. The M18A2 kit was fielded in 1982 and only used by special teams such as surety teams or technical escort personnel.

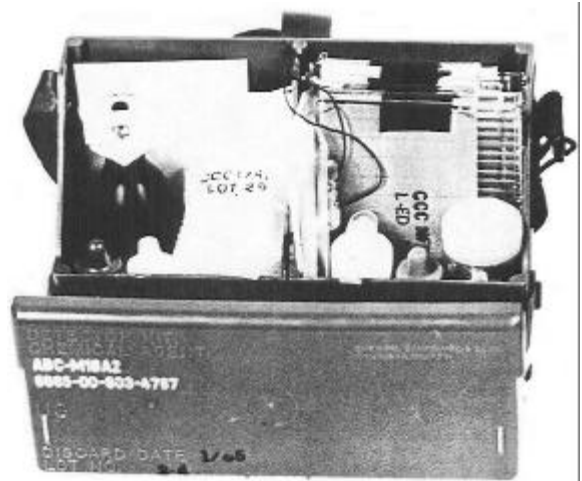

M272 Water Test Kit

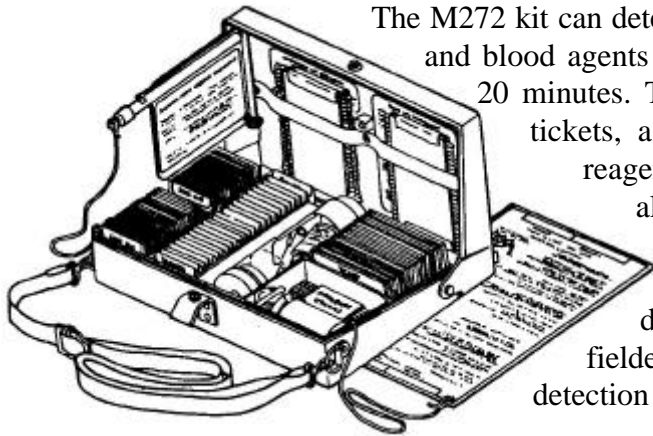

The M272 kit can detect and identify hazardous levels of nerve, blister, and blood agents in treated or untreated water resources in about 20 minutes. The kit contains enough detector tubes, detector tickets, a test bottle, and pre-packed, pre-measured test reagents to conduct 25 tests for each agent. The kit also contains simulants used for training. Agent detection in water is indicated by the production of a specific color change in the detector tubes or in the ticket. The M272 was fielded in 1984 and does not meet current lower level detection requirements.

M8A1 Automatic Chemical Agent Alarm (ACAA)

The M8A1 ACAA is a system that continuously samples the air to detect the presence of dangerous concentrations of G and V type nerve agent vapors. This system is being phased out of the inventory and will be replaced by the M22 ACADA. The M8A1 ACAA may be employed in a number of configurations, but all configurations are built around the M43A1 detector unit and the M42 alarm unit. The configurations differ primarily in their mountings and power supplies: ground mounted and battery operated, or mounted on a vehicle and powered by the vehicle's electrical system. The M43A1 detector unit measures 6 1/2" x 5 1/2" x 11" with the battery used in ground mounted operations adding another 7 3/4" in height. The M43A1 detector unit uses a radio-isotope to ionize molecules in the air that is pumped through

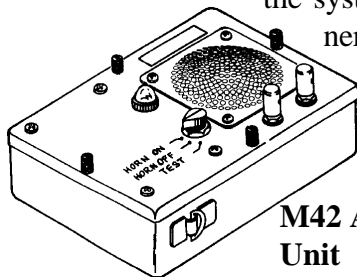
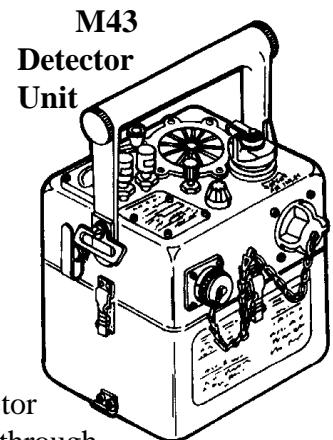

M42 Alarm Unit

the system, then detects electrical current changes that occur in the presence of nerve agents. The M43A1 detector unit will alarm within about 1-2 minutes from exposure to agent. The M42 alarm unit is a remote visual and audible alarm that measures 7" x 4" x 2 1/3". The M42 alarm unit may be placed up to 400 meters from the M43A1 detector unit to give users warning of an approaching agent cloud.

M-90 Automatic Agent Detector (AMAD)

The AMAD is an automatic nerve and mustard agent detector that detects agents in vapor form. This system is currently in use by the Air Force. It transmits an alarm by radio to a central alarm unit.

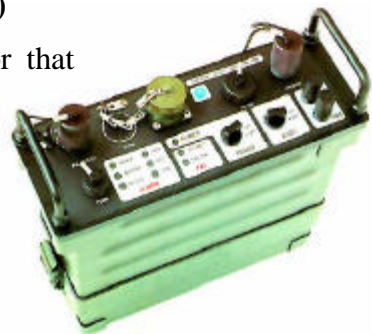

Automatic Liquid Agent Detector (ALAD)

The ALAD is a liquid agent detector that can detect droplets of GD, VX, HD, and L as well as thickened agents. It transmits its alarm by field wire to a central alarm unit. Although the remote transmission is useful, the device only detects droplets of liquid agents. It must be used in conjunction with other point or standoff vapor agent detectors to afford a complete detection capability.



Chemical Agent Point Detection System (CAPDS), MK21, MOD1

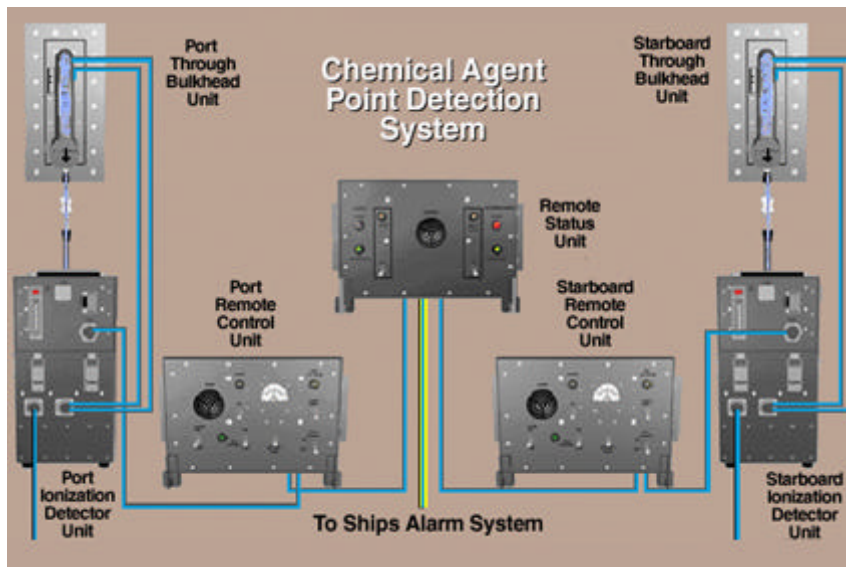

CAPDS is a fixed system capable of detecting nerve agents in vapor form, using a simple baffle tube ionization spectrometer. Installed in a ship's upper superstructure level, CAPDS obtains a sample of external air, ionizes airborne vapor molecules, and collects them on a charged plate after eliminating lighter molecules via the baffle structure. When a sufficient mass of ions is collected, a pre-set potential is achieved, and an alarm signal is generated and sent to both

Damage Control Central and the bridge. The system has been installed on almost all surface ships.

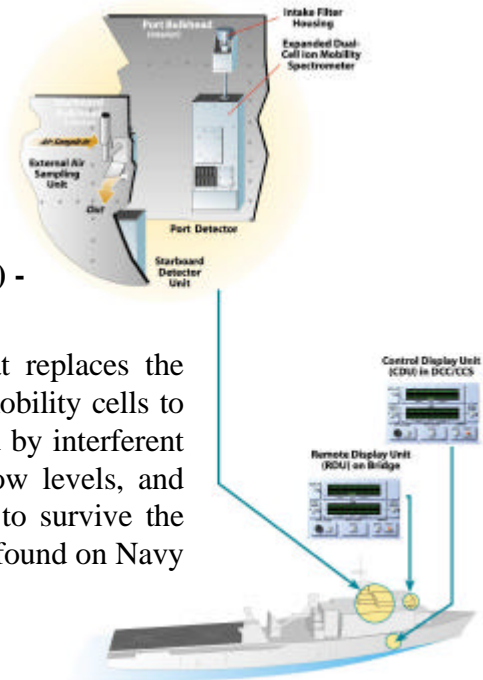

Improved (Chemical Agent) Point Detection System (IPDS) - Production

The IPDS is a new shipboard point detector and alarm that replaces the existing shipboard CAPDS. IPDS uses special elongated ion mobility cells to achieve the resolution necessary to counter false alarms caused by interferent vapors. IPDS can detect nerve and blister agent vapors at low levels, and automatically provide an alarm to the ship. The unit is built to survive the harsh sea environment and the extreme electromagnetic effects found on Navy ships.

M22 Automatic Chemical Agent Detection Alarm (ACADA)

ACADA is a man-portable, point sampling alarm system that provides significant improvement over current capabilities; it detects and identifies all nerve agents, mustard, and lewisite, by class. ACADA provides concurrent nerve and blister agent detection, improved sensitivity and response time, agent identification capability, improved interference rejection, extensive built-in test, a data communications interface, and the capability to be programmed for new threat agents. It replaces the M8A1 Alarm as an automatic point detector and augments the CAM as a survey instrument. The ACADA consists of an off-the-shelf non-developmental item (NDI)—the GID-3 chemical agent alarm. A shipboard version of the ACADA is being built to address the unique interferents found aboard Navy ships that cause false alarms on the NDI ACADA. The shipboard version of ACADA will serve to cover the Navy's emergency requirements until the Joint Chemical Agent Detector can be fielded.

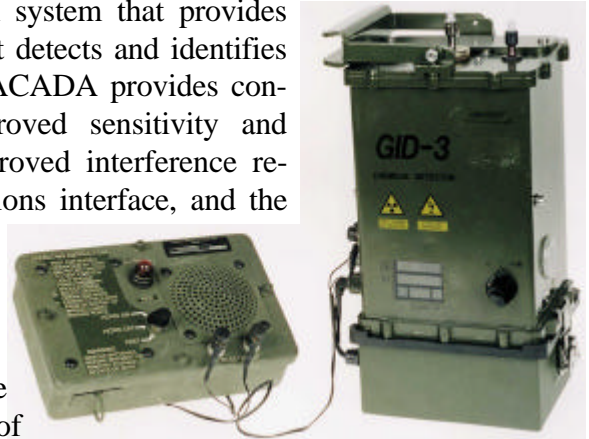

STAND-OFF DETECTION AND REMOTE/EARLY WARNING

AN/KAS-1/1A Chemical Warfare Directional Detector (CWDD)

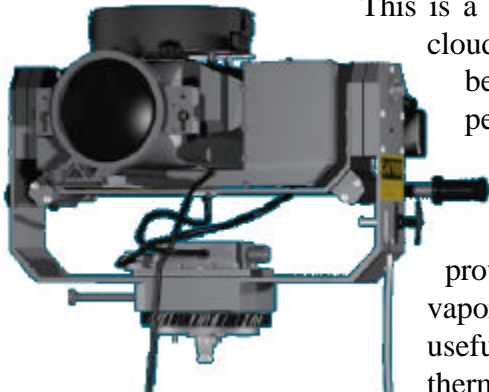

This is a semi-portable system designed to detect nerve agent vapor clouds at ranges up to five kilometers. The AN/KAS-1/1A must be removed from its stowage case and set up on a pre-installed pedestal for operation. A trained, diligent operator must manually aim the detector at the suspect cloud and interpret its infrared images to determine whether or not the cloud contains nerve agent vapors. The AN/KAS-1A provides a remote video display, an enhanced capability for vapor cloud analysis, and a remote relative bearing indicator useful for avoiding the agent cloud or other surface target with a thermal signature.

M21 Remote Sensing Chemical Agent Alarm (RSCAAL)

The M21 RSCAAL is an automatic scanning, passive infrared sensor that detects nerve (GA, GB, and GD) and blister (H and L) agent vapor clouds based on changes on the infrared spectrum caused by the agent cloud. It is effective at line-of-sight distances of up to five kilometers. The alarm is used for surveillance and reconnaissance missions in both vehicle-mounted and tripod-mounted modes.



Long Range Biological Stand-off Detector System (LRBSDS) - NDI



LRBSDS utilizes elastic backscatter and infrared light detection and ranging (IR-LIDAR) technology to detect, range, and track particulate clouds that are indicative of a BW attack; the LR-BSDS cannot discriminate biological from non-biological clouds. The system, which is approximately 1,240 pounds and 2.3 cubic meters, has three major components: a pulsed laser transmitter operating at IR wavelengths; a receiver and telescope; and an information processor and display. The system is mounted on a UH 60 Blackhawk helicopter for operations. This program has

been designed in two phases; an NDI phase designed to rapidly field an interim capability and a pre-planned product improvement (P3I) phase. The three NDI LR-BSDSs have been fielded to the 310th Chemical Company (USAR). The NDI system is able to detect and track man-made aerosols out to 30 km, but is non-eyesafe out to about 2.5 km. The P3I will provide an eye safe laser system at all ranges, an automated cloud detection and tracking capability, and an increased detection range (50 km). Fielding of the system is currently scheduled for FY01.

NBC RECONNAISSANCE

M93 NBC Reconnaissance System (NBCRS)

The M93 NBC Reconnaissance System, known as the FOX, is a high mobility armored vehicle capable of performing NBC reconnaissance on primary, secondary, and cross country routes throughout the battlefield. The NBCRS was procured as a Non-Developmental Item and is capable of detection, warning and sampling the effects of NBC weapons and is used as a reconnaissance vehicle to locate, identify and mark chemical and nuclear contamination on the battlefield. The M93 FOX usually accompanies the scouts or motorized reconnaissance forces when performing its NBC mission. The NBCRS



has an overpressure filtration system that permits the crew to operate the system in a shirt sleeve environment which is fully protected from the effects of NBC agents and contamination. It utilizes a secure communications system to warn follow-on forces. Samples gathered are forwarded to the Theater Area Medical Laboratory for further analysis and verification. The mobility platform is a six wheeled all wheel drive, armored combat vehicle capable of cross-country operation at speeds up to 65 MPH. The Fox System is fully amphibious and is capable of swimming speeds up to 6 MPH. The M93 NBCRS has been fielded worldwide to the Army and Marine Corps forces.

M93A1 – FOX System

The Block I Modification—M93A1 NBCRS contains an enhanced and fully integrated NBC sensor suite consisting of the M21 RSCAAL, MM1 Mobile Mass Spectrometer, CAM/ICAM, AN/VDR-2, and M22 ACADA. The NBC sensor suite has been digitally linked together with the communications and navigation subsystems by a dual-purpose central processor system known as MICAD. The MICAD processor fully automates NBC Warning and Reporting functions and provides the crew commander full situational awareness of the Fox's NBC sensors, navigation, and communications systems. The M93A1 FOX is also equipped with an advanced position navigation system (GPS & ANAV) that enables the system to accurately locate and report agent contamination. The NDI mobility platform is a six wheeled, all wheel drive armored vehicle capable of cross-country operation at speeds up to 65 MPH. The Fox System is also fully amphibious and is capable of swimming at speeds up to 6 MPH. It is used as a reconnaissance vehicle to locate, identify, and mark chemical and biological agents on the battlefield. The FOX usually accompanies the scouts or motorized reconnaissance forces when performing its NBC mission.



RADIACS

AN/VDR-2



The AN/VDR-2 measures gamma dose rates from 0.01 $\mu\text{Gy/hr}$ (micro-Grays per hour) to 100 Gy/hr and beta dose rates from 0.01 $\mu\text{Gy/hr}$ to 5 cGy/hr. The unit functions simultaneously as a dose rate meter and dose meter with independent adjustable alarms that can be set at any level over the entire range. Dosage data is independently stored in non-destructive memory for display on command and

may be retained when the unit is turned off. The unit is powered by three 9 volt batteries.

AN/PDR-75 Radiac Set

The AN/PDR-75 measures dose from 0 to 999 cGy (centi-Gray). The Radiac Set consists of a dosimeter and a reader. It provides the capability to monitor and record the exposure of individual personnel to gamma and neutron radiation. Each individual will be issued a DT-236/PDR-75 dosimeter. This device, worn on the wrist, contains a neutron diode and a phosphate glass gamma detector. When a determination of exposure is required, the dosimeter is inserted into a



CP-696/PDR-75 reader, which then displays the cumulative neutron and gamma dose. The reader is issued at the company level and the dosimeters are issued to all combat, combat support, and combat service support personnel. The reader can be powered by a BA-5590 lithium battery, vehicle battery, or external power supply via adapter cables provided.

AN/PDR-77 Radiac Set



The AN/PDR-77 Radiac Set is a set of portable radiation detection equipment for detecting alpha, beta, gamma, and x-ray radiation. The set consists of a radiacmeter to which one of three radiation probes can be attached for measuring particular types of radiation. The probes are part of the set. The set includes accessories and basic test and repair parts for unit maintenance including a carrying pouch with shoulder straps capable of holding the radiacmeter, alpha probe, and beta/gamma probe for field use. The entire set is contained in a carrying case (large briefcase) for easy portability and storage.

AN/UDR-13 Pocket RADIAC - Production (FUE FY99)

The AN/UDR-13 Pocket RADIAC is a compact, hand-held, tactical device capable of measuring the gamma dose-rate and gamma and neutron cumulative dose in a battlefield environment. Its pocket size permits convenient use by troops on foot. Alarm pre-sets are provided for both the dose-rate and total dose modes. A push-button pad enables mode selection and functional control. Data readout is by liquid crystal display. It will replace the obsolete IM-93 quartz fiber dosimeter and the PP-1578 Dosimeter Charger.

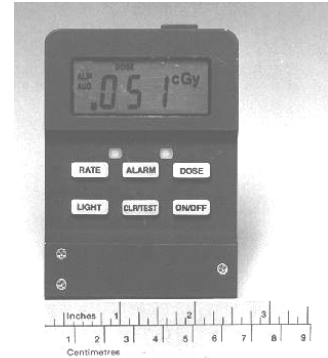

Multi-Function Radiation (MFR) Detector -Production

This program improves radiation detection equipment by replacing the current suite of logistically unsupportable assets. Present detectors (PAC-1S, AN/PDR-43 and AN/PDR-56F) have exceeded maintainability standards. Original manufacturers have either discontinued production or are no longer in business. An improved capability is required to support both wartime and peacetime nuclear accident response operations. A production contract was awarded in March 1995. First deliveries were made in 1997.

ADM-300A Multifunction Survey Meter



The ADM300A is a battery-operated, self-diagnostic, multiple functional instrument. It is used alone to locate and measure low and high intensity radioactivity in the form of gamma rays or beta particles. It is used with external probes to locate and measure alpha, beta, gamma, and x-rays, and neutron radiation.

SECTION 2. RDTE ITEMS**AUTOMATIC DETECTORS AND MONITORS****Agent Water Monitors**

The Joint Service Chemical Biological Agent Water Monitor is a cooperative RDTE effort, chartered to develop a detection system which will detect chemical and biological agents in water. The detector will feature multi-agent capabilities, and operate automatically, improving both ease and response time of existing system. The project will accommodate the four services' requirements for the following:

*In-line CB Detector (IL CBDWS)
Chemical Agent Water Monitor (CAWM)
CB Agent Water Monitor (CBAWM)*

Rationale:

- Joint Army, Air Force, and Marine Corps requirement
- Navy interest

Key Requirements:

- Detect and identify chemical agents and agents of biological origin in water
- Perform monitoring automatically with continuous and batch sampling capabilities
- Easy to operate and support in forward areas, austere environments, and limited lighting

Description:

The Agent Water system will improve current water monitoring and purifying capabilities. It will automatically detect CB agents at or below harmful levels in water and not false alarm to common interferences. The system will be compact, man-portable and easy to use, and be decontaminated to a negligible risk level.

Joint Chemical Agent Detector (JCAD)

The JCAD is a fully cooperative RDTE effort, chartered to develop a chemical agent detector for a variety of mission requirements and service platforms. The detector will provide warfighters near-real time information on the presence of chemical agents so that miosis or more severe effects can be avoided and not subvert the mission. The project will accommodate the four services' requirements for the following:

- Individual Soldier Detector (ISD)*
- Special Operation Force Chemical Agent Detector (SOF-CAS)*
- Individual Vapor Detector (IVD)*
- Aircraft Interior Detector (AIDET)*
- Shipboard Chemical Agent Monitor Portable (SCAMP)*
- CW Interior Compartment System (CWICS)*
- Improved Chemical Detection System (ICDS)*

Rationale:

- Joint Army, Navy, Air Force, and Marine Corps requirement

Key Requirements:

- Small, lightweight detector capable of detecting presence of chemical agent vapors
- Capable of de-warning, allowing for rapid reduction of protective postures
- Detect, identify, quantify, and warn of presence of even low levels of nerve, blister, and blood agents in vapor form in aircraft and shipboard interiors
- Operated/maintained by ship's force; operate in a shipboard environment

Description:

JCAD will provide a detector or a network of detectors capable of automatically detecting, identifying, and quantifying chemical agents (nerve, blister, and blood) inside aircraft and shipboard interiors. The device must be sufficiently sensitive to warn aircrews before accumulation, over the entire mission, of levels of agent that may cause miosis or more severe effects. JCAD will also provide hand-held monitoring capabilities, protecting the individual soldier, sailor, airman, and marine through the use of pocket-sized detection and alarm.



Shipboard Automatic Liquid Agent Detector (SALAD)

Rationale:

- Navy service-unique requirement

Key Requirements:

- Automatic detection of liquid chemical agents
- Operated/maintained by ship's force
- Operate in a shipboard environment and detect while the ship is underway

Description:



SALAD is an exterior, liquid agent point detection and monitoring system that will detect and alarm in the presence of liquid nerve and blister agents. It consists of a detector unit that uses chemically treated paper, optical scanners, a central processing unit, and alarms (visual and audible) on the bridge and Damage Control Central. Production units will be contracted for based on a performance specification.

Force Medical Protection/Dosimeter ACTD

Rationale:

- Supports Joint Forces Command (JFCOM)

Key Requirements:

- Develop an individually worn sampler that can continuously measure and archive exposure levels of chemical and biological warfare agents using passive sampling methodology (Phase I)
- Include real-time analysis, an alarm to warn the wearer of an immediate chemical hazard, and a trap for biological agents for later analysis (Phase II)

Description:

The Force Medical Protection Dosimeter will be an individually worn sampler that can continuously measure and archive exposure levels of chemical and biological warfare agents. The Phase I of the development will emphasize collection and archiving of exposure to chemical agents using passive sampling methodology. Phase II will include real-time analysis, an alarm to warn the wearer of an immediate chemical hazard, and will trap biological pathogens for later analysis.

Improved detection and identification capabilities will provide greater awareness of immediate chemical exposure risk, more precise identification of exposure, and amount of individual or multiple doses, which will result in improved situational awareness, treatment, and record keeping. Additional payoffs will include the ability to perform real-time analysis of agents, communication of exposure information to command centers, and increased battlefield awareness and intelligence.

Specific challenges include developing technologies to collect, analyze, and differentiate between agents, interferents, and naturally occurring compounds; improving selectivity and sensitivity to agents. Providing communications capabilities and real-time alarm while reducing size and weight will require advances in sampling methods, chemical analysis techniques, and electronics. Developing CONOPs for use of a sampler will require modeling, experimentation, field testing to improve capabilities and increase utility, and analysis to determine value of information of exposure data collected, especially if exposure levels are below threshold effects levels.

Key Milestones:

- 2000: Technical evaluations of Phase II candidate technologies and select technologies for integration into the Phase II sampler. Conduct laboratory testing of Phase I technologies. Begin demonstrations to assess sampler's ability to deal with operational issues identified by Joint Forces Command and other federal partners.
- 2001: Conduct laboratory testing of Phase II technologies. Continue demonstrations to assess sampler's ability to deal with operational issues identified by Joint Forces Command and other federal partners.
- 2002: Deliver residual capability to selected units for further user testing and development. Complete ACTD.

BIOLOGICAL LONG LINE SOURCE RELEASE AND POINT DETECTION

Biological Point Detection is a fully cooperative acquisition effort chartered to develop new biological point detectors and detection systems for the four services. The BIDS P3I effort encompasses development of an integrated system as well as several stand-alone biological detectors. In addition, a Joint Biological Point Detection System (JBPDS) is under development. JBPDS will be a system that can stand alone, or be used in a suite of systems.

**Air Base/Port Biological Detection (Portal Shield)
Advanced Concept Technology Demonstration (ACTD)**

Rationale:

- Requirements identified by the Commander-in-Chief Central Command (CINCCENT) and Commander-in-Chief Pacific Command (CINCPAC)

Key Requirements:

- Field interim systems to sponsoring CINCs that provides rapid, automated biological attack detection, identification and warning (in less than 25 minutes) to high value fixed sites (e.g., ports and airfields)
- Automated “smart” sensor network
- Chemical sensor interfaces for automated biological and chemical network warning and reporting
- In addition to the biological detection system itself, provide the following “leave-behinds” or “residuals” to the fixed sites: an integrated command and control system to assist base personnel in rapid assessment, warning and dissemination of attack data;

unmasking procedures; contamination detection sampling kits, tested tactics, techniques and procedures.

- Demonstrate the military utility of a smart sensor network and exercise operational concepts that may both fill the CINCs immediate needs, and provide valuable “lessons learned” for future systems

Description:

While the BIDS and Long Range Biological Detection System (LR-BSDS) programs have made significant advances towards mitigating the effects of the worst case biological attack scenario (long line source releases—*e.g.*, an aircraft spraying agent along a course tens of kilometers long), DoD still has potential vulnerabilities in protecting those high value fixed sites that will play critical roles in force projection operations. Ports and air-bases, by nature of their commonly known locations and high density of personnel, make lucrative targets for point source releases (*e.g.*, theater ballistic missiles, covert spraying by land and sea vehicles, or even man-portable disseminators). JPO-BD proposed taking available technologies and, through an ACTD, provide a limited number of biological detection systems to warfighting CINCs. The concept has been to build an intelligent network of sensors based on the Navy’s IBAD components, but add to each sensor an automated immunoassay ticket reader for near real time identification of BW agents, location and meteorology modules and “smart” network algorithms to reduce use of consumables and lower false positive rates. The detector network is able to identify 8 biological warfare agents in less than 25 minutes. Site personnel are then able to retrieve samples of the aerosol from the sensors for confirmatory identification of the BW agent. The ACTD will not only provide detection and identification hardware and procedures, it will also provide leave-behinds for post attack actions, such as: contamination detection sampling kits that can provide BW identification of contaminated surfaces such as missile fragments, in 15 minutes; and Enzyme Linked ImmunoSorbent Assay (ELISA) kits for an additional complementary identification capability. User acceptance testing was completed in September 1997. The prototype Mark II network was successfully deployed to Kuwait in support of Operation Desert Thunder in February 1998. Full scale deployment of the ACTD to CENTCOM and PACOM began in 2QFY99. The Joint Chiefs of Staff (JCS) directed the production of five additional Portal Shield networks starting in FY99 and funded their fabrication and support through FY02. PDM1 provided funding for an additional 14 sites in FY01.

Joint Biological Point Detection System (JBPDS)

Rationale:

- Joint Army, Navy, Air Force, and Marine Corps requirement

Key Requirements:

- Automatically detect, identify and warn of the presence of aerosolized biological warfare agents at levels of sensitivity, speed and reliability equal to or better than currently fielded detection systems
- Provide a common suite of biological detection equipment that can be applied to all four services’ designated platforms
- Provide a man-portable version (Air Force and Marine Corps)

- Be operable while on the move (Army and Navy)

Description:



JBPDS is a joint biological point detection system. This developmental system will replace all existing biological detection systems (BIDS, IBAD and Air Base/Port ACTD), and provide biological detection capabilities throughout the services and throughout the battlespace. The common biological detection suite will consist of four functions: *trigger* (detects a significant change in the ambient aerosol in real time), *collector* (collects samples of the suspect aerosol for analysis by the JBPDS, and for confirmatory analysis by supporting laboratories in the Communications Zone and CONUS), *detector* (able to broadly categorize the contents of the aerosol and lend confidence to the detection process; e.g., biological material in the aerosol or not, bacteriological, spore, protein, etc.), and *identification* (provides presumptive identification of the suspect BW agent and increases confidence in the detection process). These four functions will be integrated to allow fully automatic operation, and warning of a positive BW detection. The JBPDS program consists of two phases (Block I and Block II) to allow the fastest possible fielding of a joint

biological detection system, while at the same time preparing to take advantage of the rapid advances taking place in the biological detection/identification, information processing and engineering sciences. JPO-BD awarded an Engineering and Manufacturing Development (EMD) contract in FY97 for the development of Block I JBPDS prototypes for all four services. Production is anticipated to start in 4QFY00, with first unit equipped in March 2002. This joint acquisition strategy will allow for significant economies throughout the RDA process by eliminating duplicative efforts among the services, and greater logistic supportability in joint operations as each service will be able to support the other services' JBPDSs.

Critical Reagents Program (CRP)

Rationale:

- Supports all Services biological detection programs

Key Requirements:

- Provide Total Life Cycle Management for the critical reagents (antibodies, and gene probes and primers) that are necessary to the operation of nearly all DoD biological detection systems.
- Ensure best quality reagents are available in time and in adequate quantities.
- Ensure adequate security and surge capability of critical reagents.
- Put in place a production program for the Handheld Immunochromatographic Assays (HHAs) (*shown*) that are critical to several bio detection programs.



Description:

The Critical Reagents Program will ensure the quality and availability of reagents that are critical to the successful development, test and operation of biological warfare detection systems and medical biological products managed by JPO-BD. The program will maintain an R&D effort to ensure the best possible reagents are available for use against both current and future threats. The program will institute a program wide quality assurance program and address relevant security issues. During the first four years of the program, the CRP will require the greatest level of effort and funding to ensure required reagents are available to support fielded systems (BIDS NDI, P3I, Portal Shield and IBAD), and developmental systems (JBPDS Block I and JBREWS ACTD). The next three years require the development of 12 additional reagents to support the development and fielding of the JBPDS Block II. Outlying years will focus on the development of reagents to detect new and emerging threats and procurement of more effective reagents to replace older stocks.

Small Unit Biological Detector (SUBD)

Rationale:

- Marine Corps service-unique requirement

Key Requirements:

- Low power, portable biological detector tailored to the unique requirements of the Chem/Bio Incident Response Force (CBIRF)
- Include an aerosol collector and an identifier
- Weigh less than 80 lbs, occupy less than 2.5 cubic feet, and require less than 150 Watts of power
- Automatically identify 12 BW agents within 20 minutes and meet or exceed the detection sensitivity of JBPDS

Description:

SUBD will be a low power, portable biological detector to respond to the growing threat of military and terrorist biological attack. The development uses the JBPDS Performance Specification tailored to the unique requirements of the CBIRF. Other biodetection programs such as Portal Shield and JBPDS utilize mature, low risk identification technology, while SUBD is developing second generation technology that will be smaller with more reusable components. The SUBD technology will achieve the same sensitivities as JBPDS but in a smaller, lower power, truly man-portable package with fewer consumables. SUBD technologies may result in technology enhancements for the JBPDS Block II program.

Improved detection and identification capabilities will provide greater awareness of immediate biological agent exposure risk, more precise identification of exposure, and amount of individual or multiple doses which will result in improved situational awareness, treatment and record keeping. Additional payoffs will include the ability to perform real-time analysis of agents, communication of exposure information to command centers, and increased battlefield awareness and intelligence.

Specific challenges include developing technologies to collect and identify agents with an instrument that can be ruggedized for field-use and offer a short response time (<20

minutes). (Laboratory techniques exist but are not portable nor are they suitable for fielding.) Identifier and collector component development and system integration will take place in 2000. Prototype SUBD development will begin in 2001.

STAND-OFF DETECTION AND REMOTE/EARLY WARNING

Joint Service Lightweight Standoff Chemical Agent Detector (JSLSCAD)

The JSLSCAD is a fully coordinated joint service RDTE program, chartered to develop a lightweight standoff chemical detector for the four services. The JSLSCAD will utilize a passive infrared sensor with 360° scanning to satisfy requirements for:

- Lightweight Standoff Chemical Agent Detector (LSCAD)*
- M21 Moving Background*
- Chemical Agent Remote Detection System (CARDS)*
- Stand-off Detector for Armored System Modernization (SD/ASM)*

Rationale:

- Joint Army, Navy, Air Force, and Marine Corps requirement. (Army is lead Service)

Key Requirements:

- Automatically detect nerve, blister, and blood agents at a distance up to 5 km
- Lightweight and employed from manned and unmanned systems
- Capable of being data-linked with centralized hazard information data collection center
- Capable of remote operations; aerial and on-the-move operation

Description:



SCANNER



INTERFEROMETER

JSLSCAD will be capable of scanning 360° x 60°, and automatically detecting nerve or blister agents at a distance up to 5 km. The system will be light, compact and operate from a stationary position or on-the-move. The JSLSCAD Michelson interferometer employs a passive infrared system that will detect presence of chemical agents by completing a spectral analysis of target vapor agent chemical clouds.

JSLSCAD is envisioned for employment on various platforms and in various roles, including fixed site defense, unmanned aerial vehicles, tanks and other vehicles, and on board ships.

Joint Service Warning and Identification LIDAR Detector (JSWILD)

JSWILD is a joint effort chartered to develop a chemical warning and identification system for the quad-services. JSWILD will utilize an active LIDAR sensor to perform rapid agent identification and ranging to satisfy requirement for:

*Laser Stand-Off Chemical Detector (LSCD)
Area Detection System (ADS)
Stand-off Detector (SD)
CB Stand-off Detector (CBSD)*

Rationale:

- Army and Air Force interest

Key Requirements:

- Automatically detect, range, and map CW agents at distances of up to 20 km
- Scan atmosphere and terrain to detect chemical vapors and airborne liquids and particles
- Provide stand-off capability for both fixed site and reconnaissance
- Provide rapid agent concentration mapping

Description:

JSWILD will be a lightweight, vehicle-mountable, contamination monitoring system, which detects and quantifies all types of chemical agent contamination (including agent rain, vapors, and aerosols) in a stand-off mode from a distance of 20 kilometers (km). The JSWILD will operate from fixed sites and ground vehicles. The system has distance-ranging and contamination-mapping capabilities and transmits this information to a battlefield information network.

Biological Remote/Early Warning

The Army's Long Range Biological Standoff Detection System (LR-BSDS) is a legacy system that is being incorporated into what is envisioned to be a family of early warning systems

The Joint Biological Remote Early Warning System (JBREWS) program is intended to give the warfighting commander a significantly shortened decision cycle regarding biological attacks; that is, the commander will see and be able to react to a biological attack much faster, thereby allowing many more personnel to take protective measures before they become exposed to the biological warfare agents. This means that fewer people will become casualties, and fewer people will have to take post-attack medical treatments.

Long Range Biological Standoff Detection System (LR-BSDS) P3I

Rationale:

- Army requirement
- Navy and Air Force interest

Key Requirements:

- Stand-off detection of aerosol clouds out to a range of at least 50 km
- Provides relative concentration, range, location, and tracking of aerosol clouds
- Automated cloud discrimination
- Operating crew reduced to one operator
- UH-60 helicopter-mounted

Description:

LRBSDS uses infrared light detection and ranging (IR-LIDAR) technology to detect, range and track aerosol clouds that are indicative of a BW attack; the LR-BSDS cannot discriminate biological from non-biological clouds. The system, which is approximately 1,240 pounds and 2.3 cubic meters, has three major components: a diode pulsed IR laser transmitter operating at IR wavelengths; a receiver and telescope; and an information processor and display. This program, like BIDS, has been designed in two phases; an NDI phase designed to rapidly field an interim capability, and a pre-planned product improvement (P3I) phase. Three NDI LR-BSDSs have already been fielded to the 310th Chemical Company (USAR). A total of 10 LR-BSDS P3I systems will be procured from FY00 to FY02 (3 per company with 1 training system). The NDI system is able to detect and track man-made aerosols out to 30 km, but is non-eyesafe out to about 2.5 km. The P3I LR-BSDS will be eyesafe, will have a longer operating range (50 km), and will be easier to operate. The first P3I LR-BSDSs will be fielded to the 7th Chemical Company (Biological Detection) in 1QFY01.

The Joint Program Office for Biological Defense is leveraging the benefits of the ACTD program to greatly accelerate the development of the next generation of remote/early warning systems (i.e., systems other than the LR-BSDS). This new generation of detectors is referred to as the Joint Biological Remote/Early Warning System (JBREWS). JPO-BD is managing a JBREWS ACTD that will address selected CINCs' needs, and will better refine our requirements and concepts regarding remote/early warning systems.

Joint Biological Remote Early Warning System (JBREWS)

Rationale:

- EUCOM requirement (ACTD)
- All services interest (ACTD and objective system)

Key Requirements:

- JPO-BD is sponsoring a series of concept studies, including a Study Advisory Group (SAG) composed of CINC, Service, and Joint NBC Defense Board representatives. This cooperative effort will define the requirements for the JBREWS ACTD

- The ACTD formally started in FY98, with fielding of ACTD systems to the EUCOM CINC sponsor around FY01
- Lessons learned from the JBREWS ACTD will assist the SAG in developing/refining its requirements document for the JBREWS objective system
- JBREWS objective system is expected to start fielding around FY05

Description:

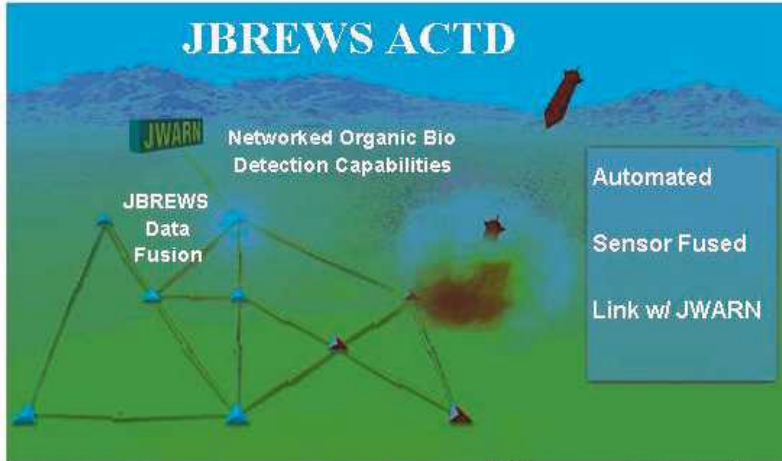

JBREWS is planned to become a “system of systems.” That is, it may have legacy systems—BIDS, JBPDS, and standoff LIDAR systems such as the LR-BSDS—integrated with short range biological standoff detection systems (SR-BSDS) and dense arrays of miniaturized, rugged point detectors into a distributed network of sensors. The miniature sensors will possess



only one or two of the functions that the much more robust JBPDS will have. The point

detectors may be employed in a variety of ways: carried on vehicles, emplaced by hand around unit/site perimeters, remotely emplaced by aircraft, or possibly even delivered by artillery or rocket systems to project the sensors into contested or enemy controlled areas. The systems need to be networked to provide the greatest confidence of accurate detection and rapid warning. They will need to be deployed and distributed widely and in high numbers to ensure point releases are not missed.

NBC RECONNAISSANCE

Joint Service Light NBC Reconnaissance System (JSLNBCRS)

The Joint Service NBC Reconnaissance program is a coordinated U.S. Army, U.S. Air Force and Marine Corps effort which will yield improved reconnaissance capabilities for both heavy and lightweight vehicle platforms. It will satisfy requirements for:

- M93A1 NBC Reconnaissance System (NBCRS) Production*
- M93A1 P3I Block II*
- Light NBC Reconnaissance System (LNBCRS)*

Rationale:

- Joint U.S. Army, U.S. Air Force, and Marine Corps Requirements

Key Requirements:

- Stand-off and point detection from vehicle mounted or dismounted operations
- Chemical standoff detection
- Detection while on-the-move capability from speeds of 0-45 kph
- Biological point detection and identification
- A dismountable, handheld, self-contained chemical point detection capability
- Radiological detection capability (vehicle mounted or dismounted operations)
- Collective protection
- Environmental Conditioning Unit capable of providing climate conditioning for the crew and equipment
- Overpressure protection from all known agents

Description:

The JSLNBCRS (*shown*) will provide a premiere vehicle for accurate, rapid NBC combat hazard information by verifying the absence of, finding, mapping, and marking radiological, biological, and chemical hazards. The JSLNBCRS will be an integration of advanced NBC detection and analysis equipment suited for Marine Air-Ground Task Forces (MAGTFs), U.S. Air Force tactical forces, and U.S. Army Light Contingency Forces.



WARNING AND REPORTING

Joint Service Warning and Reporting Network (JWARN) (FUE FY 99)

Rationale:

- Army, Navy, Air Force, and Marine Corps requirement

Key Requirements:

- Capable of interfacing with all NBC detectors and sensors
- Capable of interoperability with all service command and control systems
- Capable of generating NBC reports
- Capable of automatic transmission of NBC alarm and data
- Capable of vehicle operation

Description:

The Joint Warning and Reporting Network (JWARN) is an automated Nuclear, Biological, and Chemical (NBC) Information System. The JWARN will be essential for integrating the data from NBC detectors and sensors into the Joint Service Command, Control, Communication, Computers, Information and intelligence (C⁴I²) systems and

networks in the digitized battlefield. JWARN will provide the Joint Force a comprehensive analysis and response capability to minimize the effects of hostile NBC attacks or accidents/incidents. JWARN will also provide the Joint Forces with the operational capability to employ NBC warning technology that will collect, analyze, identify, locate, report and disseminate NBC threat and hazard information. JWARN will be located in command and control centers at the appropriate level defined in Service-specific annexes and employed by NBC defense specialists and other designated personnel. It will transfer data automatically from and to the actual detector/sensor/network node and provide commanders with analyzed data for decisions for disseminating warnings to the lowest echelons on the battlefield. It will provide additional data processing, production of plans and reports, and access to specific NBC information to improve the efficiency of NBC personnel assets.

DARPA Programs

Tissue-Based Biosensors Program

Accomplishments:

- B-cell sensor prototype system fabricated and tested. Simulant detection down to 200 particles in solution reported.
- Engineered liver and vascular endothelial cells into chip format. Genetically induced fluorescent reporter elements for cell stress into liver cells for detector system.
- Used green fluorescent protein to optically tag transcriptional upregulation cellular events (NFkB) for FLUORO-tox prototype high throughput cell sensor system
- Initiated fluorotox database for data mining cell responses to unknown pathogens.
- Demonstrated 4 order magnitude increase in cell survival by introducing extremophile genes into labile cells.
- Defined mechanism of action of operational neurotoxicants from engine lubricant in neuronal based hand held biosensors.

Description:

DARPA is exploring the use of biological cells and tissues as detector components for sensor devices that will report on chemical and biological toxins. Cells and tissues can be used to report on the functional consequences of exposure (mechanism and activity) to a wide spectrum of chemical and or biological toxins, whether they are living or dead, or whether they have been bioengineered and are currently undetectable by other means (antibodies, nucleic acid sequencing). Technical issues that are being addressed in the program include, (1) the fabrication of biocompatible matrices and interfaces for the long-term retention of cell and tissue function, (2) pattern recognition from critical pathways responsible for the interfaces for the long-term retention of cell and tissue function, (2) pattern recognition from critical pathways responsible for the processing of toxins, (3) sampling strategies to accurately extract and present the toxin from air, liquid, or solid samples, and (4) systems integration into a functional device. The current focus of the program is on the use of neuronal and immunological cells and tissues as detectors for such devices. Engineering of cells and tissues of these origins, including stem cells, is

proceeding in order to optimize sensor performance requirements and fabricate prototype devices for testing evaluation.

Microfluidic Molecular Systems Program

Accomplishments:

- Demonstrated discrimination of 0.4% differences in cell impedance using micromachined dielectrophoresis system
- Demonstrated on-chip circulation—controlled transport of target liquids through combination of integrated fluidic channels and reaction components
- Demonstrated microscale enabled immunoassay with enzyme labelers to replace conventional optical label
- Demonstrated microfan and filter system to capture airborne particulates into liquid for input to detection system
- Demonstrated efficient transport of DNA over cm distances using electrophoretic confinement and transport through electrophoretic vias
- Demonstrated a multi-channel device that is able to carry out six independent assays simultaneously using a single point detector.

Description:

Micro total analysis systems are being developed through focused research on microfluidic, chip-scale technologies. Automated sample collection and sample preparation are key front-end processes for early biological agent detection, whether it is by immunoassays, DNA assays, or tissue-based assays. To scale down these processes into miniaturized, multiplexed detection systems, microfluidic chip-scale components need to be developed. Microfluidic components/devices currently being developed by DARPA include chip-scale micropumps/valves, particle separation filters, fluidic interconnects, fluidic manipulation of hybridized microbeads, controlled mixing/dosing etc.... Several demonstrable handheld prototypes, such as a programmable microfluidic system for remote sensors, are currently being tested.

Pathogen Genome Sequencing Program

Accomplishments:

- Initiated sequencing of the pathogenic bacteria *Brucella abortus*, *Brucella melitensis*, *Brucella suis* and their non-pathogenic near neighbor *Ochrobactrum anthropi*
- Initiated sequencing of the non-pathogenic bacterium *Bacillus cereus*, the near neighbor of the pathogenic bacterium *Bacillus anthracis*
- Initiated sequencing of the non-pathogenic near-neighbor bacterium *Yersinia pseudotuberculosis*, the near neighbor of the pathogenic bacterium *Yersinia pestis*.

Description:

DARPA is committed to sequencing the genomes of high threat biowarfare agents. This effort, undertaken with broad community interaction, will support Biological Warfare Defense research activities sponsored by DARPA and is intended to satisfy the needs of Department of Defense components, the Intelligence Community, and other governmental organizations. Interest is focused on BWD pathogens, and non-pathogenic near neighbors

thought to be important to establish a basis for low false alarm detection and identification. The work also contributes to the development of advanced unconventional pathogen countermeasures.

Protection Program

Accomplishments:

- Built first prototype of water disinfection pen (size of a thick fountain pen) based on an electrochemical cell. The pen was able to create a mixed oxidant solution that is more potent than tablets used nowadays by the forces: the mixed oxidant pen was able to destroy many waterborne pathogens to at least 3 to 4 log removal.
- Demonstrated that harmonic pulsing of a reverse osmosis membrane increases water flux through the membrane and decreases the total dissolved solids.
- Built first prototype water distillation unit the size of a coffee mug that distills water. The distillation unit was able to desalt seawater without clogging. Tests on waterborne bugs show at least a 4 log removal. The water generation rate was measured to be approximately 0.3 liters in 5 minutes.
- Built first generation air purification unit to destroy airborne pathogens by thermocatalytic destruction. The destruction efficiencies for various air pathogens and simulants in the high 90% range. The goal is to get towards at least 99.999% removal rates.
- Began work on advanced carbon surface treatments to improve adsorption capacity and kinetics.

Description:

There are two related programs currently ongoing within DARPA that further enable the individual warfighter by providing significantly more mobile and flexible water purification and desalinization systems and better air filtration media. The intent is to demonstrate highly efficient, smaller, lighter, high water through-put technologies for water purification and desalinization, and to explore pioneering air filtration schemes that have an acutely high utility for the DoD enabling new mission scenarios that are critical to the changing battlefield environment. The water desalinization and purification systems would meet Army Operational Requirements (i.e., effectively treat salt/brackish water and nuclear, biological and chemical contaminated water, purify 0.2 liter water per minute, weigh less than 2 lbs., etc.). The proposed man-portable water units will be multifunctional in that they can be used for several functions, such as water purification, power generation and camp stoves. Work in air purification develops simple air filtration and purification systems for the individual that provide significant improvements over the current charcoal filter gas mask technology (which have remained virtually unchanged for over 20 years). The intention is to develop air purification systems for collective protection that will require much less maintenance and greater personal safety than current based-carbon recirculating filters.

(INTENTIONALLY BLANK.)

Annex B

Non-Medical Protection Programs

SECTION 1: FIELDED AND PRODUCTION ITEMS

RESPIRATORY

M17A2 Protective Mask



The M17A2 Protective Mask consists of a natural blend rubber face piece; two activated charcoal filters mounted within cheek pouches; a voicemitter to facilitate communications, a drinking tube; eyelens outserts to protect the mask's integral eyelens and reduce cold weather fogging; an impermeable hood; and a carrier for the mask, its components, and medical items (such as the Nerve Agent Antidote Kit). The Army and Marine Corps are replacing this mask with the M40 series protective masks. The Navy has replaced the M17A2 protective mask with the MCU-2/P. The Air Force replaced it with the MCU-2A/P, but retained limited quantities of extra small M17A2s for those situations where the MCU-2A/P short is too large.

ABC-M24 Aircraft Protective Mask

This protective mask provides the wearer protection from NBC aerosols/vapors both in aircraft, and on the ground. The mask consists of: wide view, clear plastic lens embedded in a butyl rubber face blank; an integral microphone; eyelens outserts; carrying case; anti-fog kit; and a hose-mounted filter canister. The mask has a microphone connection to fit the aircraft communications systems. The M24 has an adapter that allows coupling to the aircraft's oxygen supply system. The M24 is being replaced by the M45 mask.

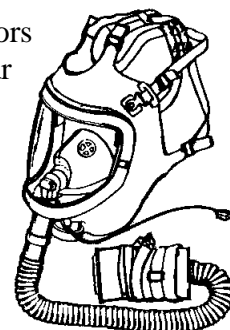

M25A1 Tank Protective Mask

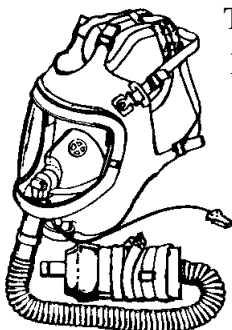

This protective mask provides the wearer protection from NBC aerosols and vapors both in the vehicle/aircraft, and on the ground. The mask consists of: wide view, clear plastic lens embedded in a butyl rubber face blank; an integral microphone; eyelens outserts; carrying case; anti-fog kit; and a hose mounted filter canister. The mask has a microphone connection to fit the armored vehicle communications systems. The M25A1 has an adapter that allows it to be coupled to the tank's filtered and temperature controlled Gas Particulate Filtration Unit (GPFU). The M25A1 is being replaced by the M42/M42A1/M42A2 protective mask.



MCU-2A/P Protective Mask

The MCU-2A/P provides eye and respiratory protection from all chemical and biological agents as well as radioactive particulate material. The mask uses a replaceable, standard NATO filter canister which is mounted on either side of a wide-view optical quality visor. The mask provides improved fit, comfort, and visibility relative to earlier masks, and includes a drinking tube for attachment to the standard canteen, and electronic voicemitter connections for improved communications.

M40/42 Series Protective Mask

The M40/42 series protective masks provide eye-respiratory face protection from tactical concentrations of CB warfare agents, toxins and radioactive fallout particles. Each mask consists of a silicone rubber face piece with an in-turned peripheral face seal and binocular rigid lens system. The facepiece is covered with a chlorobutyl/EPDM second skin to provide optimum liquid agent protection for the masks. It accommodates NATO standard canisters, which can be worn on either cheek of the mask.

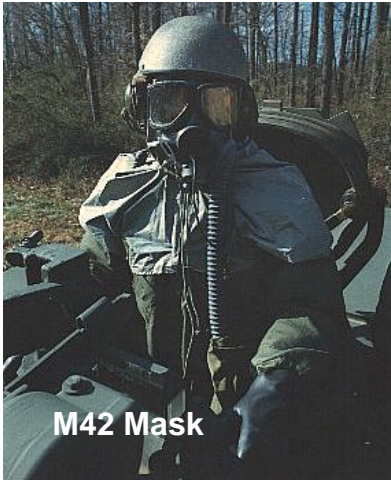

The M40 series is designed for the individual dismounted ground warrior, while the M42 series is designed for combat vehicle crewmen. Recent improvements include a universal second skin, making the mask compatible with JSLIST and Saratoga overgarments, and ballistic/laser protective eye lens outserts. The mask facepiece has been made a spare part, which has resulted in a significant operation and support cost savings. Use of modular parts permits the M40 series to be used in both the M40 and M42 configuration. This has resulted in significant operational and support cost savings.

M43 Protective Mask

The M43 Aviator Mask consists of a form-fitting face piece with lenses mounted close to the eyes; an integral CB hood and skull-type suspension system; an inhalation air distribution assembly for air flow regulation, lenses and hood; and a portable motor/blower filter assembly that operates on either battery or aircraft power. The M43 Type I was developed for the AH-64 aviator and is compatible with the AH-64 Integrated Helmet and Display Sight System and the Optical Relay Tube. The M43 Type II is intended for the general aviator.



M45 Aircrew Protective Mask (ACPM) (FUE FY98)



The M45 Air Crew Protective Mask is specially designed to meet the requirements of helicopter and special crews. It does not require power or forced air to provide CB protection; it provides compatibility with helicopter optical systems, aircraft displays and night vision devices; and has reduced weight, cost and logistical burden when compared to the M48 series of mask. The ACPM has close fitting eyelenses mounted in a silicone rubber facepiece with an in-turned peripheral seal, a detachable hood system, and utilizes the standard NATO canister. The M45 will replace the M43 (Type II) and the M24 aviators mask.

M48 Protective Mask - Production

The M48 is the third generation M43 series masks. The M48 mask replaces the M43 Type I mask and will be the only mask for the Apache aviator for the foreseeable future. The M48 mask consist of a lightweight motor blower, a new hose assembly, a web belt, the mask carrier, facepiece carrier, eyelens cushions, and the facepiece of the M43A1.



Aircrew Eye/Respiratory Protection (AERP)

The AERP (replaces the MBU-13/P system for aircrews) is a protective mask which enables aircrews to conduct mission operations in a chemical-biological environment. The AERP system includes a protective hood assembly with a standard MBU-12/P mask, an intercom for ground communication, and a blower assembly that provides de-misting. The blower is stowed during flight operations on a bracket that is mounted inside the aircraft.

CB Respiratory System (A/P22P-14(V) 1, 2, 3, & 4) NDI

The CB Respiratory System is a self-contained protective ensemble designed for all forward deployed rotary wing (Version 1 for USN) and fixed wing (Version 2-4 for USN and USMC) aircrew. The design incorporates a CB filter, dual air/oxygen supply and a cross-over manifold with ground flight selector switch to provide filtered air for hood ventilation, and filtered air for oxygen for breathing. The system provides enhanced protection and offer anti-drown features.

A/P22P-14(V)1 Non-Oxygen Assembly for Rotary Wing



ANCILLARY MASK EQUIPMENT

M41 Protection Assessment Test System



The M41 Protection Assessment Test System (PATS) enhances operational capability by validating proper fit of the mask to the face of the individual. The PATS is a new capability that provides a simple, rapid, and accurate means of validating the face piece fit and function of protective masks.



Voice Communication Adapter

The Voice Communication Adapter (VCA) is a low risk program providing additional capability to the M40/42 mask. The VCA is a joint program between the USMC and US Army.

Universal Second Skin



The Universal Second Skin is one of the components of a pre-planned product improvement (P3I) in the M40/M42 series mask. The Universal second skin provides liquid agent protection for the mask faceblank material. This program is a Joint U.S. Army/U.S. Marine Corps effort. Both Services developed prototype designs and, after field user and human engineer testing, the Marine Corps design was selected. The Air Force is developing a second skin for the MCU-2A/P.

BATTLEFIELD PROTECTIVE SUITS

Battle Dress Overgarment (BDO)

The BDO is a camouflage patterned (desert or woodland), two piece, air permeable overgarment typically worn over the duty uniform. The overgarment material consists of an outer layer of nylon cotton, and an inner layer of activated charcoal impregnated polyurethane foam. The BDO provides protection against chemical agent vapors and liquid droplets, biological agents (to include toxins), and radioactive alpha and beta particles. The BDO is issued in a sealed vapor-barrier bag that protects the garment from rain, moisture and sunlight. The BDO provides 24 hours of chemical agent protection once contaminated and has a field durability of 22 days (extendable to 30 days at the discretion of Field Commanders).



JSLIST Overgarment

The JSLIST Overgarment will provide 24 hour protection after 45 days of wear and 6 launderings. The liner currently is based upon activated carbon bead technology, replacing the bulky activated carbon foam technology in previous garments. The JSLIST Overgarment is a two-piece jacket and trouser design with an integrated hood compatible with respective Service masks and second skins. It will be worn as an overgarment for the duty uniform or as a primary garment over underwear depending upon the environment and mission.



Chemical Protective (CP) Suit, OG MK-III (Navy Suit)



The Chemical Protective Overgarment (CPO) protects the wearer against all known chemical and biological agents which present a percutaneous hazard. The suit consists of a smock and separate pair of trousers, and is sized to accommodate the 5 percentile female through the 95 percent male ratio. This garment will be replaced Navy-wide by a superior suit developed under the auspices of the Joint Service Lightweight Integrated Suit Technology (JSLIST) program. The Mark III chemical, biological, radiological (CBR) suit protects against chemical agent vapors, aerosols, droplets of liquid, and biological agents.

CP Suit, Saratoga (USMC)

Like the BDO, the SARATOGA CP Suit is an air permeable, camouflage patterned overgarment. Instead of carbon impregnated foam, SARATOGA uses spherical, activated carbon adsorbers immobilized in the liner fabric. This system allows for a lighter, cooler garment, which is launderable. The Saratoga provides a 24 hour protection period and has a durability of 30 days continuous wear.



CWU-66/P Aircrew Ensemble - Production (FUE FY96)



The CWU-66/P, a one-piece flightsuit configuration, provides 24-hour protection against standard NATO threats. It is made with Von Blucher carbon spheres, and is less bulky than prior ensembles. It offers a reduced thermal load burden and is compatible with aircrew life support equipment.



Chemical Protective Undergarment (CPU)

The CPU is a two-piece lightweight undergarment made of a non-woven fabric containing activated charcoal. When worn under the combat vehicle crewmen (CVC) coverall or battle dress uniform (BDU), the CPU provides 12 hours of protection and is durable for 15 days.

SPECIALTY SUITS

Joint Firefighter Integrated Response Ensemble (JFIRE)

JFIRE is a joint effort between the Air Force (lead agency) and the Army. The JFIRE Program has developed an ensemble that will protect the military firefighters IAW National Fire Protection Association (NFPA) standards and provide CB protection during firefighting operations in a CB environment. JFIRE leverages the JSLIST overgarment for chemical protection, to be worn under aluminized proximity firefighting outergear and with a switchable filtered/supplied air mask with chemical warfare (CW) kit. A Commercial Off-the-Shelf (COTS) glove that can be used for both fire and CB protection will replace the need for CB gloves to be worn under standard proximity gloves. JFIRE meets several key requirements, including (1) providing 24 hours of CB agent protection against 10 g/m² liquid agent, (2) providing firefighters CB protection in both structural and crash fire fighting/rescue operation, (3) allowing firefighters to use mission essential tools and equipment in a CB environment, (4) providing resistance to water and all standard fire fighting chemicals (foam, CO₂, aircraft POL), and (5) is capable of being donned in 8 minutes.



Suit Contamination Avoidance Liquid Protection (SCALP)

The SCALP can be worn over standard chemical protective garments to provide 1 hour of protection from gross liquid contamination. The SCALP, which consists of a jacket with hood, trouser and booties, is made from a polyethylene-coated Tyvek™ material.

Interim-Self Contained Toxic Environment Protective Outfit (STEPO-I)

Approved as an interim system for 2-hour depot operations in Immediate Danger to Life and Health (IDLH) environments. It consists of encapsulating suit made of butyl rubber-coated nylon with a polycarbonate visor. Respiratory protection is provided by one of two options—tethered clean air supply or a self-contained rebreather worn as a back-pack. Cooling is provided by an ice vest worn underneath the suit.

Self-Contained Toxic Environment Protective Outfit (STEPO)

STEPO provides OSHA level A protection for Army Chemical Activity/Depot (CA/D), Explosive Ordnance Disposal (EOD) and Technical Escort Unit (TEU) personnel. The STEPO is a totally encapsulating protective ensemble for protection against chemical and biological agents, missile/rocket fuels, POL, and industrial chemicals for periods up to four hours. The ensemble incorporates two types of NIOSH approved self-contained breathing systems (one hour and four hour configurations) and a tether/emergency breathing apparatus option, a battery powered Personal Ice Cooling System (PICS), a hands-free communications system, and standard Toxicological Agent Protective (TAP) boots and gloves. The suit is capable of being decontaminated for reuse up to 5 times after chemical vapor exposures. STEPO shares common, modular components with the ITAP and JFIRE ensembles simplifying logistics and reducing costs.



Improved Toxicological Agent Protective (ITAP)



ITAP replaces the M3 TAP ensemble. ITAP enhances existing capabilities by increasing personal protection and reducing the thermal burden on the wearer. ITAP also provides skin and respiratory protection both during peacetime and wartime for short term operations in Immediately Dangerous to Life and Health (IDLH) toxic chemical environments (up to 1 hr), emergency life saving response, routine Chemical Activity operations and initial entry and monitoring. ITAP shares common, modular components with the STEPO and JFIRE ensembles, simplifying logistics and reducing costs.

ITAP provides splash and vapor protection against potential exposure to liquid agent when worn as a system—requirements: 10g/m² HD, VX, GB, L agent challenge for 1 hours. It provides an optional Personal Ice Cooling System (PICS), and is functional as a system where temperatures range from 0° to 100°F when used with the cooling system.

The ITAP suit and overhood are capable of being decontaminated for a minimum of 5 reuses, 2 hours per use (1 hour at IDLH), after vapor and particulate contamination. After liquid contamination ITAP suit will be decontaminated and held for disposal.

The ITAP fabric is self-extinguishing meeting NFPA 1991. The fabric is also static dissipative and does not hold a charge sufficient to set off munitions and explosives in accordance with current Explosive Safety Board requirements. The fabric is light in color to reduce operator solar heat load, and is capable of being stored within the temperature range of 0° to 120°F. ITAP has a minimum shelf life of 5 years.

PROTECTIVE ACCESSORIES

Green Vinyl Overboots /Black Vinyl Overboots (GVO/BVO)

The GVO/BVO are fitted vinyl overshoes that are worn over the combat boots to provide chemical agent protection and/or moisture vapor protection during wet weather. The impermeable GVO/BVO provide protection against chemical agents for 12 hours and are durable for up to 14 days.



Multipurpose Overboot (MULO)
(JSLIST Boots)

The MULO is a joint service program under the auspices of the JSLIST program and will replace the GVO/BVO. It is made of an elastomer blend and will be produced by injection molding. It is designed for wear over the combat boot, jungle boot, and intermediate cold/wet boot. The MULO provides more durability, improved traction, resistance to POLs and flame, and better donning and doffing characteristics over standard footwear.

Chemical Protective (CP) Gloves

The CP glove set consists of a butyl-rubber outer glove for protection from chemical agents, and a cotton inner glove for perspiration absorption. CP outer gloves come in three thicknesses: 7, 14, and 25 mil. The 7 mil glove is used by personnel who require a high degree of tactility, such as medical and personnel engaged in electronic equipment repair. The 14 mil glove is used by personnel like aviators and mechanics, in cases when good tactility is necessary and stress to the glove is not too harsh. The 25 mil glove is used by personnel who require a durable glove to perform close combat tasks and heavy labor. The 14 and 25 mil glove sets provide protection for at least 24 hours. The 7 mil glove set should be replaced within 6 hours of exposure to a chemical agent.



COLLECTIVE PROTECTION EQUIPMENT

M51 Protective Shelter, CB

The M51 shelter is a trailer-mounted system that consists of the following major components: a 10-man shelter, a protective entrance, and a support system. The shelter and protective entrance support themselves through air filled ribs. The protective entrance minimizes carry-over of vapor contamination from outside to inside the shelter, and paces entries to the shelter to prevent

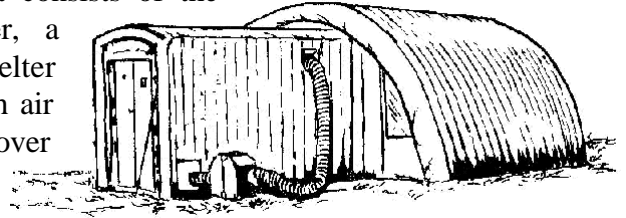

loss of shelter over-pressure. The air handling system is permanently mounted in the trailer, and provides forced, filtered, and environmentally conditioned air to the shelter. The M51 is mostly used by battalion aid stations and other medical units. It can also be used as a temporary rest and relief shelter. The M51 utilizes outdated technologies and is being replaced with CBPS. Very few M51s remain serviceable and logistically supportable. This system can be erected and employed by 4–6 personnel in approximately one hour. This system provides heat stress relief from the effects of MOPP for 12–14 personnel.

M20/ M20A1 Simplified Collective Protective Equipment

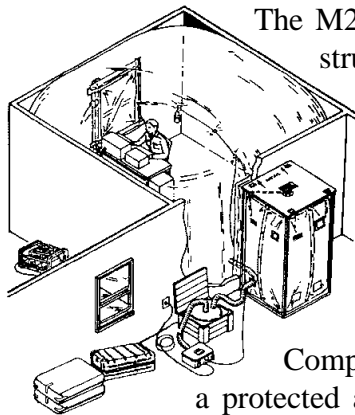

The M20/M20A1 SCPE is used to convert an interior room of an existing structure into a positive overpressure, NBC collective protection shelter where individuals can perform assigned missions without wearing the protective mask and overgarment. The system consists of a liner, protective entrance, filter canister, and support kit. The SCPE is a low cost method of transforming a room in an existing structure into an NBC collective protection shelter for command, control and communication (C³), medical treatment, and soldier relief functions. M20A1 is a room liner for existing shelters.

Components include a CB vapor resistant polyethylene liner that provides a protected area in an existing structure; a collapsible, protective entrance that allows entry to/exit from the protected area; a hermetically sealed filter canister, which provides filtered air to both the liner and the protective entrance; and a support kit, which contains ducting, lighting, sealing and repair material and an electronically powered blower.

M28 Simplified CPE (SCPE)

The M28 SCPE is a low cost method of transforming a room of an existing structure into an NBC collective protection shelter for command, control and communication (C³), medical treatment, and soldier relief functions. M28 is a liner for the TEMPER tent. Components include a CB vapor resistant polyethylene liner that provides a protected area in an existing structure; a collapsible, protective entrance that allows entry to/exit from the protected area; a hermetically sealed filter canister, which provides filtered air to both the



liner and the protective entrance; and a support kit, which contains ducting, lighting, sealing and repair material and an electronically powered blower. A pre-planned product improvement (P³I) program to the M28 SCPE provides liquid agent resistant liners, protective liners for tents, interconnectors, and an interface with environmental control units. The improved SCPE also allows more people to enter at one time, and protects hospitals under tents.

Chemically Protected Deployable Medical System (CP DEPMEDS) - Development/Production

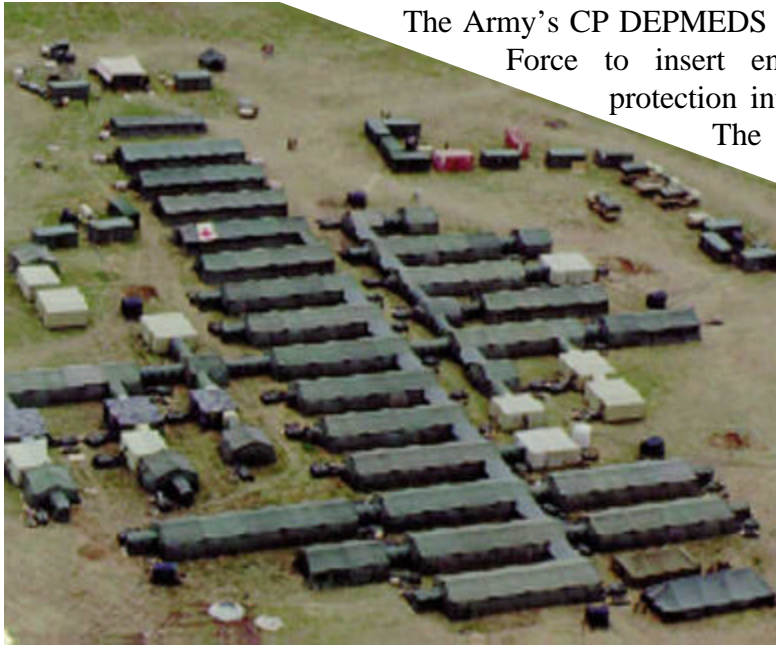

The Army's CP DEPMEDS program is a joint effort with the Air Force to insert environmentally controlled collective protection into currently fielded hospital shelters.

The requirement is to be able to sustain medical operation for 72 hours in a chemical contaminated environment. Environmentally-controlled collective protection is provided through the integration of M28 SCPE, chemically protected air conditioners, heaters, water distribution and latrines, and alarms systems. M28 SCPE provides protection to existing TEMPER Tents and passageways within the hospital. DEPMEDS ISO shelters are protected through the replacement

of existing shelter seals with those that are CB protected. The Field Deployable Environmental Control Unit provides air conditioning and the Army Space Heater provides heating. Both environmental control units are chemically protected through the addition of a CB kit. To sustain approximately 500 patients and staff, chemically protected latrines and water distribution systems have been developed.

Chemically/Biologically Hardened Air Transportable Hospital (CHATH) – Production

The Air Force's CHATH program is a joint effort with the Army to enable medical personnel to deploy and setup in chemical and biological threat areas and operate in chemically and biologically active environments. CHATH allows personnel to perform their hospital duties in a Toxic Free Area. CHATH upgrades TEMPER-based Air Transportable Hospitals (ATHs) retaining the same medical equipment and personnel. CHATH uses existing and modified U.S. Army equipment to line the current ATH tents providing an airtight shelter. The Human Systems Program Office (HSC/YA) developed a Chemically/biologically Hardened Air Management Plant (CHAMP).



The CHAMP filters chemically and biologically contaminated air, and recirculates and filters interior air to maintain a clean hospital standard, provides heating, cooling, and over-pressurization to the hospital. The CHAMP can be operated from standard electrical sources or from its own internal generator. The CHAMP comes equipped with an Automatic Transfer Switch (ATS) to maintain power after Base power is shut off. The ATS starts the Diesel generator after three seconds of power interruption. The CHAMP allows the CHATH to be staged near warfighters in the field in a bare base environment. The CHATH can be deployed in increments of 10, 25, and 50 beds. This flexibility of the CHATH system helps ensure the best medical care as near the crisis area as possible. Implementation of the Aerospace Expeditionary Force concept and resulting changes in Air Force Medical Service support concept of operations during FY99 has altered plans to field CHATH systems during FY99-FY00.

Shipboard Collective Protection System - Production

Shipboard CPS is an integral part of the HVAC systems on new construction ships. CPS provides each protected zone on the ship with filtered air at an over-pressure of 2.0 inches water gage. CPS is modular and is based on a Navy-improved version of the 200 cfm M56 filter. CPS includes filters, filter housings, high pressure fans, airlocks, pressure control valves, low pressure alarm system, and personnel decontamination stations.

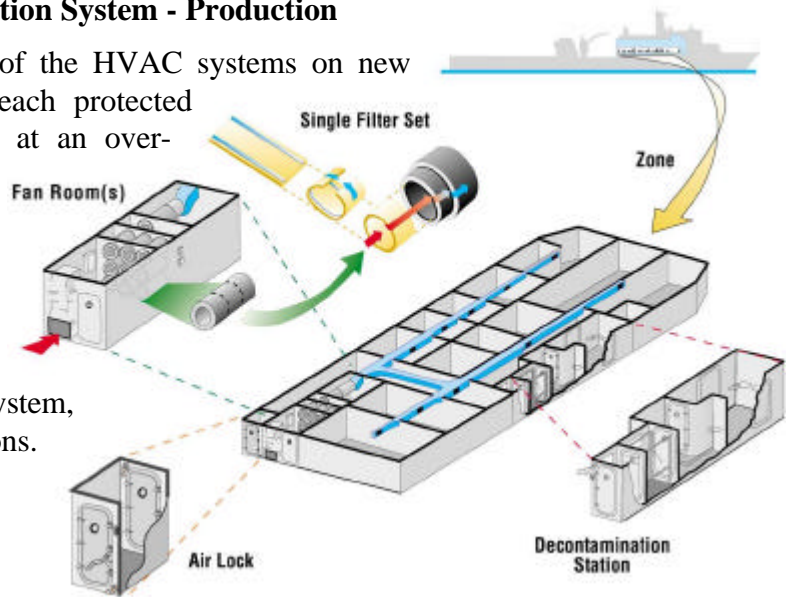

Selected Area Collective Protection System - Production

Selected Area CPS (SACPS) is designed to be easily adaptable to current ships to provide selected spaces (i.e., command and control, berthing areas, etc.) with an affordable CPS system. SACPS is modular and is based on a Navy-improved version of the 200 cfm M56 filter. SACPS is easily integrated into the ship's existing HVAC system, and includes filters, filter housings, a high pressure fan, an airlock, a pressure control valve, and a low pressure alarm system.

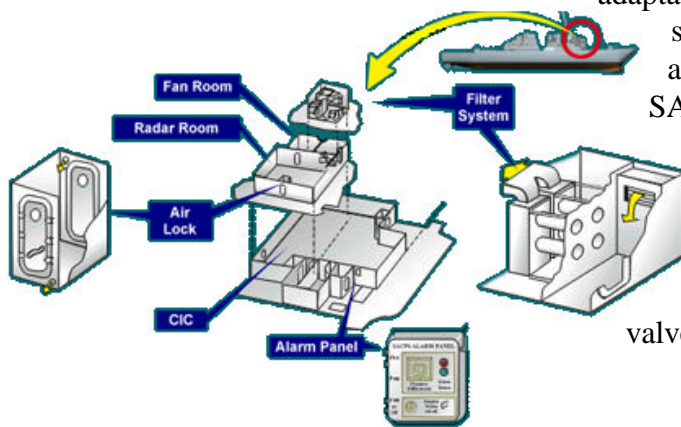

CB Protected Shelter (CBPS) - Production



CBPS is a highly mobile, rapidly deployable shelter system designed to be used for Echelon I and II forward area medical treatment facilities as a replacement for the M51. The system is self-contained and self-sustaining. The CBPS consists of a dedicated M1113 Expanded Capacity Vehicle (ECV), a Lightweight Multipurpose Shelter (LMS)

mounted onto the vehicle, a 300 square foot airbeam supported CB protected shelter, and a High Mobility Trailer with a 10kW tactical Quiet Generator Set. The ECV and LMS transports a crew of four and their gear. All medical equipment required for the shelter is transported in the LMS or on the trailer. The CB shelter is rolled and carried on the rear of the LMS during transport. The CBPS is operational within 20 minutes with a crew of four. All power required to support operations is provided by the ECV engine or with the 10kW generator for limited power. The system is environmentally conditioned by a hydraulically powered environmental support system, which provides filtered air, heating, air conditioning, and electrical power. The system is presently in limited production with fielding scheduled to initiate in 3QFY00.

Portable Collective Protection System

The transportability and ease of use of the Portable Collective Protection System (PCPS) permit mobility and flexibility in chemically or biologically contaminated areas. PCPS can be erected by four Marines within 30 minutes wearing MOPP 4 gear. The protective shelter is divided into a main area and two smaller compartments; the entry area, and the storage area. When overpressure is applied, the protective shelter provides protection from liquid and vapor chemical and biological agent. An airlock (protective entrance) allows purging of possible chemical agent vapors and additional decontamination of personnel entering the main area.

GENERIC NBC FILTERS AND COLLECTIVE PROTECTION FILTRATION SYSTEMS

Generic, high volume air flow NBC filters, and CP filtration systems exist that are currently installed on a wide variety of applications. These CP systems are modular and have been applied to numerous vehicles, vans, mobile shelters, and fixed sites.

GENERIC NBC FILTERS

NBC filters are used to remove Nuclear and Biological particulates and Chemical aerosols and vapors from the air supplied to collective protection systems.

M48/M48A1

The 100 cubic foot per minute (cfm) filter is used in the M1A1/A2 Abrams tank, M93 Modular Collective Protection Equipment (MCPE), CB Protected Shelter, and Paladin Self Propelled Howitzer.

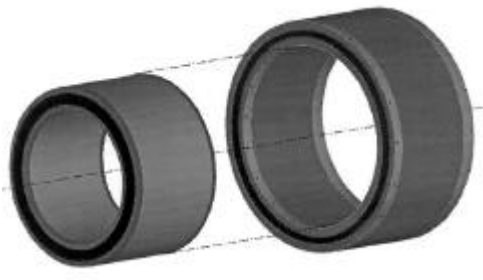

M56

The 200 cfm filter is used as the basic filter set in the MCPE and in Naval applications. It can be stacked to obtain filtration of higher air flow rates.

600 cfm and 1200 cfm Stainless Steel Fixed Installation Gas Filters

These filters are used in fixed site applications where high volumes of air flow are required. They can be stacked to provide higher NBC filtered air flow rates. Particulate filter would be procured separately.

GENERIC NBC CP FILTRATION SYSTEMS

The following are modular NBC CP filtration systems which are applied to a wide variety of applications. They consist of an NBC filter, motor/blower unit, housings, and integration housings/ductwork. Some can be integrated into environmental control equipment.

M8A3 Gas Particulate Filter Unit (GPFU)

The 12 cfm system provides air to armored vehicle crewman ventilated facemasks, *i.e.*, M42A1/A2. Used in M113 Armored Personnel Carrier variants and USMC AAVP7A1 amphibious vehicle.

M13A1 GPFU

The 20 cfm system provides air to armored vehicle crewmen ventilated facemasks, *i.e.*, M42A1/A2. Used on the M1A1/A2 Abrams tanks, Bradley Fighting Vehicles, Multiple Launch Rocket System (MLRS), tank transporter, and other vehicles.

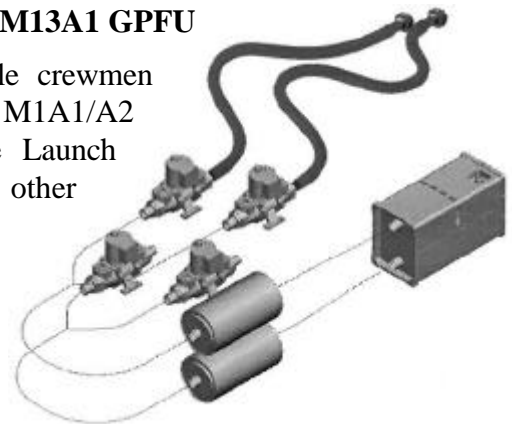

Modular Collective Protection Equipment (100, 200, 400, 600 cfm Systems)

Modular Collective Protection Equipment (MCPE) consists of a family of related end items from which modules can be chosen and combined to meet the unique demands of individual systems. These end items employ common parts and mountings and interchangeable connections and accessories to the greatest extent possible. MCPE provides collective overpressure to a wide variety of mobile shelters and vans. It uses the M48 NBC filter in the 100 cfm system and the M56 NBC filter in the others.

SECTION 2: RDTE ITEMS

INTEGRATED

Force XXI Land Warrior

Rationale:

- Army requirement
- Navy, Air Force, and Marine Corps interest

Key Requirements:

- Protection from all threats for the individual, to include NBC threats
- Integrated vision, communication, and locator systems and enhanced equipment interface

Description:

The Force XXI Land Warrior is an integrated soldier defense system that will improve the warfighter's combat system interface and ability to detect, recognize, and destroy enemy soldiers and equipment. Monitor and protection systems are integrated into a full body ensemble along with advanced locations, communications, microcomputer, and vision systems to maximize the warfighter's battlefield awareness, survivability, and lethality.

RESPIRATORY

Joint Service General Purpose Mask (JSGPM)

Rationale:

- Joint Army, Navy, Air Force, and Marine Corps requirement

Key Requirements:

- 24-hour CB protection
- Lower breathing resistance
- Reduced weight and bulk



Description:

The JSGPM will be a lightweight protective mask system—consisting of mask, carrier, and accessories—incorporating state-of-the-art technology to protect U.S. forces from all future threats. The mask components will be designed to minimize its impact on the wearer’s performance and to maximize its ability to interface with future Service equipment and protective clothing.

Joint Service Aviation Mask (JSAM)

Rationale:

- Joint Army, Navy, Air Force, and Marine Corps requirement

Key Requirements:

- Continuous CB protection
- Improved anti-G features
- Hypoxia protection up to 60,000 feet



Description:

JSAM will be a lightweight CB protective mask that can be worn as CB protection for all aircrew. With the addition of anti-G features, it can be worn as combined CB and anti-G protection for aircrews in high performance aircraft. It will be compatible with existing CB ensembles, provide flame and thermal protection, reduce heat stress imposed by current CB protective masks, and the CB portion will be capable of being donned in flight. JSAM will also be compatible with existing aircrew life support equipment.

BATTLEFIELD PROTECTIVE SUITS

Joint Service Lightweight Integrated Suit Technology (JSLIST)

The JSLIST program is a fully cooperative Joint Service RDTE effort chartered to develop new CB protective clothing for all Services. The program will yield a family of garments and ensembles, developed for Joint Service mission needs and tested to Joint Service standards. The JSLIST will provide enhanced CB protective ensembles with reduced physiological heat burden and will be generally lightweight and launderable. JSLIST is the first of a 3 phase program and supports a variety of Service suit and accessories. Previous chemical protective requirements from all Services are incorporated within the Joint ORD for JSLIST. There are five JSLIST clothing item requirements: 1) overgarment, 2) undergarment, 3) duty uniform, 4) boots and 5) gloves. Each of the Services’ requirements are incorporated by these five JSLIST requirements.

In April 1997, the JSLIST program type classified the JSLIST Overgarment and Multi-purpose Overboot (MULO). The remaining items are being addressed in the JSLIST Pre-Planned Product Improvement (P3I) program, currently underway, with completion scheduled for late 1999. P3I is seeking new and advanced material candidates only. The garment design will be the JSLIST design with only minor design modifications allowed under a P3I.

Lightweight Chemical/Biological Protective Garment (LCBPG) JSLIST P3I

Rationale:

- Army and SOF requirement

Key Requirements:

- Provide 6 hours protection against 10 g/m² liquid; 5000 CT vapor/aerosols
- Provide 7 days field wear (minimum) in all geographical areas (laundryability not required)
- Weigh no more than 4 pounds (3 pounds desired)
- Have package volume for size medium no more than 500 in³ (300 desired)
- Reduce the physiological heat burden by at least 20% (30% desired) over that experienced when wearing the BDO.

Description:

The LCBPG is required to provide 6 hours of protection against all CB agents after moderate periods of wear. The requirement has a trade-off of wear-time and protection-time in order to achieve a lightweight, low-bulk garment for short-term, high-risk missions. The LCBPG will be a two-piece suit designed with an integrated hood compatible with the M40 mask with second skin. It will be worn as an overgarment for the duty uniform or as primary garment over underwear depending upon the environment or mission.

60-Day Overgarment JSLIST P3I

Rationale:

- Joint Army, Navy, Air Force, Marine Corps, and SOF requirement

Key Requirements:

- Provide 24 hours of protection against 10g/m² liquid agent, 5000 CT vapor/aerosols
- Provide 60 days field wear in all geographical areas
- Retain chemical protection after 8 launderings
- Weigh less than 4 lbs for a size medium-regular, packed garment
- Reduce physiological heat burden currently imposed by BDO

Description:

The 60-day Overgarment JSLIST P3I will provide 24 hours protection after extended wear and laundering. Liner candidates are based upon activated carbon technology (carbon beads, thin carbon foam, and others). The 60-Day Overgarment JSLIST P3I will be a two-piece design with an integrated hood compatible with the M40 mask and second skin. The 60-Day Overgarment JSLIST P3I will be worn as an overgarment for the Battle Dress Uniform (BDU), or as a primary garment over personal underwear depending upon the environment and mission.

30-Day Overgarment JSLIST P3I

Rationale:

- Air Force requirement

Key Requirements:

- Provide 24 hours protection against 10 g/m² liquid agent; 5000 CT vapor/aerosols
- Provide 30 days field wear (minimum) in all geographical areas
- Retain chemical protection after 4 launderings
- Weigh less than 4 lbs for a size medium-regular, packed garment
- Reduce physiological heat burden currently imposed by BDO
- Provide less than 20 percent 2nd degree burns at 2-2.5 kcal/cm²/sec for two seconds

Description:

The 30-Day Overgarment JSLIST P3I will provide 24 hour protection after 30 days wear time and 4 launderings. Liners currently are based upon various activated carbon technologies (carbon beads, thin carbon foam and others). It will be a two-piece suit with an integrated hood compatible with the MCU-2/P mask with second skin. The 30-Day Overgarment JSLIST P3I will be worn as an overgarment for the duty uniform or as a primary garment over underwear depending upon the environment and mission.

Vapor Protective Undergarment (VPU) JSLIST P3I

Rationale:

- SOF requirement
- Army, Air Force, and Marine Corps interest

Key Requirements:

- Provide 12 hours protection (24 desired) against 10 g/m² liquid; 10,000 CT vapor/aerosols
- Provide 30 days field wear (minimum) in all geographical areas
- Retain chemical protection after 4 launderings (10 desired)
- Weigh less than 3 pounds
- Reduce the physiological heat burden imposed by the CPU

Description:

The VPU will provide 12 hour protection after extended wear and laundering. It will also offer a reduction for the heat stress burden when compared to the CPU. The VPU will be a one or two-piece undergarment with an integral hood compatible with the M42 series mask.

Duty Uniform (JSLIST P3I)

Rationale:

- Marine Corps requirement
- Army, Air Force, and SOF interest

Key Requirements.

- Enhance existing capability with lighter, less thermal burdening ensemble

Description:

The Duty Uniform will be the primary NBC garment. It will be worn by all Marines, except those aircrew with special environmental or equipment interface requirements and those Marines who must deal with large volumes of liquid contamination. It will provide the wearer with protection from liquid, vapor, and aerosol hazards while reducing physiological stress.

Joint Protective Aircrew Ensemble (JPACE)

Rationale:

- Joint Army, Navy, Air Force, and Marine Corps Requirement (Navy lead)

Key Requirements:

- Provides Below-the-Neck (BTN) protection for rotary and fixed wing aircrew
- 30 day wear time
- Launderable
- Includes hand and foot protection
- Compatible with aircrew mounted aviation life support systems
- Ejection safe and water survivable

Description:

JPACE will be a chemical biological (CB) protective ensemble (including gloves and footwear) for all services' aviation communities. It will be a replacement for the Navy/Marine Corps MK-1 undergarment, Army ABDU-BDO and/or CPU system and AF CWU-66/P overgarment. Due to mission constraints and threat analysis, a separate garment may be considered for fixed wing versus rotary wing aircrew. JPACE started as a spin-off from JSLIST to address aviation specific CB requirements. Therefore, JSLIST and JSLIST P3I materials, designs, and documentation will be used to the maximum extent possible. This ensemble will be jointly tested and fielded with JSAM (Joint Service Aviation Mask) and will be used as a technical insertion to the Army Air Warrior program. JPACE will provide the fixed and rotary wing aviator with BTN protection against CB threats.

Multipurpose Protective Sock (MPS)
(JSLIST P3I)

Rationale:

- SOF requirement
- Army, Air Force, and Marine Corps interest

Key Requirements:

- Provide 12 hours of protection against 10g/m² liquid agent, (5000 mg-min/m³ vapor/aerosols if boot is made of permeable material)
- Provide 30 days field wear
- Must be comfortable, fit well and be compatible with all SOF footwear; *i.e.*, desert, jungle, assault boots, *etc.*
- Retain chemical Protection after 4 launderings

Description:

The MPS will provide 12 hours protection after extended wear and laundering when worn over the issue wool sock and under SOF footwear. The MPS must provide comfort, fit and compatibility when worn over the wool sock and under the various types of SOF footwear. The boots' composition and design will determine whether both liquid and vapor protection must be integrated into the sock material.

**Improved CB Protective Glove
(JSLIST P3I)**

Rationale:

- Joint Army, Air Force, and Marine Corps requirement

Key Requirements:

- Provide 24 hours protection against 10 g/m² liquid agent
- Provide protection against POL and standard decontaminants
- Provide self-extinguishing flame resistance
- Provide 30 days wear durability in all environments without degradation of protection
- Provide dexterity equal to or better than the standard 14 and 25 mil butyl gloves



Description:

Two candidates are being evaluated in the JSLIST P3I glove program. One is a general purpose glove for durability and the other is a high tactile glove for improved dexterity.

COLLECTIVE PROTECTION EQUIPMENT

**Advanced Integrated Collective Protection System (AICPS)
for Vehicles, Vans and Shelters (VVS)**

Rationale:

- Army requirement
- Marine Corps interest

Key Requirements:

- Integral NBC filtration power and environmental control for vehicles, vans and shelters
- Minimize filter changes and overall system logistics burden
- Reduced size, weight and energy requirements



Description:

The AICPS (shown mounted to an S788 Shelter on an M1097 HMMWV) is an NBC filtration system integrated with an environmental control unit and auxiliary power unit

for combat systems. It uses a deep-bed carbon vapor filter for extended gas filter life. The combined components provide overall size, weight and energy reduction, and eliminate the need for additional electrical power from the host system.

Shipboard Collective Protection Equipment

Rationale:

- Navy Service-Unique requirement

Key Requirements:

- Provide protection against chemical and biological threat agents
- Provide a minimum of three year continuous operational life
- Provide more efficient, long life filters
- Provide quieter, more efficient supply fans
- Develop methods to counter new and novel threat agents

Description:

Shipboard Collective Protection Equipment (CPE) provides a contamination-free environment within specified zone boundaries such that mission essential operations and life sustaining functions can be performed during or after a CB attack. The objective of this program is to provide Pre-Planned Product Improvements (P3I) to the current Shipboard CPS to decrease logistic costs by extending particulate filter life, reducing shipboard maintenance requirements, and providing energy-efficient fans. The program develops improvements to existing shipboard HEPA and gas adsorber filters, supports long term shipboard testing of filter improvements to develop filter life database, and provides plans for backfitting existing non-CPS ships. Shipboard CPE is being installed on selected new construction ships.

Collective Protection System (CPS) Backfit

Rationale:

- Navy Service-Unique requirement

Key Requirements:

- Provides protection to forces operating ships within a chemical/biological threat environment
- Provides plans for backfitting existing non-CPS ships

Description:

Collective protection systems use filtered air to pressurize ship zones such that specified contamination-free spaces can remain functional for mission critical and sustaining operations within a chemical/biological threat or contaminated area. CPS backfit provides a means for retrofitting existing ships with required collective protection. Only ships with significant operational life beyond the FY05 through FY10 time frame will be considered for CPS Backfit.

Annex C

Decontamination Programs

SECTION 1: FIELDED AND PRODUCTION ITEMS

PERSONNEL

M258A1 Skin Decontamination Kit (SDK)

The M258A1 consists of a pocket-sized plastic case containing three sets of foil-packaged decontaminating wipes. The decontaminating sets consist of PACKET 1 containing an aqueous decon solution soaked gauze pad, and PACKET 2 containing a decon solution filled glass ampoule within a gauze pad. Personnel use the two wipes successively to remove and neutralize liquid chemical



agents from their skin, clothing, personal equipment and weapons. The shelf life of the M258A1 expired in July 1999 and is replaced by the M291 skin decon kit.

M291 Skin Decontamination Kit



The M291 (shown in use) consists of a wallet-like flexible carrying pouch containing six individually sealed foil packets. Each packet contains a folded non-woven fiber applicator pad with an attached strap handle on one side. The pad contains a reactive and sorptive resin polymer mixture. The kit enables warfighters to remove, neutralize, and destroy chemical and biological warfare agents on contaminated skin. The kit is carried in a pocket of the Battle Dress Overgarment (BDO).

M295 Equipment Decontamination Kit



The M295 (shown in use) consists of a pouch containing four individual wipedown mitts, each enclosed in a soft, protective packet. The pouch assembly is designed to fit

comfortably within the pocket of a BDO. Each wipedown mitt in the kit is comprised of adsorbent resin contained within a non-woven polyester material and a polyethylene film backing. In use, resin from the mitt is allowed to flow freely through the non-woven polyester pad material.

Decontamination is accomplished through sorption of contamination by both the non-woven polyester pad and by the resin. The M295 enables the warfighter to perform basic decontamination to remove, neutralize, or destroy CB warfare agents and toxins on contaminated personal and load bearing equipment.

COMBAT EQUIPMENT, VEHICLES, AND AIRCRAFT

ABC-M11 Portable Decontaminating Apparatus

The 1-1/3 quart capacity M11 is used to spray DS2 decontaminating solution onto critical areas (*i.e.*, frequently used parts) of vehicles and crew served weapons. The M11 consists of a steel cylinder, a spray head assembly, and a small nitrogen cylinder (about 3" long). The refillable M11 can produce a spray 6 to 8 feet long, and cover an area of about 135 square feet. The M11 is currently used on tanks and other systems where the larger M13 Decontaminating Apparatus, Portable (DAP) cannot be effectively stowed.



M13 Decontaminating Apparatus, Portable (DAP)

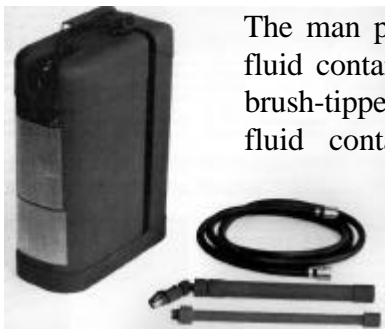

The man portable M13 consists of a vehicle mounting bracket, a pre-filled fluid container containing 14 liters of DS2 decontaminating solution, and a brush-tipped pumping handle connected to the fluid container by a hose. The fluid container and brush head are both disposable. The M13 can decontaminate 1,200 square feet per fluid container. The combination of spray pump and brush allows personnel to decontaminate hard to reach surfaces, and remove thickened agent, mud, grease and other material.

ABC-M12A1 Power Driven Decontamination Apparatus (PDDA); Skid-Mounted

The M12A1 consists of three main components: a pump unit, a 500 gallon tank unit, and a 600 gallon per hour liquid fuel water heater. The M12A1 is a flexible system that can be used for purposes such as de-icing, fire fighting with water or foam, water pumping and transport, and personnel showering in addition to equipment and area decontamination. The M12A1 can pump 50 gallons of decontaminating solution per minute through both of its hoses. The integral shower assembly provides 25 shower heads. The M12A1 is typically mounted on a 5 ton truck for tactical mobility, but can be dismantled to facilitate air transport. The USMC has replaced the M12A1 PDDA with the M17 series Lightweight Decontamination Apparatus.



M17 Series Lightweight Decontamination Apparatus

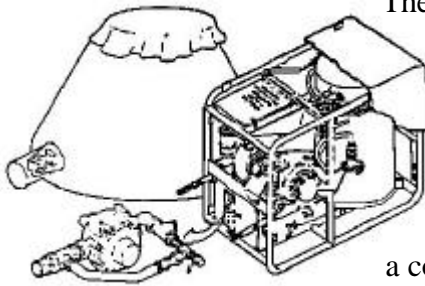

The M17 series Lightweight Decontamination System is a portable, lightweight, compact engine driven pump and water heating system. The system is used during decontamination operations. The LDS is capable of drawing water from any source and delivering it at moderate pressure and controlled temperatures. The system has an accessory kit with hoses, spray wands, and personnel shower hardware. It also includes a collapsible water bladder.

M21/M22 Modular Decontamination System (MDS)

The MDS provides the warfighter an improved capability to perform detailed equipment decontamination on the battlefield. The system replaces current methods of decontamination application (*i.e.*, mops and brooms or with the portable

M13 Decontamination Apparatus), which are time consuming and labor intensive. The MDS improves effectiveness, reduces water usage, reduces equipment processing time, and is less labor intensive.

The MDS consists of an M21 decontaminant Pumper/Scrubber module, and M22 High Pressure/Hot Water



module. The M22 delivers DS2 or liquid field expedient decontaminants and is capable of drawing the decontaminant directly from a container on the ground while mounted on a trailer. The M22 provides hot water up to 3000 psi at a rate of 5 gpm with the capability of high volume cold water and detergent injector. It is also capable of drawing water from natural and

urban water sources (such as fire hydrants) and delivering it at variable and adjustable pressures, temperatures and flow rates. Each module (M21 or M22) may be transported or operated from a 3/4-ton trailer towed by a M1037 High Mobility Multipurpose Wheeled Vehicle (HMMWV).

SECTION 2: RDTE ITEMS

COMBAT EQUIPMENT, VEHICLES, AND AIRCRAFT

Joint Service Sensitive Equipment Decontamination (JSSED)

Rationale:

- Joint Service requirement

Key Requirements:

- Non-aqueous based decontamination systems for sensitive equipment and vehicle interiors
- Capable of being used in both mobile and fixed-sites

Description:

Provide a first ever capability to decontaminate chemical and biological warfare agents and toxins from sensitive electronic, avionics, electro-optic equipment, and vehicle interiors. Its use must be compatible with and not degrade sensitive materials or equipment. It must be operator safe and offer protection from off-gassing and direct liquid exposure during decontamination.

Sorbent Decontamination System

Rationale:

- Army and Marine Corps requirement

Key Requirements:

- Effectively decontaminates all CB warfare agents from contaminated surfaces
- Easy-to use and possess no hazard to users
- Non-damaging and non-corrosive to military equipment
- Environmentally safe to store
- More compatible with MOPP and military equipment than the currently used DS2

Description:

The reactive sorbent decontamination system provides a simple, rapid, and efficient system to decontaminate small and individual issue items of equipment. It is effective in all environments, is less corrosive, and presents a lowered logistics burden through improved shelf life and reduced special handling and storage needs. The system uses a catalytic component that reacts with the chemical agents being sorbed; this eliminates the potential hazard created by the off-



gassing of agents from used sorbents.

M17 Diesel Lightweight Decontamination System (LDS)

Rationale:

- Navy and Marine Corps requirement

Key Requirements:

- Be capable of operation using Military Standard (MIL STD) fuels
- Have no component which cannot be moved by a four man crew
- Be capable of decontaminating both sides of a vehicle or aircraft simultaneously
- Generate no new manpower requirements
- Decontaminate personnel, equipment, and other material without an external power source and in coordination with a water tank or natural water resource.

Description:

The Diesel LDS is a portable, lightweight, compact, engine-driven pump and multifuel-fired water heating system. The system will be capable of performing the same hasty and deliberate decontamination procedures as required of the M17 series LDS.

Joint Service Fixed Site Decontamination System

Rationale:

- Army, Air Force, and Marine Corps requirement

Key Requirements:

- Provide restoration capability at fixed site locations
- Provide improved/state-of-the-art NBC decontamination equipment
- Provide non-hazardous and environmentally safe NBC decontaminates

Description:

The Joint Service Fixed Site Decontamination program is a joint effort. The system will provide a family of decontaminants and applicators to provide the capability to decontaminate ports, airfield, and rear-area supply depots.

(INTENTIONALLY BLANK.)

Annex D

Joint Medical Chemical, Biological, and Nuclear Defense Research Programs

The joint medical chemical, biological, and nuclear (radiological) defense research programs are each addressed in the next three sections.

D.1 MEDICAL CHEMICAL DEFENSE RESEARCH PROGRAM

D.1.1 Fielded Products

Advances in medical research and development (R&D) significantly improve the war-fighting mission by sustaining unit effectiveness through conserving the fighting strength of our forces and supporting the nation's global military strategy, which requires the ability to effectively deploy and operate. Medical R&D products (materiel and non-materiel solutions) provide the foundation that ensures the fielding of a flexible, sustainable, modernized force across the spectrum of conflict and in the full breadth and depth of the battlefield. Overcoming medical threats and extending human performance have provided a significant increase in military effectiveness in the past and present the potential for future enhancement of military operational effectiveness. Following are fielded medical chemical defense items, including pharmaceuticals, materiel, and technical information and guidance (with initial fielding date shown.)

Pharmaceuticals:

- Nerve Agent Antidote Kit (Mark I), 1983
- Skin Decontamination Kit (M291), 1990
- Nerve Agent Pretreatment (Pyridostigmine), 1987
- Convulsant Antidote for Nerve Agent (CANA), 1991
- Medical Aerosolized Nerve Agent Antidote (MANAA), 1994



**MARK I, M291, Nerve Agent
Pretreatment, and CANA**

Materiel:

- Test Mate® ChE (Cholinesterase) Kit, 1997 (*shown*)
- Resuscitation Device, Individual, Chemical, 1990
- Decontaminable Patient Litter (NSN 6530-01-380-7309), 1991
- Chemical Warfare (CW) Protective Patient Wrap (NSN 8415-01-311-7711), 1991
- Computer-Based Performance Assessment Battery, 1993
- M40 Protective Mask Vision Correction (optical inserts)



***Decontaminable Patient Litter and
CW Protective Patient Wrap***

Technical Information and Guidance:

- Taxonomic Work Station, 1985
- U.S. Army Medical Research Institute of Chemical Defense (USAMRICD) Technical Memoranda on Chemical Casualty Care, 1990
- Field Manual (FM) 8-285, *Treatment of Chemical Agent Casualties and Conventional Military Chemical Injuries*, 1995
- Handbook, "Medical Management of Chemical Casualties," 1995
- Field Management Handbook, "Medical Management of Chemical Casualties," 1996
- Technical Bulletin (TB) Medical (MED) 296, 1996: *Assay Techniques for Detection of Exposure to Sulfur Mustard, Cholinesterase Inhibitors, Sarin, Soman, GF, and Cyanide*.
- Compact Disk - Read-Only Memory (CD-ROM) on "Management of Chemical Warfare"
- *Medical Management of Chemical Casualties Handbook*, Third Edition, August 1999.

D.1.2 Medical Chemical Defense R&D Accomplishments

The medical chemical defense R&D technical barriers and accomplishments during FY98 are grouped by medical chemical defense strategies, which include the following:

- *Pretreatment*
- *Therapeutics*
- *Diagnostics*

Today's chemical threat, however, is not restricted to commonly accepted classical agents, such as vesicants [sulfur mustard (HD)], nerve agents (soman, sarin, tabun, and VX), respiratory agents (phosgene), or blood agents (cyanide). Potential adversaries may develop novel threat agents. The ability to provide timely and effective medical countermeasures to new threats depends upon maintaining a high level of technological capability. Sustaining and enhancing this technological capability is dependent upon the continued support of a robust

program investigating basic pathophysiological mechanisms which, in turn, contributes to the knowledge and database upon which new, innovative, and improved diagnostics, pretreatments, and therapies are based.

Countermeasure strategies to the classic and novel threats include pharmaceuticals, medical equipment, specialized materiel or medical procedures, and concepts for training, doctrine, and organization. Medical countermeasures are designed not only to prevent lethality but also to preserve and sustain combat effectiveness in the face of combined threats from chemical and conventional munitions on the integrated battlefield by:

- Rapid diagnosis of chemical agent exposure.
- Prevention of the effects of chemical agents (*e.g.*, prophylaxes or pretreatment).
- Far-forward treatment upon exposure to chemical warfare threats (*e.g.*, antidotes).
- Chemical casualty care (*e.g.*, therapy and management).

Research Category: Pretreatments

The countermeasures, technical barriers, and accomplishments in the medical chemical defense research category of pretreatments are outlined below.

Countermeasures:

- Reactive topical skin protectant (rTSP) for chemical agents.
- Pretreatment regimen that protects against rapid action and incapacitating effect of chemical threat category of nerve agents and novel threat agents.
- Pharmaceutical and biological pretreatments, treatments, antidotes or decontaminants and protectants.

Technical Barriers:

- Lack of pretreatments or antidotes that are quick acting, long lasting, easy to carry and use on the battlefield.
- Lack of appropriate experimental model systems to predict pretreatment or treatment efficacy and safety in humans.
- Lack of detailed molecular model of novel threat agents to understand the origin of their unique chemical properties.
- Potential performance decrement with pretreatment is being investigated.

Accomplishments:

Accomplishments are shown for the concept exploration, applied research, and basic research related to the development of pretreatments.

- Demonstrated that reactivation of organophosphate-inhibited acetylcholinesterase by oximes is accelerated in the presence of serum paraoxonase, suggesting that cholinesterases, oximes and organophosphorus hydrolases can work in tandem to hydrolyze or inactivate all organophosphates *in vivo* and *in vitro*.

- Demonstrated human serum butyrylcholinesterase (BuChE) was to be a single effective pretreatment drug against all organophosphate nerve agents in non-human primates without causing any performance decrement.
- Developed a joint program with WRAIR, USAMRICD, and the American Red Cross to prepare ~1,000 doses of human BuChE under GMP conditions.
- Initiated the evaluation of the immunologic response of repeated injections of homologous butyrylcholinesterase in monkeys, which will provide initial data leading to a pretreatment agent for humans, not only for soldiers but for any other first responders (civilians) to terrorist nerve gas release/attack or pesticide overexposure.
- Synthesized and evaluated 43 analogs of huperzine A (in collaboration with Georgetown University) and 11 analogs of tacrine (in collaboration with Università Degli Studi Di Siena) as candidate pretreatment drugs for protection against organophosphate toxicity.
- Compared the efficacy of huperzine A and its analogs, tacrine and its analogs, and E2020 (Aricept) as pretreatment drugs for protection against organophosphate toxicity.
- Developed a fluorescent polarization assay to determine the interactions between proteins and peptides, and found that fluorescent A β peptide 1-40 binds to cholinesterases. The interaction between A β peptides and cholinesterases may influence neurodegeneration in Alzheimer's disease.
- Characterized five mutants of BuChE designed to hydrolyze nerve agents.
- Demonstrated that OPA hydrolase (PON 1) has the ability to catalyze the hydrolysis of VX as well as the G agents. Kinetic constants for that reaction are now being determined.
- Prepared crystals of unaged VX-inhibited AChE that refract to high resolution. For the first time we are able to see the precise orientation of this inhibitor in the active site of cholinesterase and thereby more accurately describe the requirements for nerve agent hydrolysis by genetically engineered mutants.
- Neutralized the glutamic acid group at position 337 in human carboxylesterase (CaE) which abolished activity for the substrate p-nitrophenylbutyrate. This result allowed the verification of the CaE molecular model with respect to the residues involved in the catalytic triad.
- Developed a theoretical model for the role of hydrolysis and CaE in protection against nerve agent poisoning.
- Discovered that sarin-inhibited CaE undergoes spontaneous reactivation.
- Compared OP specificity of CaE, BuChE and AChE and correlated differences to occurrence of specific amino acid residues.
- Determined that an antibody raised against a soman analogue linked to the carrier human serum albumin bound to the four individual stereoisomers of soman [C(+) P (+), C(+) P (-), C(-) P (+), and C(-) P (-)] but did not bind to the hydrolysis product of soman or to a set of structurally similar organophosphinates.
- Began sequencing the heavy and light chain genes used to encode each of three anti-soman antibodies, in order compare the respective genetic and deduced amino acid structures.
- Provided purified antibody to the Army Research Laboratory to attach to a solid support as a first step in making an immunodiagnostic 'ticket'.
- Determined that antibodies expressed in response to immunogens containing a rigid

pentavalent phosphorus transition state analogue (TSA) bound GD, the GD stereoisomers, GB, and structurally related analogues equally well but did not bind to a related set of phosphinates.

- Determined that antibodies against a ‘bait and switch’ TSA (G5D.2, A8E, IG5/F5/H6) bound all of the inhibitors equally well, but with IC50 values of ~1 μM , which suggested that antibodies against the rigid pentavalent and ‘bait and switch’ TSAs display different binding properties.
- Sequenced heavy and light chain genes of seven of the antibodies raised against the TSAs.

Research Category: Therapeutics/Diagnostics

The countermeasures, technical barriers, and accomplishments in the medical chemical defense research category of therapeutics/diagnostics are outlined below.

Countermeasures:

- Products that prevent or moderate vesicant injury.
- Medical countermeasures to minimize lethality, morbidity, and incapacitation of these agents.
- Specific casualty management techniques to improve survival and minimize lost duty time.
- Pharmaceutical/biological pretreatments, treatments, antidotes, or decontaminants/protectants.

Technical Barriers:

- Need for quick-acting and long-lasting antidotes that are deployable.
- Lack of appropriate experimental model systems for treatment efficacy and safety in humans.
- Need for detailed molecular model of novel threat agents to understand the origin of their unique chemical properties.
- Lack of simple and sensitive field-portable diagnostic assays for CWA exposure.

Accomplishments:

- Demonstrated that by using matrix-assisted laser desorption ionization/time of flight (MALDI/TOF) mass spectrometer and whole spectrum protein profiling technique, distinct and consistent mass spectra can be obtained from blood, skin, or lung lavage samples to diagnose sulfur mustard exposure.
- Found that approximately 20% of circulating sulfur mustard binds with plasma proteins to form alkylated adducts. A sensitive GC/MS method was developed to hydrolyze the sulfur mustard adducts at the carboxyl terminal of proteins. The freed thiodiglycol was derivatized and monitored by mass spectroscopy. A lower detection limit of one nanomole of sulfur mustard was achieved.
- Found that human skin tissue exposed to HD becomes blistered and releases multiple inflammatory mediators. A multicomponent lotion containing a leukotriene antagonist was formulated and demonstrated to be effective in preventing HD blister formation.

- Observed with spin-labeled insulin and EPR techniques the alteration of insulin receptors on red blood cell membrane following HD exposure. The effect on insulin receptors was HD dose-dependent. The changes were detectable at 25 uM concentration four hours after exposure.
- Developed an *in vitro* model to screen topical ophthalmic protectants and treatments for HD injury using the bovine isolated cornea. Corneal injury was evaluated by corneal opacity, thickness, fluorescein dye penetration, and histopathology.
- Demonstrated efficacy of an ophthalmic solution containing taurine, sodium pyruvate, alphaketoglutarate, and pantothenate for counteracting the corneal damages caused by half sulfur mustard (2-chloroethyl ethyl sulfide, CEES).
- Demonstrated that corticosteroid and antibiotic treatment provide beneficial effects towards HD ocular injury, but the changes were transient following cessation of therapy suggesting that ophthalmic treatments may need to be administered for longer periods to obtain benefits.
- Observed that because HD casualties suffer burns of varying degrees of depth and severity, different treatment regimens are required. Therapies under investigation include laser debridement, temporary wound dressings, surgical excision, and autologous skin grafting. Pulse laser debridement of sulfur mustard wounds significantly shortened the wound healing process.
- Identified multiple bioengineering methods and measurements for evaluating HD injury. These include laser doppler perfusion imaging (to monitor capillary flow), trans-epidermal water loss (to assess skin barrier function), reflectance colorimetry (to measure erythema and pigmentation), ultrasound (to show degree of edema), conductance (to measure epidermal hydration), ballistometry (to indicate skin elasticities), and digital photography (wound contraction).
- Demonstrated in a human epidermis model that exposure to CEES induced programmed cell death (apoptosis) as evidenced by cytoplasmic blebbing and chromatin clumping, clearly observable in electron micrographs.
- Demonstrated that the potential vesicant antagonists niacinamide, zaldaride maleate, or leupeptin, used singly, did not provide significant protection from CEES exposure suggesting that simultaneous blockade of multiple pathways of potential cellular damage may be required to achieve notable beneficial effects.
- Established that the pro-inflammatory cellular mediators interleukin (IL)-1, IL-6, IL-8, tumor necrosis factor- β , and prostaglandin E₂ are not significantly affected by epidermal damage, suggesting that keratinocytes are not responsible for the inflammatory response induced by CEES.
- Demonstrated that heat shock protein-70A was not increased by exposure to CEES, thus suggesting the possibility that prior elevation of this cytoprotective protein could provide prophylaxis to the pathophysiological effects of CEES.
- Demonstrated that elevation of IL-1 receptor antagonist may be a useful biochemical metric of CEES-induced injury.
- Demonstrated that exposure of a human epidermis model to CEES resulted in the prominent release of IL-1 receptor antagonist which indicates that the acute response to half-mustard is characterized by a concomitant anti-inflammatory component.

- Developed a swine model to study and evaluate the efficacy of candidate therapeutic compounds and clinical interventions. Anesthesia in the weanling pig model by intramuscular Telazol[®]/Rompun[®] produced the most consistent results over time and was the drug of choice for future wound healing studies.
- Prepared polyurethane sponges containing mixtures of immobilized acetyl and butyrylcholinesterases and OP hydrolases for skin or drinking water decontamination. Cholinesterase sponges detoxified surrogate OPs at a greater than 500-fold excess in the presence of the oxime reactivator HI-6. The enzyme-immobilized sponges retained high activity at room temperature after more than 8 months.
- Prepared immobilized multi-enzyme sponges composed of cholinesterases and organophosphate hydrolases to replace single enzyme sponges for improved decontamination and detoxification of nerve agents.
- Demonstrated immobilized enzymes' remarkable retention of catalytic activity to environmental extremes (heat, cold, wet, dry, multiple use), and developed additives to sponges to improve removal of organophosphates from permeable surfaces.
- Developed a more versatile and accurate dipstick biosensor for organophosphates composed of immobilized cholinesterases to replace the current fielded detector.
- With commercial partners, prepared activated cotton fabrics to which organophosphate hydrolyzing enzymes were immobilized.
- Evaluated a therapeutic approach to treat phosgene-induced acute lung injury in a murine model. Mice fed butylated hydroxyanisole and n-propyl gallate had significantly increased survival rates. Post-treatment with buffers such as sodium carbonate, saline, N-acetylcysteine, L-2-oxothiazolidine-4-carboxylic acid enhanced survival of mice exposed to phosgene.
- Mice, following phosgene exposure, showed signs of respiratory acidosis with significant increases in serum potassium, total carbon dioxide, hematocrit and hemoglobin, with maximum changes observed at 8 hours and return to normal parameters at 24 hours.
- Determined that treatment with benzamide (poly ADP ribose polymerase inhibitor) did not reduce the mortality rates in mice after phosgene exposure. Treatment with 2-mercaptoethane sulfonic acid (MESNA) increased survival rate with increased -SH levels and decreased protein oxidation.
- Showed that in swine exposed to phosgene, ibuprofen infusion at half hour and then every one and a half hours for 24 hours prolonged survival time. The rate of pulmonary edema formation over the survival time decreased by 46%. Positive and expiratory pressure (PEEP) and 45% oxygen treatment were not effective.
- Showed in human plasma that the biotransformation of VX depended on two pathways; enzymatic and spontaneous hydrolyses. The spontaneous hydrolysis is a much slower process. Initially, the enzymatic hydrolysis was the predominant pathway but it underwent a product-limited kinetic mechanism and plateaued at later stage. This could explain the persistent toxic action of VX *in vivo*
- Demonstrated by LC/MS that in human serum the OP hydrolase selectively degraded the nontoxic VX P(+) stereoisomer at a faster rate than the toxic P(-) isomer.
- Initiated a collaborative effort with industry (Datex-Ohmeda, Inc.) to develop a prototype non-invasive methemoglobin monitor. A final hand-held, real-time monitor for

methemoglobin, oxyhemoglobin, carboxyhemoglobin, oxygen, and possibly cyanide is anticipated in the next two to three years.

Research Category: Reducing Reliance on Animals and Human Volunteers

- An *in vitro* model is being developed to evaluate the chronic effect of low dose exposure to nerve agents and other toxic compounds.
- An *ex vivo* neuronal model has been developed for rapid screening of neuroprotectants against seizures induced by organophosphate chemical warfare nerve agents, toxicity induced by excitatory amino acids, and EEG perturbations and seizures induced by NMDA.

D.1.3 Advanced Development Products

In advanced development, the goal is proof-of-principle and conducting all studies necessary to obtain FDA approval/licensure of drugs, vaccines, and devices. The medical R&D process links the materiel developer (U.S. Army Medical Research and Materiel Command, USAMRMC) with the combat and training developer (U.S. Army Medical Department Center and School, AMEDD C&S) and the logistician (U.S. Army Medical Materiel Agency, USAMMA) in addressing the threat and JMCBDRP requirements. Medical chemical defense products now in the advanced development phase are the following:

Product: Topical Skin Protectant (TSP)

Concept:

- Use perfluorinated formulations.
- Form nontoxic, nonirritating barrier film layer on skin.
- Augments Mission Oriented Protective Posture (MOPP).
- Protection against vesicant and nerve agents.

Accomplishments:

- Completed manufacturing development of the TSP.
- Completed sweating and absorption studies requested by the FDA.
- Prepared and submitted a New Drug Application to the FDA.



Product: Multichambered Autoinjector

Concept:

- Speed administration of life-saving antidotes against nerve agents.
- Replace two-Injector Mark I Nerve Agent Antidote Kit with single autoinjector.

Accomplishments:

- Production line upgrade underway.
- Received approval from the Training and Doctrine Command for the Operational Requirements Document for the multichambered autoinjector.

- Multichambered autoinjector transitioned to the Engineering and Manufacturing Development Phase (Phase 2) of the DoD 5000 Acquisition Process.
- Prepared a New Drug Application for submission to the FDA.

Product: Cyanide Pretreatment

Concept:

- Provide protection against incapacitation and lethality without performance degradation.
- Enhance soldier protection and sustainment.

Accomplishments:

- Prepared an Investigational New Drug Application.
- Developed an oral formulation for clinical studies.
- Identified unanticipated toxicity in non-human primates, suspended advanced development, and returned this effort to tech base for more studies.

D.2 MEDICAL BIOLOGICAL DEFENSE RESEARCH PROGRAM

D.2.1 Biological Defense Products

Advances in DoD medical R&D significantly impact the warfighting mission by sustaining unit effectiveness through conserving the fighting strength of our forces and supporting the nation's global military strategy, which requires the ability to effectively deploy and operate. Medical R&D products (materiel and non-materiel solutions) provide the foundation that ensures the fielding of a flexible, sustainable, modernized force across the spectrum of conflict and in the full breadth and depth of the battlefield. Overcoming medical threats and extending human performance have provided a significant increase in military effectiveness in the past and present the potential for future enhancement of military operational effectiveness. Some of the materiel and non-materiel solutions are fully licensed and available for use while others are in investigational new drug (IND) status, which may only be used consistent with Executive Order 13139. In 1997, a Prime Systems Contract under the Joint Vaccine Acquisition Program (JVAP), was activated to move mature solutions from the technology base through advanced development to FDA licensure and procurement of baseline stockpiles. Currently licensed and IND solutions for use in medical biological defense R&D include the following:

Vaccines and Antisera:

- Anthrax Vaccine (licensed)
- Smallpox Vaccine (licensed)
- Botulinum Toxoid Vaccine, Pentavalent (IND #3723)
- Botulinum Type F Toxoid Vaccine (IND #5077)
- Botulinum Antitoxin, Heptavalent Equine (Types A, B, C, D, E, F, and G) (IND #3703)
- Botulism Immune Globulin, Human (IND #1332)
- Botulism, Antitoxin, Heptavalent Equine, Types A, B, C, D, E, F, and G (IND #5077)
- Q Fever Vaccine, Purified Whole Cell, CM Residue, Formalin Inactivated, Gamma Irradiated (IND #3516)
- Tularemia Vaccine (IND #157)
- New smallpox vaccine (Vaccinia Virus, Cell Culture-derived) (IND #4984)
- Venezuelan Equine Encephalitis Virus Vaccine, TC-83 (IND #142)
- Eastern Equine Encephalitis Virus Vaccine (IND #266)
- Western Equine Encephalitis Virus Vaccine (IND #2013)



The status of medical materiel solutions being managed by the Joint Program Office for Biological Defense (JPO-BD) and JVAP are reported in Section D.2.3.

Technical Information and Guidance:

- Handbook “Medical Management of Biological Casualties,” 1998.
- CD-ROM on “Management of Biological Warfare Casualties,” 1999.
- NATO Handbook “Medical Aspects of NBC Defensive Operations, AMedP-6(B), Part II (Biological),” 1998.

D.2.2 Biological Defense Research and Development Accomplishments

The biological defense research and development technical barriers and accomplishments during FY99 are grouped by the following medical defense strategies against biological threats (bacteria, viruses, and toxins)g:

- Vaccines against bacterial agents
- Therapeutics for bacterial agents
- Vaccines against viral agents
- Therapeutics for viral agents
- Vaccines against toxin agents
- Therapeutics for toxin agents
- Diagnostics

Several projects and technologies are shared with other agencies, including the Department of Energy (DOE) and the Defense Advanced Research Projects Agency (DARPA). The DOE projects tie into the strengths of the DOE laboratories in developing advanced technologies in order to enable rapid detection of and response to a chemical or biological agent incident. DOE is not involved directly in protection and treatment of personnel, but actively assists DoD with drug/chemical database searches, DNA sequencing, advanced protein chemistry and modeling/simulation projects. Successful sequencing of plasmids found in the causative agents of plague and anthrax helped create the “lab on a chip”. The extensive knowledge and databases available to DOE allow application of computational tools to predict sites of intervention by novel therapies against threat agents.

DARPA is pursuing multi-agent and broad-spectrum approaches, both to defend against current known threats and to anticipate potential future threats. Accomplishments of DARPA programs for FY99 include the following:

Medical Countermeasures Research and Development by DARPA:

- Demonstrated that manipulated mesenchymal stem cells (MSCs) can be transduced with the C fragment of the tetanus toxin to induce the production of antibodies.
- Identified over 300 novel DNA-binding monomers and 4 novel double stranded RNA-binding monomers to target the replicative intermediates of RNA viruses.
- Expressed active enzymes (phospholipase C, nuclease A) *in vivo* to produce a proprietary vaccine delivery system with potential for rapidly deployable applications for both military and civilian populations.
- Developed a peptide (P-12) with broad spectrum activity that has demonstrated

protection *in vivo* from a lethal dose of SEB as well as eliciting a more rapid immunization than normally occurs in the body.

- Developed a chimeric molecule (antigen presenting cell and T cell receptor subunits) to act as a Major Histocompatibility Complex (MHC) decoy protein, binding with SEB molecules and preventing pathogenesis.
- Developed an antiviral vaccine (patent pending) that exhibits potential for broad spectrum preventive and therapeutic activity with no toxicity or interference with normal cell proliferation.
- Demonstrated, through rabbit studies, that immunization may be possible through the consumption of an edible vaccine based on assembled epithelial transport molecules (TMs).
- Demonstrated 99.9% protection against the simulants of biological pathogens (BG) and chemical agents (DMMP) by utilizing a prototype helmet and filter system (Advanced Toxic Environment Combat Helmet and the Chem/Bio Photo/Electrocatalytic Filter Reactor).
- Confirmed that changes in gene expression, which were observed after *in vitro* exposure of human peripheral blood lymphocytes to SEB, were similar to changes observed in monkeys challenged with SEB. Gene changes in monkeys challenged with SEB appeared prior to onset of symptoms (30 minutes) and persisted up to at least 12 hours post-exposure.
- Showed 19 genes are altered after human lymphocytes are exposed to anthrax *in vitro*; many of these genes displayed unique altered expression.
- Isolated peripheral blood lymphoid cells and prepared RNA from anthrax-challenged monkeys for analysis of *in vivo* gene changes.
- Identified, in lymphoid cells exposed to plague and cholera toxin (*in vitro*), that some changes in gene expression were common to several toxins while others were unique to each specific toxin.
- Found that some genes that were altered by several toxic agents examined are not unique to a specific toxin but may still be indicative of certain common symptoms such as loss of regulation of vascular tone.

Advanced Medical Diagnostics:

- Demonstrated feasibility of using exhaled nitric oxide (NO) as an early marker of infection of BW exposure.
- Began development and testing of standardized procedures for a variety of sample types using the integrated DNA sample preparation cartridge developed last year. Developed a spore disruption attachment for preparing samples containing anthrax spores.
- Preliminary studies demonstrating feasibility of using engineered red blood cells to detect pathogen exposure in the body.
- Began studies evaluating use of “gene chips” (multigene arrays) to identify candidate host markers of infection/exposure.

Consequence Management Tools:

- ENCOMPASS (Enhanced Consequence Management Planning and Support System), an integrated set of consequence management tools, was developed and demonstrated with the Marine Corps Chemical and Biological Incident Response Force.

Medical biological defense research conducted or sponsored by the United States Army Medical Research and Materiel Command (USAMRMC) laboratories yielded the following accomplishments in FY99:

Medical Countermeasures Research and Development by the United States Army Medical Research Institute of Infectious Diseases (USAMRIID):

Bacterial Agents

The countermeasures, technical barriers, and accomplishments in the biological threat category of bacterial agents are outlined below.

Countermeasures:

- Vaccines for immunity against bacterial threat agents.
- Therapeutics for treatment of bacterial diseases.

Technical Barriers:

- Incomplete genetic information for all of the bacterial threat agents.
- Lack of appropriate animal model systems for investigation of some bacterial threats and countermeasures.
- Lack of suitable epidemiological situations in which to perform human clinical trials to evaluate efficacy of vaccines.
- Difficulty in field testing rapid identification kits under natural conditions.
- Difficulty in defining surrogate markers of protection.
- Necessity to enhance the otherwise limited data on which to base rational drug and antibody therapies for bacterial agents of interest.
- Necessity to establish and maintain capabilities to assess threats and provide countermeasures for new, emerging, and genetically engineered bacterial threats.

Accomplishments:

Vaccines:

- Completed annotation of the *Yersinia pestis* murine toxin plasmid DNA sequence.
- Completed annotation of the DNA sequence obtained from a small cryptic plasmid that is emerging in strains of *Y. pestis* isolated in the Peoples Republic of China.
- Determined the DNA sequence of 1,000 random *Francisella tularensis* clones as part of the genome sequencing project.
- Determined the DNA sequence of the *Y. enterocolitica* large virulence plasmid for comparison with the similar plasmid harbored by *Y. pestis*.
- Developed a simple, scaleable two-step purification method for the F1-V plague vaccine

candidate, and initiated short and long-term stability studies on both unformulated and formulated F1-V preparations.

- Completed preliminary F1-V efficacy experiment in both rodents and non-human primates, the results of which showed a high degree of protection against lethal aerosol and parenteral exposure to plague.
- Characterized the F1-V protein by additional biochemical/physical methods, to include mass spectrometry and x-ray crystallography.
- Completed preliminary potency experiments in mice, comparing several different F1-V preparations.
- Initiated development of a surrogate marker ELISA assay using a monoclonal antibody to the F1 protein and initiated evaluation of immune serum derived from dose-response studies in mice.
- Protected mice against lethal parenteral challenge with plague by passive transfer of F1-V immune serum from rabbits.
- Initiated studies of the utility of other plague antigens, especially YopD, as well as V antigens from different strains of *Yersinia*, as potentially useful immunogens.
- Initiated construction of allelic replacement vectors carrying various V antigen types, to support testing of vaccine candidates against potential *Y. pestis* strains encoding a non-consensus sequence V antigen.
- Continued collaboration with Los Alamos National Laboratories and Northern Arizona University on analysis of the genetic diversity of *Y. pestis* based on variable number tandem repeat (VNTR) alleles.
- Characterized the newly-developed *in vitro* bioassay for V, which is based on the lethal apoptotic effects of V on macrophages.
- Determined that a potentially protective live, attenuated (Pgm-) strain of *Y. pestis* which appeared promising in rodents had significant virulence for monkeys by the aerosol route.
- Initiated efforts to engineer additional attenuating mutations into Pgm- strains of *Y. pestis*, which might prove useful as live, attenuated vaccine candidates.
- Identified two new model systems in which to screen for attenuating mutations in *B. pseudomallei*, and determined that virulence in these models is not due to bacterial lipopolysaccharide, capsule, Type II secreted factors, or the flagellar apparatus.
- Developed the first transposon mutagenesis procedure for *B. mallei*, which will allow a greater understanding of the molecular biology of *B. mallei* and may lead to discovery of suitable vaccine candidates.
- Identified the putative capsule genes for *B. mallei*, which may be the first clearly defined virulence factors for this organism, as mutants that do not make capsule are avirulent in the hamster model of glanders.
- Developed PCR primers for putative type III secretion genes of *B. pseudomallei* and *B. mallei*, and used these primers to explore mutants for their relative virulence in animal models of infection.
- Protected mice from lethal *B. mallei* challenge by immunization with a vaccine containing irradiation-killed *B. mallei* whole cells and irradiation-killed *C. burnetii*, even though spleens contained significant *B. mallei* organisms.
- Initiated histopathological studies of mice challenged by aerosol with sublethal and lethal

doses of *B. mallei*, in support of comprehensive understanding of the pathogenesis of this disease and development of a suitable animal model for vaccine and therapeutic studies.

- Examined antigenic relationships, using immunoblot and ELISA, among the numerous strains of *B. mallei* and related organisms collected to date.
- Prepared various organic extracts of *B. mallei* to evaluate for sensitivity and specificity in an ELISA and for exploration as potential vaccine candidates.
- Conducted a comparative serological study of five different species of laboratory animals immunized with the licensed anthrax vaccine, using both ELISA and toxin neutralization assays, in support of studies to understand and differentiate among the different animal models.
- Characterized the isoelectric point of the three protein components of the two anthrax toxins (PA-EF and PA-LF) in order to better understand various genetic classifications of different isolates and their virulence patterns.
- Initiated studies on the ability of CpG oligonucleotides to protect animals from *B. anthracis* challenge, and found a small level of non-specific protection in mice.
- Completed aerosol challenge study in rabbits and rhesus monkeys of *B. anthracis* strains which were highly virulent in AVA-immunized guinea pigs, and found that the licensed vaccine provided excellent protection in both the monkey and the rabbit model.
- Completed studies in immunized rabbits comparing the virulence of *B. anthracis* spores with that of vegetative cells, and found that rabbits were completely protected against challenge with either form of the organism.
- Inserted the C-terminus of the heavy chain of the botulinum neurotoxin gene into the genome of *B. anthracis* by transposon-mediated mutagenesis in order to explore a live, attenuated, multivalent vaccine vector system.
- Characterized the DNA sequence for two genes involved in replication of *B. anthracis*, and which are essential for further development of cloning systems for expressing homologous and heterologous antigens in *B. anthracis*.
- Screened representative samples of Ames and V1B *B. anthracis* variants for *vrrA* type, which appears to be stable in these strains, and may potentially be useful as a marker to indicate the presence of discrete strains.
- Continued studies on the anti-spore activities of antitoxin antibodies to determine their role in protection early in infection; the antibodies stimulated phagocytosis of spores by macrophages and inhibited spore germination *in vitro*.
- Produced several neutralizing monoclonal antibodies against V antigen of *Y. pestis* to aid in identifying neutralizing epitopes in the V antigen and the development of a competitive ELISA.
- Collaborated with investigators at WRAIR developing *Brucella* sp. based vaccine delivery vector.

Therapeutics:

- Established, in accordance with internationally accepted clinical standards, a microdilution “minimum inhibitory concentration” (MIC) method for determining valid antibiotic susceptibility profiles for biological threat agents.
- Established MIC ranges for key strains of *B. anthracis*, *Y. pestis* and *B. mallei*; 28

antibiotics were tested on 11 strains of *B. mallei* and 4 strains of *B. mallei*; 29 antibiotics were screened against one specific strain of *B. anthracis*, and tests on over 30 additional strains were initiated.

- Initiated development of a new assay system based on bacterial ATP content as a rapid metabolic measure of antibiotic effects.

Diagnostics

- Discovered two types of insertion sequences in *B. mallei*, which may serve as useful diagnostic probes for pathogenicity.

Toxin Agents

The countermeasures, technical barriers, and accomplishments in the biological threat category of toxins are outlined below.

Countermeasures:

- Vaccines that produce long term protective immunity against toxin agents.
- Drugs that can be administered prior to toxin exposure and protect against toxin agents.
- Therapeutics for treatment of diseases/symptoms caused by toxin agents

Technical Barriers:

- Develop appropriate model systems that emulate human aerosol exposure and intoxication.
- Methods for induction of respiratory and mucosal immune responses that produce long term protective immunity at the agent's port of entry.
- Development of markers of pulmonary inflammation in animal models.
- Identification and development of appropriate animal models for investigation of surrogate endpoints of human clinical efficacy
- Retention of toxin antigenicity without toxic properties for vaccine candidate
- Insertion of stable genetic alteration of toxin biological targets to produce toxin-resistant biological targets.
- Generic protection from families of toxins with subtle alterations in toxic modes of action.
- Necessity to enhance the otherwise limited data on which to base rational drug and antibody therapies for toxin agents of interest.
- Necessity to establish and maintain capabilities to assess threats and provide countermeasures for new and emerging toxin threats.

Accomplishments:

Vaccines:

- Recombinant vaccine candidates against botulinum neurotoxin serotypes A, B, C, and F transitioned to JVAP/Prime System Contractor at Milestone I on September 10, 1999.
- Completed development of vaccine candidates for botulinum toxin serotype E as part of ORD.
- Completed development of vaccine candidates for botulinum toxin serotypes D and G.

- Focused on increasing the immunogenicity for botulinum vaccines for serotypes E and F.
- Showed that recombinant SE vaccines protected mice against sepsis infection by *Staphylococcus aureus*.
- Initiated SEB mucosal immunization studies using *Streptococcus gordonii*, cholera toxin, and hepatitis virus-like particles as delivery platforms.
- Demonstrated oral or nasal mucosal vaccination elicits protective antibodies against a lethal aerosol and intraperitoneal SEB challenge.
- Completed thirty-six month stability assessment on chemically deglycosylated ricin A chain vaccine candidate.
- Completed general safety, acute and repeat dose toxicity tests on chemically deglycosylated ricin A chain vaccine candidate.
- Established efficacy of chemically deglycosylated ricin A chain vaccine candidate in an aerosol challenge rodent model.
- Prepared information package to address suitability of the chemically deglycosylated ricin A chain vaccine candidate for human use with the FDA and industry.
- Developed models to evaluate ricin A chain subunit genetic enzymatic inactivation.
- Developed procedures to purify recombinant genetically inactivated ricin vaccine candidate.
- Selected one first generation recombinant staphylococcal enterotoxin vaccine candidate to recommend for transition to advanced development.
- Produced to GMP requirements the first recombinant vaccine candidate for staphylococcal enterotoxin type B.
- Prepared working cell banks and reference standards for the recombinant SE serotype A candidate in preparation for GMP production.
- Developed strategic preclinical assays for biological potency, formulation, and stability studies to support SE vaccine effort.
- Developed methods based on scanning and isothermal calorimetry for the physical characterization of recombinant staphylococcal enterotoxin vaccines used for formulation and stability studies of pre-GMP material.
- Completed adjuvant-vaccine co-formulation study for rSEB vaccine candidate.
- Evaluated efficacy of low dose recombinant SEB vaccine in rhesus monkeys against wild-type SEB.
- Characterized candidate vaccines for SEC1 and SED.
- Completed rSEB vaccination dosing and scheduling study in nonhuman primates; results will form the basis for recommendations of dose and schedule for human clinical trials.
- Demonstrated that the T-lymphocyte assay was useful in predicting the probability of survival in rhesus monkeys vaccinated with recombinant SEB vaccine and challenged by the aerosol route.
- Showed that the recombinant SEB vaccine protected T cells from becoming anergic in response to wild-type SEB in rhesus monkeys.
- Completed *in vitro* experiments establishing delivery of recombinant vaccines using mouse mesenchymal stem cells that differentiate into antigen presenting cells *in vivo*.
- Established human CD4 and human leukocyte antigen (HLA)-DR1, DR3, DQ6, and DQ8 transgenic colonies, class II-deficient mice. Showed that the lymphocytes obtained

from the humanized mice and humans reacted similarly to various biological threat agents.

- Developed a new surrogate assay for evaluating human immune responses based on dendritic cell cultures.
- Developed quantitative ELISA and *in vitro* neutralization assay for measurement of anti-ricin antibody to evaluate immune response in humans following vaccination.
- Developed *in vitro* protein evolution method based on bacteriophage-display for discovering new recombinant vaccines.

Therapeutics:

- Development of an *in vitro* model for screening novel competitive inhibitors as therapeutic agents for botulinum B toxin poisoning.
- Determined first complete, high-resolution three-dimensional crystal structure, for this family of botulinum neurotoxins (serotype A at 3.2 Angstroms) to be used as a foundation for further rational therapeutic drug design.
- Developed recombinant, enzymatically active, light chain for serotype A as a reagent for efforts focused on therapeutic countermeasures to botulinum neurotoxins.
- Demonstrated *in vitro* functional efficacy of replacement of cleaved botulinum target with botulinum-resistant SNAP-25 via protein/DNA technologies.
- Demonstrated that cells intoxicated by botulinum neurotoxin can be rescued and normal function restored by the intracellularly application of genetically engineered toxin-resistant protein or DNA.
- Demonstrated ability to target delivery into cholinergic nerves using the non-toxic botulinum serotype A transporter.
- Identified low molecular weight inhibitors of botulinum neurotoxin protease for serotypes A and B.
- Refined mass spectroscopy techniques using hydrogen-deuterium exchange to quantify protein structural components in botulinum neurotoxin targeted substrates and correlated them with other spectroscopic techniques.
- Used neutron scattering (in collaboration at the Department of Commerce, National Institute of Standards and Technology) to quantitatively examine BoNT's interaction with biological membranes and BoNT's channel-forming structure.
- Developed and refined computational chemistry techniques to thermodynamically evaluate protein-ligand interactions that will be used in screening massive chemical databases for compounds as potential inhibitors of BoNT enzymatic activity.
- Synthesized a short polypeptide that is the most potent inhibitor known (2 uM) for type A botulinum neurotoxin. This polypeptide will be used as a new lead compound for future combinatorial organic synthesis and high throughput screening for high affinity inhibitors.
- Developed high-throughput assays, suitable for screening large numbers of compounds for inhibitors of botulinum toxin proteolytic activity.
- Developed biosensor-based method to measure staphylococcal enterotoxin-receptor interactions for screening inhibitory molecules.
- Developed nonhuman primate incapacitation SE model.

- Demonstrated that passive transfer of antibody protects mice and nonhuman primates from the effects of SEB.
- Produced panels of reagent grade monoclonal antibodies to SE types A, B, C1, and D, which neutralized toxin activity *in vitro*.
- Developed computational model for rational drug design based on the co-crystal three-dimensional structure of SE type C3 and the T-cell receptor.
- Cloned and expressed genes that encode the major alleles of streptococcal and staphylococcal pyrogenic exotoxins.
- Developed and refined a novel fluorescence-based, cell-free enzymatic assay for evaluating ricin toxicity and screening potential inhibitors.
- Completed binding studies with *C. perfringens* iota toxin, a binary toxin and potential vehicle for delivering therapeutic agents to counteract the ill effects of botulinum, or other, toxins.
- Characterized toxicity of *C. perfringens* toxin types A, B, C, D, and E when administered to mice and rats by parenteral or aerosol routes, and found that toxicity was highly dependent on the toxin type and route of administration.
- Determined that spores and exotoxin of *C. perfringens* type A cause disease in parenterally inoculated mice and rats.
- Determined that the inhaled organism, spores or exotoxins are not pathogenic in mice, rats or hamsters.
- Initiated collaborative efforts to evaluate the anaerobic bacterial origins of saxitoxin.
- Initiated experiments to dissect the mechanism of action of lethal toxin of *B. anthracis* at molecular level; results suggest that MAP kinase family may not be the only target for the lethal toxin.
- Cloned and expressed single-chain class II receptors with covalently linked peptide for use as biomarkers for the study a variety of therapeutics against biological threat agents.

Viral Agents

The countermeasures, technical barriers, and accomplishments in the biological threat category of viral agents are outlined below.

Countermeasures:

- Vaccines for immunity against viral threat agents.
- Antibodies and antiviral drugs for treatment of viral disease.

Technical Barriers:

- Difficulty in optimizing and comparing different expression vectors for recombinant products (vaccines and antibodies).
- Need for rapid virus identification technology.
- Insufficient or incompletely understood animal model systems for investigation of viral threats and countermeasures.
- Necessity to develop and fully characterize animal models for eventual licensure of vaccines for which epidemiological realities disallow the possibility of efficacy data from human clinical trials.

- Need for multivalent vaccines and compatible vaccine platforms to protect against an array of unrelated viral agents.
- Difficulty with some agents in defining surrogate markers of protection.
- Necessity to enhance the otherwise limited data on which to base rational drug and antibody therapies for viral agents of interest.
- Necessity to establish and maintain capabilities to assess threats and provide countermeasures for new, emerging, and genetically engineered hazardous viruses.

Accomplishments:

Vaccines:

- Demonstrated in animal models that improved mucosal protection against Venezuelan equine encephalitis virus is induced by the molecularly defined, live-attenuated V3526 vaccine candidate.
- Demonstrated that subcutaneous administration of V3526, the candidate replacement vaccine for VEE subtype IA/B, induced systemic and mucosal protection more efficiently than the TC-83 vaccine currently available under IND; protection from lethal subcutaneous or aerosol challenge was evaluated in vaccinated mice clinically and immunohistochemically.
- Demonstrated the potential for wider utility of a promising BW defense vaccine platform by showing that VEE virus replicons expressing influenza HA protect alphavirus-immune mice from intranasal challenge.
- Showed that neurovirulence and tissue tropism of wild-type and attenuated strains of Venezuelan equine encephalitis virus were distinguishable in mice, the attenuated viruses (including vaccine candidates) having restricted tissue tropism compared to wild-type virus.
- Determined that pre-existing immunity to Eastern equine encephalitis virus, which interferes with the TC-83 Venezuelan equine encephalitis virus vaccine, does not interfere with the induction of VEE virus replicon-induced protection to influenza (HA-vaccinated) or Ebola virus (GP-vaccinated) in mice.
- Identified protective monoclonal antibody specific for the E3 protein of Venezuelan equine encephalitis virus.
- Began characterization of monoclonal antibodies to Western equine encephalitis virus (WEE), in order to define more precisely the requirements and immunological markers of WEE immunity.
- Produced and characterized human monoclonal antibody Fab fragments to vaccinia virus from a phage-display combinatorial library, and initiated an effort to exploit this technology for the production of antibodies useful in immunotherapy.
- Showed that DNA vaccination, with genes encoding the vaccinia virus proteins L1R and A33R, protects mice against a lethal poxvirus challenge.
- Constructed additional experimental vaccines, in both DNA and replicon vaccine platforms, for testing of individual vaccinia virus proteins that are candidates to elicit immunity to medically important orthopoxviruses.
- Used cDNA microarrays to document the induction of cytokine gene expression in Ebola virus-infected human monocytes, providing data on the possible influence of enhanced cellular gene expression in contributing to the pathogenesis of Ebola virus disease.

- Used cDNA microarrays to compare cellular gene expression in Ebola-Zaire and Ebola-Reston virus-infected primary human monocytes, and found different patterns of gene expression induced by highly virulent and putatively avirulent strains of Ebola virus.
- Demonstrated that just two vaccinations with Ebola GP or NP DNA, delivered by gene gun, were sufficient to provide 100% protection in mice challenged with Ebola virus, showing that greater levels of immunogenicity and protective efficacy, with fewer vaccinations, can be achieved than we previously reported.
- In a collaborative study with WRAIR scientists, showed that cytotoxic T lymphocytes to Ebola Zaire virus are induced in mice by immunization with liposomes containing lipid A.
- Demonstrated durable immunity to Marburg virus by showing that nonhuman primates, which had been immunized one year previously and survived an otherwise lethal with Marburg virus, were resistant to re-challenge with the same strain of virus.
- Demonstrated that, in monkeys as shown previously in guinea pigs, the single most protective Marburg virus antigen may be insufficient by itself to protect against a distantly related strain of the virus, and that another antigen may be required in a broadly protective vaccine.
- Constructed a replicon-based Marburg virus vaccine containing glycoprotein from a strain of virus most distinct from the prototype, in order to begin to optimize antigenic content of a broadly protective Marburg virus vaccine.
- Demonstrated protective efficacy and immunogenicity in animal model systems with VEE replicons making the non-toxic 50 kDa carboxy-terminal fragment of the botulinum neurotoxin type A heavy chain (Hc), thereby providing data to support the safe and effective use of the VEE virus replicon as a vaccine vector.
- Showed the conceptual potential for multi-agent vaccines by demonstrating, in rodent models, that recombinant VEE RNA replicon vaccines provide efficient protection against Ebola, Marburg, influenza, Lassa, and Rift Valley fever viruses, as well as *B. anthracis* and botulinum neurotoxin.
- Showed conceptual potential for multi-agent vaccines by constructing and demonstrating efficacy in rodents with naked DNA vaccines for the *hantaviruses*—Seoul virus and Hantaan virus; the *filoviruses*—Ebola virus and Marburg virus; and the *flaviviruses*—Russian Spring Summer encephalitis virus and Central European encephalitis virus.
- Demonstrated expression, processing, and protective efficacy in mice of the structural proteins of Venezuelan equine encephalitis virus (VEE), made from recombinant baculovirus vectors
- Conducted arbovirus field ecology Studies in the Amazon Basin region of Peru, discovering several viruses in circulation including Eastern and Venezuelan equine encephalitis viruses, relevant to vaccine development efforts.

Therapeutics:

- Developed a method for genotyping and quickly identifying orthopoxviruses, by exploiting long-distance polymerase chain reaction (PCR) and restriction fragment polymorphism.
- Showed that Cidofovir[®] protects mice against lethal intranasal or aerosol cowpox virus challenge.

- Showed that Cidofovir[®] is a potential antiviral therapeutic agent for the treatment of smallpox and monkeypox infections, active against smallpox *in vitro* (work done by USAMRIID scientists at the CDC) and against monkeypox in nonhuman primates.
- Identified protective monoclonal antibodies to Ebola virus and the epitopes they bind, thereby showing the conceptual feasibility of antibody therapy and the worthiness of antibody induction by Ebola vaccines.
- Expanded a collaboration with Abgenix, Inc., to test the utility of their Xenomouse (TM) technology in making fully human monoclonal antibodies for therapeutic use against both filoviruses (Ebola and Marburg viruses) and poxviruses (vaccinia virus).
- Demonstrated that recombinant human interferon alpha hybrid B/D protects mice against lethal Ebola virus infection.
- Showed that S-adenosylhomocysteine hydrolase inhibitors inhibit Ebola virus *in vitro* and in a lethal mouse model, establishing a possible route toward antiviral drug therapy of filovirus infections.

Diagnostic Assays for Biological Warfare Threat Agents

The accomplishments in the diagnostic assays for biological warfare threat agents are outlined below. The objective of this effort is to develop the capability to confirm in biological samples the initial field diagnosis of a biological warfare threat agent.

Countermeasures:

- Forward deployed, hand-held common diagnostic device.
- Field laboratory capability to identify biological threat agents.
- Reference laboratory for confirmation diagnostics.

Technical Barriers:

- Difficulty in field testing rapid identification kits under natural conditions.
- Lack of rapid confirmatory assays with “gold standard” sensitivity and specificity.
- Limited rapid deployable identification technology.

Accomplishments:

- Developed a plan and a strategy for multi-gene and multi-agent identification of disease pathogens.
- Developed a research plan in collaboration with Cepheid, Inc. to develop high throughput system for biological or environmental sample processing.
- Developed a research plan with Nanogen, Inc. to develop an arrayable electronic system for gene detection.
- Showed that a panel of mouse monoclonal antibodies, made previously, includes antibodies potentially useful in the detection of multiple proteins shared among orthopoxviruses that are human pathogens.
- Demonstrated TaqMan[™] (5' fluorescence-based probe hydrolysis) PCR assays capable of detecting between 10 and 1000 gene copies per reaction for the following agents: *B. anthracis* (6 assays), *Brucella*, *C. burnetii*, *F. tularensis*, *Y. pestis*, orthopox-

viruses (monkey pox, vaccinia and variola viruses), *C. botulinum* toxins A and B, and the simulants *Erwinia herbicola* and MS2 phage.

- Demonstrated PCR assays compatible with the Light Cycler™ rapid nucleic acid analysis device for the following agents: *B. anthracis*, *Y. pestis*, *C. botulinum* toxins A and B, orthopox virus, and the simulants *B. globigii* and *E. herbicola*.
- Demonstrated PCR assays compatible with the portable, battery-powered SmartCycler™ rapid nucleic acid analysis device for the following agents: *B. anthracis* (2 assays), *Clostridium* toxin A and B genes, *C. burnetii*, *F. tularensis*, and staphylococcus enterotoxin A and B genes.
- Evaluated portable, battery-powered, rapid nucleic acid analysis devices that can detect biological agents in less than 40 minutes after sample processing in a field deployable laboratory.
- Demonstrated rapid specimen processing of whole blood in less than 30 minutes using a portable automated device.
- Demonstrated solid phase methods for the rapid purification of nucleic acids without hazardous chemicals.
- Demonstrated rapid lysis of *B. anthracis* spores in less than 1 min using sonication in a closed cartridge prototype and purification of nucleic acids in less than 50 minutes.
- Evaluated dry down and stable reaction chemistries for gene amplification assays.
- Demonstrated increased sensitivity of electrochemiluminescence assays to detect ricin toxin, *C. botulinum* toxins, *Y. pestis* F1 antigen, staphylococcal enterotoxin A, and *B. anthracis* PA antigen to the femtogram level.
- Demonstrated that anthrax spores can be detected by swab sampling of the nose, face and hairy portions of the face in an animal model within 24 hours after exposure.
- Demonstrated a new isothermal gene amplification (non-PCR) detection method and specimen processing cartridge for the rapid identification of *Y. pestis*.
- Collaborating with Lawrence Berkeley National Laboratory on chromosomal DNA markers for the identification of *B. anthracis*. Developing PCR diagnostic assays based on markers identified.
- Developed specific antigen capture ELISA assays, under the auspices of the Common Diagnostics DTO, for *B. pseudomallei*, *C. perfringens*, Rift Valley fever virus, yellow fever virus and Dengue 2 virus using a rabbit and goat polyclonal antibodies as well as monoclonal antibodies.
- Developed improved monoclonal antibodies specific for *V. cholera* to use in an antigen capture ELISA assay.
- Developed a specific antigen capture ELISA assay for vaccinia virus using rabbit polyclonal and human recombinant antibodies.
- Developed a specific immunochromatographic hand-held assay for *C. perfringens* enterotoxin, Rift Valley fever virus, and Dengue 2 virus.
- Used the bidiffractive gating biosensor assay to detect the simulants ovalbumin and *B. globigii* at a joint field trial.
- Demonstrated sensitive immunodetection of *B. anthracis* PA antigen using time resolved fluorescence.
- Demonstrated effectiveness of recombinant Fab antibody in immunochromatographic hand-held assay for botulinum toxin A.

- Successfully substituted recombinant antibodies for monoclonal antibodies in current ELISA assays.
- Developed recombinant antibodies to *F. tularensis* and *Y. pestis* that are being incorporated into diagnostic assays.
- Demonstrated rapid methods for rapid nucleic acid analysis of orthopoxviruses by long PCR RFLP analysis.

D.2.3 Advanced Development Accomplishments

The Joint Program Office for Biological Defense (JPO-BD) is a DoD chartered agency to provide intensive centralized management of medical and non-medical programs to expedite materiel solutions for validated biological defense deficiencies. Vaccine products will be further developed by the Joint Vaccine Acquisition Program (JVAP), an ACAT II program under JPO-BD. Vaccines directed against high threat agents will be produced and stockpiled to fulfill a 1.2 million Troop Equivalent Doses (TEDs) requirement (Note: TED = the amount of vaccine required to immunize a service member to protect against a biological warfare agent.) Vaccines against low threat agents will be produced to fulfill a 300,000 TEDs requirement.

The following products have transitioned from the technology base to advanced development and are managed and funded by JPO-BD.

D.2.3.1 Botulism Immune Globulin (Human), Pentavalent (IND #1332)

- The IND remains open to accommodate emergency treatment requirements for exposure or possible exposure to botulinum toxin types A, B, C, D, or E.

D.2.3.2 Botulinum Type F Toxoid Vaccine (IND #5077)

- Completed the Phase 2 Safety and Immunogenicity clinical study of Botulinum Type F Toxoid Vaccine. The purpose of this study was to identify a vaccination schedule and route of vaccination that is safe and maximally immunogenic.
- A final report for the Phase 2 safety and immunogenicity clinical study was completed.
- Work has been stopped on the development of this product because it did not meet user requirements

D.2.3.3 Anthrax Vaccine Human Adsorbed

- The sale of Michigan Biologic Products Institute (MBPI) by the state of Michigan was finalized. MBPI was purchased by BioPort, which consists of the management team from MBPI and outside capital; it is a private sector entity without state of Michigan affiliation.
- Managed and funded efforts leading to the submission of a Biologic Licensure Application amendment to the FDA for Anthrax Vaccine Adsorbed. Data submitted to the FDA supports two separate efforts for the vaccine: (1) to reduce the current six-dose

schedule to a five-dose schedule, and (2) to license the vaccine to provide protection against aerosol exposure to anthrax.

- Managed the anthrax vaccine production and stockpile to ensure sufficient vaccine is available to support the Secretary of Defense's anthrax immunization efforts.
- DoD continued to provide technical assistance to BioPort to identify and correct FDA compliance issues.
- Funded and provided oversight of production facility upgrades and ancillary support function renovation at BioPort that are critical to maintaining anthrax vaccine availability.

D.2.3.4 Botulinum (Pentavalent) Toxoid Adsorbed (ABCDE) (IND#3723)

- A total of 348 volunteers were immunized under a clinical protocol in support of licensure application.
- A clinical protocol for a follow-on booster study was initiated.

D.2.3.5 Botulism Immune Globulin F(ab')₂, Heptavalent, Equine, Types A, B, C, D, E, F, & G IND (#7451)

- Contracted for continued stability testing of the product.
- Completed Phase 1 Safety and Pharmacokinetics clinical study.
- Provided Botulinum Antitoxin Standards to Battelle Medical Research and Evaluation Facility used for the development of the Pentavalent Botulinum Toxoid (ABCDE).
- Stability testing was conducted for this IND product.

D.2.3.6 Botulism Immune Globulin (Human), Pentavalent (IND #1332)

- The IND remains open to accommodate emergency treatment requirements for exposure or possible exposure to botulinum toxin types A, B, C, D, or E.

D.2.4 Joint Vaccine Acquisition Program (JVAP) Accomplishments

D.2.4.1 Prime Systems Contract

- The Secretary of the Army approved indemnification for the prime systems contractor.

D.2.4.2 Contingency Stockpile of Biological Defense (BD) Vaccines

- Stability testing capability to support continuing use of the Investigational New Drug (IND) stockpile has been established at Southern Research Institute (SRI), Frederick, Maryland facility. SRI, a sub-contractor to DynPort, LLC, has completed annual stability tests on all IND lots of Tularemia, Q-Fever, VEE, EEE, and WEE IND vaccines.

D.2.4.3 Advanced Development of the Tularemia Vaccine

- Under contract to Life Sciences Division, Dugway Proving Ground (DPG), the selected National Drug vaccine candidate was resuscitated on glucose cysteine blood agar and transparent PCA medium.
- Using the oblique light technique, the resuscitated cultures consisted primarily of the immunogenic blue phenotype necessary for vaccine development.
- A research seed was produced under contract to Life Sciences Division, DPG, for transfer to a GMP-compliant facility for production of master and working seed banks.
- Work started on animal model for safety at Defense Evaluation Research Agency (UK).

D.2.4.4 Advanced Development of the Q-fever Vaccine

- A site inspection of the selected manufacturing sub-contractor in Australia was conducted.
- Facility and product pre-IND meetings were held with the FDA.

D.2.4.5 Advanced Development of the Smallpox Vaccine

- Continued to review historical records and to identify technical and regulatory issues to form the basis for a scientifically sound, feasible plan for the advanced development of a cell culture smallpox vaccine.
- Submitted a clinical protocol to the FDA to evaluate the candidate vaccine administered by scarification.
- Filed an IND with the FDA to insure continued availability of previously manufactured Vaccinia Immune Globulin (VIG), which will allow the clinical trial to proceed.
- A manufacturing and licensure effort for a new VIG product has begun.
- Continued discussions with the Department of Health and Human Services about the feasibility of scale-up production for the DoD vaccine to obtain for a civilian stockpile.

D.2.4.6 Venezuelan Equine Encephalitis Vaccine

- Transitioned infectious clone vaccine candidate into advanced development.

D.2.4.7 Recombinant Botulinum Toxin Vaccine

- Transitioned monovalent botulinum toxin vaccine candidates into advanced development.

D.2.4.8 International Cooperative Research and Development

- The JVAP Project Management Office (PMO) continued technical discussions with representatives of the United Kingdom and Canada about cooperative research and development agreements for Biological Defense vaccine products. As a result of these discussions the JVAP PMO has developed U.S. documentation outlining a proposed

strategy and approach in negotiating a Tri-National Project Arrangement with the UK and Canada.

- The JVAP PMO participated extensively with the Medical Biological Development Research Directorate to achieve a Milestone 0 decision by the Medical Research Material Command (MRMC) to continue development of both U.S. and UK plague vaccine candidates. Each country will independently fund continued development of these vaccine candidates though at least to a Milestone I decision. This process will establish common exit criteria for a Milestone I decision.

D.2.4.10 Integrated Digital Environment (IDE)

In order to meet the Under Secretary of Defense for Acquisition, Technology & Logistics mandate to transition acquisition activities to an IDE by 2002, and to achieve the streamlining and savings associated with the mandate, a comprehensive plan to transition JVAP PMO acquisition activities to an Integrated Digital Environment was developed and approved by JPM-BD. As part of this effort, the JVAP-PMO established a high-speed direct data transmission line with DynPort, LLC that forms the basis for the IDE.

D.3 MEDICAL NUCLEAR (RADIOLOGICAL) DEFENSE RESEARCH PROGRAM

D.3.1 Fielded Products

Advances in medical R&D significantly effect the warfighting mission by sustaining unit effectiveness through conserving the fighting strength of our service members. The individual service member whose performance is decremented by illness is significantly more likely to become a traumatic casualty. In this era of small, but highly lethal forces, loss of only a few team members can dramatically diminish a unit's capability. Medical R&D products (materiel and non-materiel solutions) provide the foundation that ensures the fielding of a flexible, sustainable, modernized force across the spectrum of conflict and in the full breadth and depth of the battlefield. Overcoming medical threats and extending human performance have provided a significant increase in military effectiveness in the past and present the potential for future enhancement on military operational effectiveness. Some of the materiel and non-materiel solutions developed for use by medical radiological defense R&D are:

- Cytokine-based therapeutic applications to prevent the two major fatal syndromes—sepsis and uncontrolled bleeding—following acute radiation injury.
- Cytogenetic biodosimetry service operating to measure individual radiation exposure using blood samples.
- NATO Handbook on the Medical Aspects of NBC Defensive Operations, Volume 1-Nuclear (AMedP-6).
- Medical Effects of Ionizing Radiation (MEIR) Course—Training for approximately 350 Medical Department personnel in FY99.
- Videotapes and CD-ROM of MEIR course lectures produced for distribution to military medical units.

D.3.2 Nuclear Defense Research and Development Accomplishments

The nuclear (or radiological) defense research and development technical barriers and accomplishments during FY98 are grouped in the following threat categories:

- Prompt high-dose radiation.
- Protracted low-dose radiation.
- Combined radiation and chemical or biological agents.

“Prompt high-dose radiation” refers to the deposition of high levels of ionizing radiation energy in biological tissues in very short periods of time. Sources of high-energy radiation include emissions within the first 60 seconds of a nuclear weapon detonation and “criticality events” that occur when a nuclear reactor achieves peak energy output either accidentally or through an intentional act. The high linear-energy-transfer imparted by the neutrons of these sources causes significant tissue injury within seconds of exposure, resulting in both short and

long-term health consequences.

“*Protracted low-dose radiation*” refers to the deposition of low-energy radiation energy in biological tissues over extended periods of time. Sources of low-energy radiation include fall-out from nuclear weapon detonations, radiological dissemination devices, and any other source of environmental radiation contamination. Health consequences are generally intermediate to long-term and result from cumulative tissue injury accruing over time due to chronic exposure. Health consequences can be exacerbated further when radionuclides are deposited internally by ingestion, inhalation or through open wounds in the external integument.

“*Combined ionizing radiation and either chemical or biological agents*” refers to the amplified health consequences when chemical or biological insults are incurred in conjunction with radiological injury. Both clinical and non-clinical exposures to ionizing radiation compromise host defenses against a variety other stressors, including infectious agents and chemical toxicants. Exposures to doses of radiation and infectious or chemical agents that are by themselves sublethal can produce mortality rates of nearly 100% when combined.

The Medical Radiological Defense Research Program focuses on developing medical countermeasures to the health consequences of both prompt high-dose and protracted low-dose exposures to ionizing radiation. It also develops experimental data detailing combined NBC medical effects needed by computer modeling programs for casualty prediction. Specific research on medical countermeasures includes work on prophylactic and therapeutic drugs, drug delivery devices to enhance efficacy and simplify administration under field conditions, and combined prophylactic/therapeutic protocols to further enhance efficacy. Work also focuses on developing novel biological dosimetry techniques to measure individual absorbed doses. Knowledge of the dose of radiation absorbed helps guide medical treatment decisions and saves lives. It also provides field commanders with an assessment of the radiological health of deployed forces and leads to better-informed operational decision making.

Threat Category: Prompt High Dose Radiation

The countermeasures, technical barriers, and accomplishments in the threat area of prompt high dose radiation are outlined below.

Countermeasures:

- Advanced medical treatment strategies for radiation injuries.
- Drugs designed to increase resistance of soldiers to radiation and protect the soldier against radiation injury without compromising performance.
- Drugs designed to prevent the onset of radiation-induced performance decrements such as fatigue, nausea and vomiting.
- Biological dosimetry techniques for rapid injury assessment needed to guide medical treatment decisions and assessment of radiological health of combat units.

Technical Barriers:

- Need to minimize the performance-degrading effects of prophylactic drugs that otherwise have good efficacy for the prevention of radiological injury.
- Need to advance knowledge of cellular, sub-cellular, and molecular mechanisms of radiological injury to improve rational development of prophylactic and therapeutic drugs.
- Need to increase prophylactic drug stability in order to improve bioavailability and to enhance drug efficacy.
- Need for extending the stability of a prophylactic drug to allow its use in a slow-release delivery device for extended bioavailability and enhanced efficacy.
- Difficulty in identifying and calibrating biological markers that can both indicate the amount of absorbed radiation dose and differentiate whole-body from partial-body exposure.
- Inability to automate sample preparation and reducing sample preparation times of cytogenetic biodosimetry tests.

Accomplishments:

- Determined in preliminary studies that non-androgenic forms of androstene steroids represent a novel class of effective, nontoxic radioprotectants.
- Continued assessment and optimization of a combined radioprotectant, cytokine, and clinical support treatment modalities for enhancing survival following acute, lethal irradiation.
- Demonstrated the therapeutic advantage of combining two recombinant cytokines (IL-11 and G-CSF) into a single postexposure treatment of acute radiation injury.
- Completed initial experiments showing therapeutic efficacy with the novel use of a tissue-repair cytokine, keratinocyte growth factor, to manage radiation-induced gastrointestinal tissue injury and associated blood infections following exposure.
- Developed new prophylactic strategy for reducing acute radiation injury based on (a) low-toxicity drug selection, (b) pharmacologic quenching to further reduce toxic side effects, and (c) new drug delivery alternatives.
- Developed a novel high-throughput and rapid cytogenetic-based bioassay to assess biologically absorbed radiation dose over a broad dose range.
- Completed development of automated metaphase-finding software/hardware system for cytogenetic-based bioassays. Sample throughput is increased 3-fold and accuracy is significantly improved.

Threat Category: Protracted Low Dose Radiation

Countermeasures, technical barriers, and accomplishments in the area of protracted low dose radiation from nuclear fallout, radiological explosive devices, *etc.*, are outlined below.

Countermeasures:

- Advanced medical treatment strategies for protracted radiation to mitigate injuries from both external and internal sources of radioactivity.
- Drugs designed to protect personnel from the early and late effects of ionizing radiation

without compromising performance pharmacologic intervention strategies that protect against both early and late health effects arising from cellular and molecular damage caused by ionizing radiation.

- Improved techniques to detect and remove internally deposited sources of radioactivity
- Improved drug delivery systems that provide non-encumbering protection during the entire period of radiation exposure.
- Enhanced biodosimetry technique that can differentiate prior from recent exposures to radiation.

Technical Barriers:

- Lack of suitable radiation sources to study the effects of chronic exposure at relevant doses.
- Difficulty in manipulating cellular repair mechanisms.
- Toxicity of chelating agents used to remove sources of radioactivity.
- Brief periods in which traditional radioprotective drugs are active.
- Toxicity of radioprotective drugs used over protracted periods of time. Limited knowledge of DNA damage surveillance and repair mechanisms under protracted exposure conditions hinders development of pharmacologic agents to prevent late-arising cancers.
- Need to reduce the toxicity of heavy metal chelating agents while maintaining their efficacy.
- Need to extend bioavailability of prophylactic drugs to achieve maximum long-term protection.
- Potential cumulative toxicity of prophylactic drugs (antimutagenic and anticarcinogenic agents) when used for extended periods.
- Lack of a sustained drug delivery system of radioprotectants.
- Microbial resistance to antibiotics.
- Difficulty in identifying a persistent biological marker that indicates the amount of absorbed radiation dose for both recent and prior exposures.

Accomplishments:

- Identified a promising new, broad-spectrum, nontoxic pharmacologic that protects against radiation's cancer-inducing effects.
- Developed a foundation for an improved prophylactic strategy based on a better understanding of basic molecular and cellular mechanisms of the long-term consequences of prior radiation-induced tissue damage and repair.
- Established a drug assay to monitor effectiveness of slow-release radioprotective drugs under study.
- Developed novel protocols that leverage the quantitative precision and accuracy of a fluorogenic 5' nuclease PCR procedure to measure molecular responses to radiation and demonstrated that oncogene expression and mitochondria DNA deletions may represent new biological markers for quantifying radiation exposure.

Threat Category: Combined Ionizing Radiation and Either Chemical or Biological Agents

The countermeasures, technical barriers, and accomplishments in the threat area of combined effects of nuclear ionizing radiation with trauma, burns, infection, or chemical toxicants radiation and trauma, burns, and infection are outlined below.

Countermeasures:

- Therapeutic agents designed to decrease morbidity and mortality from multi-organ system failure due to the combined effects of radiation, trauma, burns, and infection or chemical toxicants.
- Radioprotective drugs designed to harden the soldier against the effects of radiation in combination with trauma, burns, infection, or chemical toxicants.
- Combined therapeutic agents designed to decrease morbidity and mortality from combined exposures and to enhance innate immune responses.
- Computer models for predicting casualties following combined exposure to low levels of ionizing radiation and biological warfare/chemical warfare agent aerosols.

Technical Barriers:

- No surrogate models for extrapolating data to humans.
- Limited animal models that are optimum for both radiation and a biological warfare or chemical warfare agent.
- Need to gain access to radiation sources and biological containment facilities in order to complete full range of experiments on combined effects of radiation and BW agents.
- Growing number of microbial organisms resistant to antibiotics.
- Accounting for variability in sensitivities of biological systems to different radiation qualities (e.g., neutron vs. gamma radiation).
- Mechanism of action of cell-growth factors is not well understood.
- Sensitivity of bone marrow progenitor cells to low doses of ionizing radiation.

Accomplishments:

- Determined in rodent model that sub-lethal exposures to ionizing radiation and intratracheal-delivered spores of *B. anthracis* (Sterne) cause 60% to 20% increased mortality in naïve and vaccine-immune populations, respectively.
- Demonstrated for the first time in an animal model that combined exposure to a sublethal dose of radiation and *B. anthracis* spores (Sterne) results in opportunistic systemic infection from translocated enteric bacteria.
- Established capability to integrate health consequences of radiation/biological warfare agent interactions, extrapolated from animal model studies, into the Consequence Assessment Tool Set (CATS).
- Established the LD_{50/30} of gamma radiation in the euthymic hairless rodent as a model for studies of the effects of combined exposure to radiation and mustard blistering agents.
- Demonstrated a 10,000-fold reduction of the LD_{50/30} to mice from intraperitoneal challenge with Venezuelan Equine Encephalomyelitis (VEE) virus if the mice are first exposed to a sublethal dose of ionizing radiation.

D.3.3 Predevelopment Products

Technical developments in predevelopment products for medical radiological defense include the following:

- Androstene steroids as broad spectrum, nontoxic radioprotectants.
- “Slow release” radioprotectant for extended periods of protection.
- Cytokine therapeutic for the effective treatment of acute radiation injury of the gastrointestinal system.
- CATS model enhancements to incorporate radiation/BW interactions.
- Product improvement of the cytogenetic biodosimetry system by automation of satellite scoring subsystem to increase sample throughput.
- Rapid and sensitive method to measure urinary uranium concentration.

(INTENTIONALLY BLANK.)

Annex E

DoD Joint Service Chemical and Biological (CB) Defense Program Funding Summary

In accordance with 50 USC 1522, *Department of Defense Chemical and Biological Defense Program*, research, development, test and evaluation (RDT&E) and procurement for all DoD chemical and biological (CB) defense programs (with the exception of those biological warfare defense RDT&E programs conducted by the Defense Advanced Research Projects Agency, DARPA) are consolidated into defense-wide program element (PE) funding lines. Detailed funding information previously contained in this annex is provided annually to Congress in the DoD Joint Service Chemical and Biological Defense Program, President's Budget Submission, Research, RDT&E, Defense-Wide and Procurement, Defense-Wide budget exhibits, and in the Department of Defense Extract found in the Budget of the United States. These budget submissions provide a detailed account of prior year accomplishments and planned activities for the budget request period. Table E-1 (and Figure E-1) provides a summary of appropriated and requested funding from FY 1996 – FY 2005. Fiscal year 1996 was the first year in which all Service and Defense Agency CB defense programs were consolidated into defense-wide funding lines. Prior to FY 1996, funding was included in several separate Service and Defense Agency funding lines. Also, during FY 1996 approximately \$30 million was transferred to the CB Defense Program procurement line from the Army's operations and maintenance (O&M) accounts for bio-defense vaccine acquisition. Much of the growth in program funding between FY 1996 and FY 1997 resulted from the transfer of funds between existing accounts rather than real growth in the overall DoD CB Defense Program.

Table E-2 provides a summary of expenditures by the DoD Chemical and Biological Defense Program. Expenditures represent the amount of checks issued or other payments made (including advances to others), net of refunds and reimbursements. The term is frequently used interchangeably with the term "outlays," which are the measure of government spending (*i.e.*, payments to liquidate obligations (other than the repayment of debt), net of refunds and offsetting collections.) It is important to note that funds appropriated for a given year may be expended incrementally over a period of years. Thus, expenditures shown in Table E-2 will be updated in following years to show total expenditures of appropriated funds.

Table E-1. Chemical and Biological Defense Program Appropriations Summary

Program Element (PE) (\$ millions)	FY96†	FY97†	FY98†	FY99†	FY00†	FY01*	FY02**	FY03**	FY04**	FY05**
0601384BP - Basic Research	26.492	28.372	25.263	28.505	44.040	33.197	30.990	30.004	30.973	31.969
0602384BP - Applied Research	68.571	70.823	69.632	62.301	97.400	73.600	83.185	84.480	74.872	76.467
0603384BP - Advanced Tech. Dev.	33.727	41.693	43.517	59.186	56.911	46.594	53.283	62.722	83.190	80.934
Science & Technology Base Subtotal	128.790	140.888	138.412	149.992	198.351	153.391	167.458	177.206	189.035	189.370
0603884BP - Demonstration/Validation	29.184	44.747	49.465	61.409	68.502	83.800	69.494	74.465	72.511	53.289
0604384BP - EMD	87.229	97.468	123.045	103.159	118.458	100.815	166.231	183.528	119.095	74.497
0605384BP - Management Support	6.954	17.936	21.137	25.099	24.553	23.907	24.515	25.009	24.667	25.385
0605502BP - Management Support/Small Business Innovative Research (SBIR)	0.000	0.000	5.612	5.638	0.000	0.000	0.000	0.000	0.000	0.000
RDT&E, Defense-Wide (D-W) Subtotal	252.157	301.039	337.671	345.297	409.864	361.913	427.698	460.208	405.308	342.541
0208384BP - Procurement, D-W Subtotal	135.647	232.952	233.943	295.189	381.156	473.936	425.870	440.165	486.037	518.767
CB Defense Program Total	387.804	533.991	571.614	640.486	791.020	835.849	853.568	900.373	891.345	861.308

† Total Obligation Authority (TOA)

* FY01 President's Budget Request

** Estimated [from FY01 President's Budget]

Table E-2. Chemical and Biological Defense Program Expenditures Summary

Program Element (PE) (\$ millions)	FY96†	FY97†	FY98†	FY99†
RDT&E, Defense-Wide	241.096	269.429	299.879	168.222
Procurement, Defense-Wide	125.803	199.476	162.202	72.375
CB Defense Program Total	366.899	468.905	462.081	240.597

† Expenditures as of September 30, 1999.

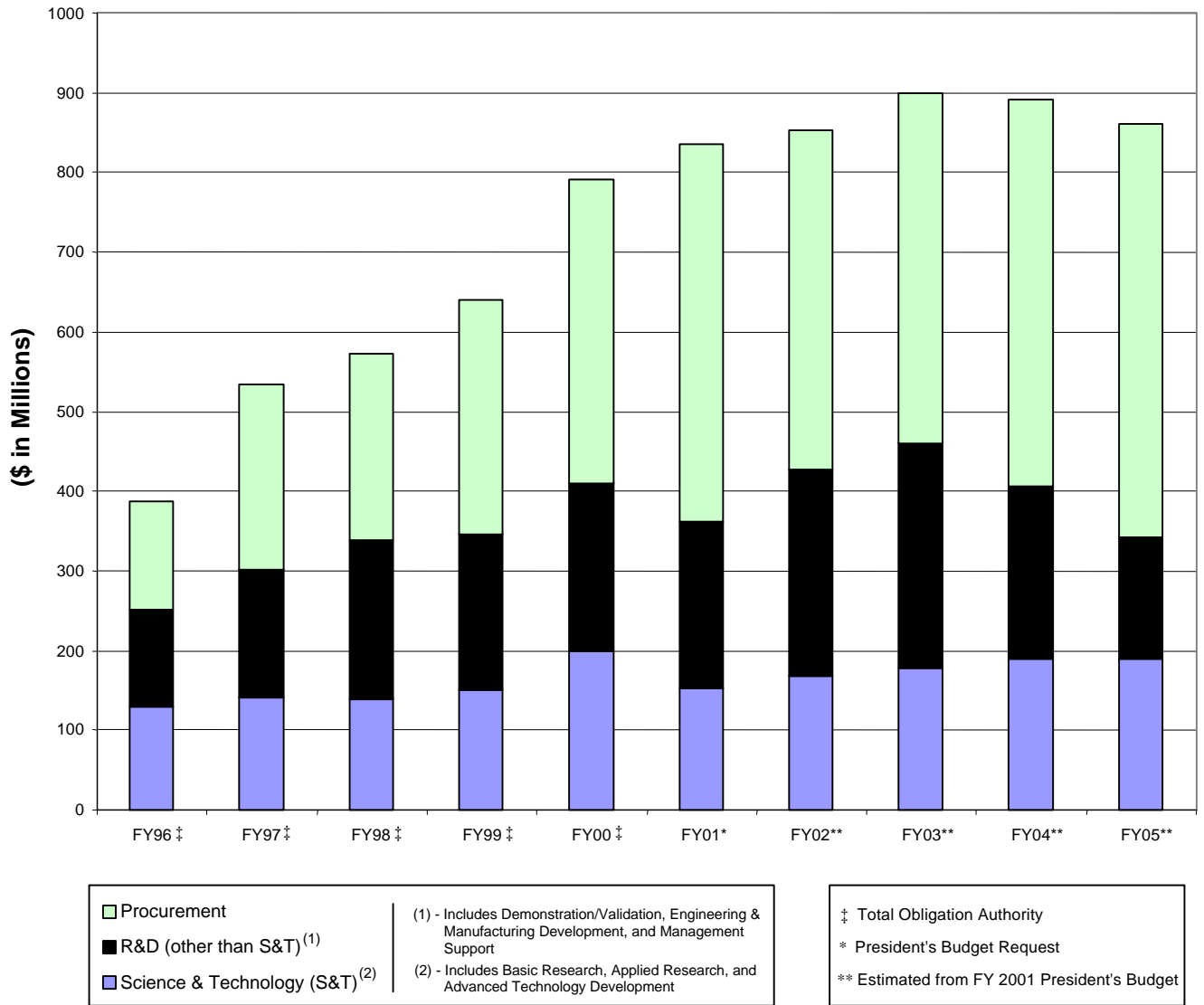

Figure E-1. Chemical and Biological Defense Program Appropriations Summary

(INTENTIONALLY BLANK.)

Annex F

Nuclear, Biological, and Chemical Defense Internet Sites

Following is a list of selected locations on the internet that may provide information about nuclear, biological, and chemical defenses. This list is not intended to be exhaustive, but rather to aid those in the research and analysis of NBC defense issues. Identification of a site here does not represent an endorsement by the Department of Defense nor any of its subordinate organizations, nor any responsibility for the content or accuracy of information provided at each site. Site locations (URLs) may change or be deleted, but were accurate as of January 3, 2000.

DefenseLink

<http://www.defenselink.mil/>

The official home page of the Department of Defense. Includes numerous reports and links to DoD organizations.

Defense Threat Reduction Agency

<http://www.dtra.mil>

Home page of the Defense Threat Reduction Agency). Includes information on each of the major mission areas and Directorates at DTRA.

CBIAC (Chemical Warfare/Chemical Biological Defense (CW/CBD) Information Analysis Center)

<http://www.cbiac.apgea.army.mil/>

CBIAC serves as the DoD focal point for CW/CBD technology. The CBIAC serves to collect, review, analyze, synthesize, appraise and summarize information pertaining to CW/CBD. It provides a searchable database for authorized users and links to many other CW/CBD related sites.

The NBC Medical Defense Information Server

<http://www.nbc-med.org/>

The Nuclear Biological and Chemical Medical (Med-NBC) web page contains extensive medical documentation, training material, audio-video clips, a powerful search engine, and links to other related internet sites.

The Army Medical Department Center and School

<http://www.armymedicine.army.mil/armymed/>

Provides extensive information about the Army's Medical Department. Includes information on doctrine development and the use of medical NBC defense products.

U.S. Army Soldier and Biological Chemical Command Information Server

<http://www.sbccom.apgea.army.mil/>

Home page of the U.S. Army Soldier and Biological Chemical Command.

Edgewood Chemical and Biological Center (ECBC) Home Page

<http://www.sbcom.apgea.army.mil/RDA/ecbc/>

ECBC is the Army's principal R&D center for chemical and biological defense technology, engineering, and service. Provides technical and other information on ECBCs products and services.

Joint Service Chemical Biological Information System (JSCBIS)

<http://www.sarda.army.mil/jscbis/jscbis.htm>

Provides financial and programmatic information for DoD's Chemical and Biological Defense Program. Requires user identification and password, which can be applied for through the home page.

Dugway Proving Ground Home Page

<http://www.atc.army.mil/~dugway/>

Home page of the U.S. Dugway Proving Ground, location of much of the field tests of chemical and biological defense equipment and repository of historical chemical and biological warfare information.

Chemical and Biological Weapons Nonproliferation Project

<http://www.stimson.org/cwc/>

This project serves as a problem-solver and an information clearinghouse in the general subject areas of CB treaties, chemical demilitarization (especially in Russia), CB terrorism, and related areas. Sponsored by The Stimson Center.

The PTS-OPCW-PrepCom Home Page

<http://www.opcw.nl/>

The home page of the Provisional Technical Secretariat, the Organization for the Prohibition of Chemical Weapons, and the Preparatory Commission of the Chemical Weapons Convention (CWC). Provides detailed information about the CWC, its implementation, and technical and background information on chemical weapons, chemical defenses, and related subjects.

United States Army Chemical School

<http://www.wood.army.mil/usacmls/>

Home Page for the US Army Chemical School at Fort Leonard Wood, MO. Provides information on the U.S. Army Chemical School which is one of the most advanced and sophisticated training centers for chemical and biological defense.

Harvard Sussex Program on CBW Armament and Arms Limitation

<http://fas-www.harvard.edu/~hsp/>

Provides files that promote the global elimination of chemical and biological weapons and to strengthen the constraints against hostile uses of biomedical technologies.

Medical Chemical and Biological Defense

<http://mrmc-www.army.mil/>

Provides information on Medical Chemical Defense Overview, Nerve, Agents, Cyanide, Skin Decontamination and Protection, Performance Effects of Protectant Drugs, and Chemical Casualty Management. Linked to the Medical Research and Materiel Command Home Page and the U.S. Army Medical Research Institute for Chemical Defense Home Page (<http://chemdef.apgea.army.mil>). Also provides information on Medical Biological Defense Overview, Diagnostic Assays, Viruses, Bacteria, and Toxins, Drugs, Vaccines, and Biological Casualty Management.

United States Army Medical Research Institute of Infectious Diseases

<http://www.usamriid.army.mil>

Home Page of the U.S. Army Medical Research Institute of Infectious Diseases, location of much of the science and technology research efforts for medical biological defense.

Armed Forces Radiobiological Research Institute (Medical Radiological Defense)

<http://www.afrrri.usuhs.mil/>

Provides information on Medical Radiobiological research and education activities of the triservice Armed Forces Radiobiological Research Institute. The site includes information on the latest developments, products, resources, research approach, strategy, research teams/staff, outreach training, professional meetings, and links to related sites.

Defense Advanced Research Projects Agency (DARPA)

<http://www.darpa.mil/>

Home Page of DARPA describes basic and applied research and development projects being performed for DoD, including biological warfare defense projects though link to the Defense Sciences Office (<http://www.darpa.mil/dso/>), the Microsystems Technology Office (<http://www.darpa.mil/mto/>), and the Special Projects Office (<http://www.darpa.mil/spo/>).

Program Manager for Chemical Demilitarization

<http://www-pmcd.apgea.army.mil/index.html>

Provides information on the Chemical Stockpile Disposal Program, the Non-Stockpile Chemical Materiel Program, the Alternative Technologies Program, the Chemical Stockpile Emergency Preparedness Program, and the Cooperative Threat Reduction Office.

Joint Vaccine Acquisition Program

<http://www.Armymedicine.army.mil/jvap>

Home page of the Joint Vaccine Acquisition Program Office, provides program history, programmatic information concerning the DoD efforts to produce vaccines against biological warfare agents

Joint Program Office for Biological Defense

<http://www.jpobd.net>

Home page of the Joint Program Office for Biological Defense. The site is currently being developed and will include information concerning the DoD biological defense acquisition programs managed by the Joint Program Manager for Biological Defense to include enhanced detection systems, Hand Held Immunochromatographic Assays (HHAs), the Joint Field Trials (JFTs), medical products and vaccines.

NBC Industry Group

<http://www.nbcindustrygroup.com/>

Home page of the NBC Industry Group, an association of organizations supporting NBC defense, domestic preparedness, and the Chemical Weapons Convention.

Anthrax Vaccine Immunization Program

<http://www.anthrax.osd.mil/>

Home page of the Department of Defense total force anthrax vaccine immunization program.

Office of the Special Assistant for Gulf War Illness

<http://www.gulflink.osd.mil/>

Official website of the Special Assistant for Gulf War Illness. The site provides information regarding the findings of the office on Gulf War Illness and links to related information.

Monterey Institute of International Studies, Center for Nonproliferation Studies

<http://cns.miis.edu/>

Website provides links to original research and resources in nonproliferation, chemical and biological terrorism, and specific regional nonproliferation regimes.

Annex G

Statement Regarding Chemical and Biological Defense Programs Involving Human Subjects

The reporting requirement (50 USC 1523) for the annual report to Congress on the DoD Chemical and Biological Defense Program was modified by Section 1086 of the FY98 National Defense Authorization Act. The amendment requires the following information:

A description of any program involving the testing of biological or chemical agents on human subjects that was carried out by the Department of Defense during the period covered by the report, together with a detailed justification for the testing, a detailed explanation of the purposes of the testing, the chemical or biological agents tested, and the Secretary's certification that informed consent to the testing was obtained from each human subject in advance of the testing on that subject.

Table F-1 provides a summary of prior and planned tests conducted by the Department of Defense, both directly or under contract, which involve the use of human subjects for the testing of chemical or biological agents. In summary, there has been no such testing since 1969 with biological agents, since 1975 for chemical agents, and no testing is planned.

**Table F-1. Summary of Experiments and Studies with Human Subjects
Involving the Use of Chemical or Biological Agents**

November 25, 1969	– Human biological agent testing ended
July 28, 1975	– Human chemical agent testing ended
Since 1969/1975	– No activities with human subjects involving exposure to biological agents (since 1969) nor chemical agents (since 1975) have occurred since testing ended

The Department is in full compliance with the requirements of all laws regarding the use of human subjects involving chemical or biological agents. DoD is involved in no experimentation or any other efforts which involve the exposure of human subjects to chemical or biological agents.

As part of the DoD Chemical and Biological Defense Program, DoD requires the use of small quantities of chemical and biological agents in the research, development, test and evaluation of detection, protection, and decontamination equipment and systems. Chemical and biological agents are also used in small quantities in training U.S. forces to operate in protective equipment and to operate detection and decontamination systems in a chemical or biological

environment. However, no research, development, test or evaluation involves the exposure of human subjects to chemical or biological agents.

Medical chemical and biological defense programs involve the use of human subjects in controlled clinical trials to test and evaluate the safety, immunogenicity, and other effects of medical products (drugs, vaccines, therapies, *etc.*) to protect against chemical and biological agents. The use of human subjects in these trials involves volunteers who have provided informed consent. All use of human subjects in these trials is in full compliance with the “Common Rule,” Federal Policy for the Protection of Human Subjects, Food and Drug Administration (FDA) regulations, Federal Acquisition Regulations (FAR), DoD Directives and Instructions, and *all* other applicable laws, regulations, issuances, and requirements. No medical chemical or biological defense programs involving human subjects involves the exposure of these subjects to chemical or biological agents.

While DoD conducted tests involving the exposure of human subjects to chemical and biological agents in the past, all such tests and programs have been halted and disbanded. The United States formally renounced the “use of lethal biological agents and weapons, and all other methods of biological warfare” in National Security Decision 35, November 25, 1969. Human testing with lethal biological warfare agents was never done and testing with incapacitating biological warfare agents was ceased in 1969. The last human testing of chemical warfare agents occurred on July 25, 1975. Acting Secretary of Army Norman Augustine suspended testing of chemical compounds on human volunteers on July 28, 1975.

Tests involving the exposure of human subjects to chemical agents began in the 1940s and continued following World War II through the Cold War until the early 1970s. Such testing has been documented and reported to Congress. See for example, Department of Army, Inspector General Report, DAIG-IN 21-75, *Use of Volunteers in Chemical Agent Research*, March 1976. In addition, there was extensive congressional testimony on this subject during 1975 and 1976. DoD has not conducted any experimentation since that time involving the exposure of human subjects to chemical warfare agents.

Annex H

Congressional Reporting Requirement: 50 USC 1523

<p>Text of Public Law Mandating Report on The Department of Defense Chemical and Biological Defense Program</p>
--

**Title 50 of the U.S. Code, Sec. 1523. Annual report on chemical and biological warfare defense
Implemented by Public Law 103-160, The FY94 National Defense Authorization Act**

(a) Report required

The Secretary of Defense shall include in the annual report of the Secretary under section 113(c) of title 10, a report on chemical and biological warfare defense. The report shall assess--

- (1) the overall readiness of the Armed Forces to fight in a chemical-biological warfare environment and shall describe steps taken and planned to be taken to improve such readiness; and
- (2) requirements for the chemical and biological warfare defense program, including requirements for training, detection, and protective equipment, for medical prophylaxis, and for treatment of casualties resulting from use of chemical or biological weapons.

(b) Matters to be included

The report shall include information on the following:

- (1) The quantities, characteristics, and capabilities of fielded chemical and biological defense equipment to meet wartime and peacetime requirements for support of the Armed Forces, including individual protective items.
- (2) The status of research and development programs, and acquisition programs, for required improvements in chemical and biological defense equipment and medical treatment, including an assessment of the ability of the Department of Defense and the industrial base to meet those requirements.
- (3) Measures taken to ensure the integration of requirements for chemical and biological defense equipment and material among the Armed Forces.
- (4) The status of nuclear, biological, and chemical (NBC) warfare defense training and readiness among the Armed Forces and measures being taken to include realistic nuclear, biological, and chemical warfare simulations in war games, battle simulations, and training exercises.
- (5) Measures taken to improve overall management and coordination of the chemical and biological defense program.
- (6) Problems encountered in the chemical and biological warfare defense program during the past year and recommended solutions to those problems for which additional resources or actions by the Congress are required.
- (7) A description of the chemical warfare defense preparations that have been and are being undertaken by the Department of Defense to address needs which may arise under article X of the Chemical Weapons Convention.
- (8) A summary of other preparations undertaken by the Department of Defense and the On-Site Inspection Agency to prepare for and to assist in the implementation of the convention, including activities such as training for inspectors, preparation of defense installations for inspections under the convention using the Defense Treaty Inspection

Readiness Program, provision of chemical weapons detection equipment, and assistance in the safe transportation, storage, and destruction of chemical weapons in other signatory nations to the convention.

(9) A description of any program involving the testing of biological or chemical agents on human subjects that was carried out by the Department of Defense during the period covered by the report, together with a detailed justification for the testing, a detailed explanation of the purposes of the testing, the chemical or biological agents tested, and the Secretary's certification that informed consent to the testing was obtained from each human subject in advance of the testing on that subject.

Annex I

Acronyms and Abbreviations

Note: The acronyms and abbreviations in this annex reflect an extensive, though not exhaustive, list of terms related to the various and diverse CB defense activities. This definitions are authoritative definition and may have different meanings in other contexts.

-A-

AAAV – Advanced Amphibious Assault Vehicle
AAR – after action report
AARS – Advanced Airborne Radiac System
ABO – Agent of Biological Origin
ACAA – Automatic Chemical Agent Alarm
ACADA - Automatic Chemical Agent Detector
ACC – Air Combat Command
ACES – Air Force Command Exercise System
Ach – acetylcholine
ACOM – Atlantic Command
ACPLA – agent containing particle per liter of air
ACPM – Aircrew Protective Mask
ACTD – Advanced Concept Technology Demonstration
ADS – Area Detection System
AERP – Aircrew Eye/Respiratory Protection
AFIP – Armed Forces Institute of Pathology
AFMAN – Air Force Manual
AFMS – Air Force Medical Service
AFRRI – Armed Forces Radiobiology Research Institute
AG – Australia Group
AICPS – Advanced Integrated Collective Protective System
AIDET – Aircraft Interior Detector
AIT – Aeromedical Isolation Team
ALAD – Automatic Liquid Agent Detector
ALSA – Air Land Sea Application
AMAD – Automatic Mustard Agent Detector
AMC – U.S. Army Materiel Command
AMEDDC&S – Army Medical Department Center and School
ANCOC – Advanced NCO Course
ANG – Air National Guard
AN/VDR-2 – Portable dose-rate gamma/beta radiation meter
AN/VDR-13 – Compact, digital whole body radiation meter
APODS – Aerial Port of Debarkation
ARNG – Army National Guard
ARTEP – Army Training and Exercise Plan
ASA(ALT) – Assistant Secretary of the Army for Acquisition, Logistics & Technology

ASBREM – Armed Services Biomedical Research Evaluation and Management
ASCC – Air Standardization Coordinating Committee
ASD(HA) – Assistant Secretary of Defense for Health Affairs
ASD(SO/LIC) – Assistant Secretary of Defense for Special Operations and Low-Intensity Conflict
ATD – Advanced Technology Demonstration
AT/FP – Antiterrorism Force Protection
ATG – Afloat Training Group
ATH – Air Transportable Hospital
ATP – Adenosine Triphosphate
ATSD(NCB) – Assistant to the Secretary of Defense for Nuclear and Chemical and Biological Defense Programs
ATSO – Ability to Survive and Operate
AVIB – Aircrew Uniform Integrated Battlefield
AVIP – Anthrax Vaccine Immunization Program

-B-

B. anthracis – *Bacillus anthracis* (anthrax)
B. mallei– *Burkholderia mallei* (glanders)
BBS – Brigade Battle Simulation
BCTP – Battle Command Training Center
BD – biological detector (also, biological defense)
BDO – Battledress Overgarment
BDU – Battledress Uniform
BES – Budget Estimate Submission
BG – *Bacillus Globigii*
BIDS – Biological Integrated Detection System
BL – Biosafety Level
BNCOC – Basic Non-Commissioned Officer Course
BOG – Board of Governors
BoNT – Botulinum Neurotoxin
BoNT/A – Botulinum Neurotoxin A
BoNT/B – Botulinum Neurotoxin B
BRP – Basic Research Plan
BTN – below the neck
BuChE – butyrylcholinesterase
BVO/GVO – black vinyl overboot/green vinyl overboot
BW – biological warfare
BWC – Biological Weapons Convention

BWD – Biological Warfare Defense

–C–

C⁴I – command, control, communication, computer, and intelligence

C. burnetii – *Coxiella burnetii* (Q fever)

CA – Commodity Area

CAA – Center for Army Analysis

CA/D – Chemical Activity/Depot

CaE – carboxylesterase

CAM – Chemical Agent Monitor (also, Commodity Area Manager)

CAMEX – Computer Assisted Map Exercise

CANA – Convulsant Antidote, Nerve Agent autoinjector

CANE – Combined Arms in a Nuclear/Chemical Environment

CAPDS – Chemical Agent Point Detection System

CARDS – Chemical Agent Remote Detection System

CASTFOREM – Combined Arms and Support Task Force Evaluation Model

CatOx – catalytic oxidation

CAWM – Chemical Agent Water Monitor

CB – chemical and biological (also C/B)

CBAT – Chemical Biological Augmentation Team

CBAWM – Chemical Biological Agent Water Monitor

CBD – chemical and biological defense

CBDP – Chemical/Biological Defense Program

CBIRF – Chemical Biological Incident Response Force

CBIS – CB Individual Sampler

CBM&S – Chemical/Biological Modeling & Simulation

CBMS – chemical biological mass spectrometer

CBNP – Chemical Biological Non-Proliferation

CBPS – Chemical Biological Protective Shelter

CBR – Chemical, Biological, and Radiological

CBR-D – Chemical, Biological, Radiological Defense

CBRNC – Chemical, Biological, Radiological & Nuclear Countermeasures

C/B-RRT – Chemical Biological Rapid Response Team

CBS – Corps Battle Simulation

CBSD – Chemical Biological Stand-off Detector

CBW – chemical and biological warfare

CCD – Camouflage, Concealment, and Deception

CDC – Centers for Disease Control and Prevention

CD-ROM – Compact Disk - Read Only Memory

CDTF – Chemical Defense Training Facility (at the U.S. Army Chemical School)

CEES – half mustard (2-chloroethyl ethylsulfide)

CEM – Concept Evaluation Model

CENTCOM – Central Command

CESM – Chemical Environment Survivability Mask

CESS – Chemical Environment Survivability Suit

CFD – Computational Fluid Dynamics

CFM – cubic feet per minute

CFR – Code of Federal Regulations

CHAMP – Chemically/biologically Hardened Air Management Plant

CHATH – Chemically/Biologically Hardened Air Transportable Hospital

ChE – Cholinesterase

CINC – Commander-in-Chief

CINCCENT – Commander-in-Chief Central Command

CINCPAC – Commander-in-Chief Pacific Command

CJCS – Chairman of the Joint Chief of Staff

CM – Chloroform-Methanol (also, consequence management)

CMO – Central MASINT Office

CMR – Chloroform-Methanol Residue

CMTC – Combat Maneuver Training Center

CNS – Central Nervous System

COBC – Chemical Officer Basic Course

COMMZ – Communications Zone

COMPTUEX – Composite Training Unit Exercise

CONOPS – Concept of Operations

CONUS – continental United States

COTS – Commercial Off-the-Shelf

CP – chemical protective (also, collective protection, or counterproliferation)

CPE – Collective Protection Equipment

CPO – Chemical Protective Overgarment

CPRC – Counterproliferation Review Council

CPS – Collective Protection System

CPU – Chemical Protective Undergarment

CRDA – Cooperative Research & Development Agreement

CRG – Compliance Review Group

CSST – Chemical Casualty Site Team

CT – Concentration over time

CTC – Combat Training Center

CTR – Cooperative Threat Reduction

CTS – Casualty Training System

CVC – Combat Vehicle Crewmen

CVIP – Chemical Vision Implementation Plan

CW – Chemical Warfare

CWA – Chemical Warfare Agent

CWC – Chemical Weapons Convention

CWCIWG – Chemical Weapons Convention Implementation Working Group

CWDD – Chemical Warfare Directional Detector (AN/KAS-1A)

CWICS – Chemical Weapons Interior Compartment System

-D-

DAB – Defense Acquisition Board
 DAP – Decontaminating Apparatus Portable
 DARPA – Defense Advanced Research Projects Agency
 DATSD (CBD) – Deputy Assistant to the Secretary of Defense for Chemical/Biological Defense
 DCSOPS – U.S. Army Deputy Chief of Staff for Operations
 DDR&E – Director, Defense Research and Engineering
 DEA – Data Exchange Agreement
 DEPMEDS – Deployable Medical Systems
 DEST – Domestic Emergency Response Team
 DLA – Defense Logistics Agency
 DMMP – Dimethyl Methyl Phosphonate
 DNA – Deoxyribonucleic Acid
 DNBI – Disease and Non-Battle Injury
 DoD – Department of Defense
 DoE – Department of Energy
 DPE – Demilitarization Protective Ensemble
 DPG – Defense Planning Guidance; Also Dugway Proving Grounds
 DRB – Defense Review Board (also, Defense Resources Board, or Division Ready Brigade)
 DRI – Defense Reform Initiative
 DS2 – Decontamination Solution 2
 DSCP – Defense Supply Center Philadelphia
 DSO – Defense Sciences Office
 DTO – Defense Technology Objective
 DTAP – Defense Technology Area Plan
 DTRIP – Defense Technical Inspection Readiness Program
 DTLOMS – Doctrine, Training, Leader Development, Organization, Material, and Soldier/Personnel
 DTO – Defense Technology Objective
 DT/OT – developmental/operational testing
 DTRA – Defense Threat Reduction Agency
 DTRA(CB) – Defense Threat Reduction Agency’s Chemical and Biological Defense Directorate

-E-

E. coli – *Escherichia coli*
 ECBC – Edgewood Chemical & Biological Center
 ECV – Expanded Capacity Vehicle
 ED – ethyl dichlorarsine
 EEE – Eastern Equine Encephalomyelitis
 EEG – electroencephalographic
 ELISA – Enzyme-Linked Immunosorbent Assay
 EMD – Engineering and Manufacturing Development
 ENCOMPASS – Enhanced Consequence Management Planning and Support System
 EOD – Explosive Ordnance Disposal

EUCOM – European Command

-F-

F1 – Fraction 1
 F1-V – Fraction 1 - “V” Antigen
 Fab – Fragment Antigen Binding
 FAR – Federal Acquisition Regulations
 Fc – Fragment Crystallizable
 FCBC – Field Management of Chemical and Biological Casualties Course
 FDA – Food and Drug Administration
 FDTE – Force Development Testing and Experimentation
 FEST – Foreign Emergency Response Team
 FLEETEX – Fleet Exercise
 FM – Field Manual
 FORCEM – Force Evaluation Model
 FR – flame resistance
 FUE – First Unit Equipped
 FY – fiscal year
 FY99 – Fiscal Year 1999
 FYDP – Future Years Defense Plan

-G-

GA – tabun, a nerve agent
 GAO – General Accounting Office
 GB – sarin, a nerve agent
 GC – gas chromatography
 GD – soman, a nerve agent
 GF – a nerve agent
 GMP – Good Manufacturing Practice
 GPFU – Gas Particulate Filter Unit
 GPRA – Government Performance and Results Act

-H-

HAZWARN – NBC Hazardous Warning System
 HAZWOPR – Hazardous Waste Operations and Emergency Response
 hBuChE – Human Butrylcholinesterase
 hCaE – Human Carboxylesterase
 HD – sulfur mustard, a blister agent
 HEPA – high efficiency particulate
 HHA – Hand Held Immunochromatographic Assays
 HMMWV – High Mobility Multipurpose Wheeled Vehicle
 HN – Host Nation
 HSC/YA – Human Systems Program Office
 HTA – high threat area

-I-

IBAD – Interim Biological Agent Detector
 IBMC – Industrial Base Maintenance Contract
 ICAD – Individual Chemical Agent Detector
 ICAM – Improved Chemical Agent Detector

ICDS – Improved Chemical Detection System
IDLH – Immediate Danger to Life and Health
IEG – Information Exchange Group
IET – Initial Entry Training
IL – Interleukin
IL CBDWS – In-Line Chemical Biological Defense Water System
IM – intramuscular
IMS – Ion Mobility Spectroscopy
IND – Investigational New Drug
IP – intraperitoneal
IPDS – Improved (chemical) Point Detection System
IPE – Individual Protective Equipment
IPT – Integrated Product Team
IR&D – Independent Research & Development
IR-LIDAR – Infrared Light Detection and Ranging
IS – Instrumentation System
ISD – Individual Soldier Detector
ITAP – Improved Toxicological Agent Protective Ensemble
ITS – Individual Training Standard
IVD – Individual Vapor Detector

–J–

JAWG – Joint Assessment Working Group
JBPDSS – Joint Biological Point Detection System
JBREWS – Joint Biological Remote Early Warning System
JBSDS – Joint Biological Standoff Detection System
JBUD – Joint Biological Universal Detector
JCAD – Joint Chemical Agent Detector
JCBAWM – Joint Chemical Biological Agent Water Monitor
JCBUD – Joint Chemical and Biological Universal Detector
JCHEMRATES – Joint Chemical Defense Equipment Consumption Rates
JCPE – Joint Collective Protection Equipment
JCRS – Joint Canteen Refill System
JCS – Joint Chiefs of Staff
JFIRE – Joint CB Protective Firefighter Suit
JFOC – Joint Future Operational Capabilities
JFT – Joint Field Trail
JLAS – Joint Land, Aerospace, and Sea Simulation
JMAR – Joint Medical Asset Repository
JMCDRPP – Joint Medical Chemical and Biological Defense Research Program
JMCDRPP – Joint Medical Chemical Defense Research Program
JMNS – Joint Mission Need Statement
JMRR – Joint Monthly Readiness Review
JNBCDB – Joint NBC Defense Board

JORD – Joint Operational Requirements Document
JPACE – Joint Protective Aircrew Ensemble
JPO-BD – Joint Program Office for Biological Defense
JRCAB – Joint Readiness Clinical Advisory Board
JRTC – Joint Readiness Training Center
JSA – Joint Service Agreement
JSAM – Joint Service Aviation Mask
JSCBIS – Joint Service Chemical Biological Information System
JSGPM – Joint Service General Purpose Mask
JSIG – Joint Service Integration Group
JSIMS – Joint Simulation System
JSLIST – Joint Service Lightweight Integrated Technology (individual protection)
JSLNBCRS – Joint Service Light NBC Reconnaissance System
JSLSCAD – Joint Service Lightweight Stand-off Chemical Agent Detector
JSMG – Joint Service Materiel Group
JSMLT – Joint Service Mask Leakage Tester
JSNBCRS – Joint Service NBC Reconnaissance System
JSTPCBD – Joint Science and Technology Panel for Chemical/Biological Defense
JSWILD – Joint Service Warning and Identification LIDAR Detector
JTASC – Joint Training and Analysis Center
JTAV – Joint Total Asset Visibility
JTC – Joint Training Council
JTCG – Joint Technology Coordinating Group
JTCOPS – Joint Transportable Collective Protection System
JTF – Joint Task Force
JTPCBD – Joint Technology Panel for Chemical and Biological Defense
JVAP – Joint Vaccine Acquisition Program
JWARN – Joint Warning and Reporting Network
JWFC – Joint Warfighting Center
JWSTP – Joint Warfighting S & T Plan

–L–

L – lewisite, a vesicant agent
LAM – Louisiana Maneuvers
LCBPG – Lightweight CB Protective Garment
LD₅₀ – Median Lethal Dose
LDS – Lightweight Decontamination System
LHA – general purpose amphibious assault ship
LHD – general purpose amphibious assault ship (with internal dock)
LIDAR – Light Detection And Ranging
LLC – limited liability corporation
LLR – Low Level Radiological
LMS – Lightweight Multipurpose Shelter
LNBCRS – Light NBC Reconnaissance System

LRBSDS – Long-Range Biological Stand-off
Detection System
LSCAD – Lightweight Stand-off Chemical Agent
Detector
LSCD – Laser Stand-off Chemical Detector
LSD – landing ship, dock
LSP – Logistics Support Plan
LWRS – Lightweight Reconnaissance System

–M–

M&S – Modeling and Simulation
M&S CA – Modeling and Simulation commodity
Area
M&S R&D – Modeling and Simulation Research
and Development
MAGTF – Marine Air Ground Task Force
MAJCOM – Major Command
MALDI – Matrix-Assisted Laser Desorption
Ionization
MANAA – Medical Aerosolized Nerve Agent
Antidote
MANSCEN – Maneuver Support Center
MANTECH – Manufacturing Technology
MASINT – Measures & Signatures Intelligence
MBDRP – Medical Biological Defense Research
Program
MCBAT – Medical Chem-Bio Advisory Team
MCBC – Management of Chemical and Biological
Casualties Course
MCPE – Modular Collective Protection System
MCU-2A/P – a chemical protective mask
MCWP – Marine Corps Warfighting Publication
MD – methyl dichlorarsine
MDS – Modular Decontamination System
MED – Medical
MEIR – Medical Effects of Ionizing Radiation
METL – Mission Essential Task List
metL, thrA – methionine biosynthesis
MEU – Marine Expeditionary Unit
MFR – Multi-Function Radiac Set
MICAD – Multipurpose Integrated Chemical Agent
Detector
MIL STD – Military Standard
MLRS – Multiple Launch Rocket System
MNDRP – Medical Nuclear Defense Research
Program
MNS – Mission Needs Statement
MOE – Measure of Effectiveness
MOP – Memorandum of Policy
MOPP – Mission Oriented Protective Posture
MOS – Military Occupational Specialist
MOU – Memorandum of Understanding
MPH – miles per hour
MPS – Mission Performance Standard (also,
Multipurpose Protective Sock)

MPSP – Medical Program Sub-Panel
MRMC – Medical Research and Materiel
Command
MS – Mass Spectrometry
MTW – Major Theater War
MULO – Multi-purpose Overboot
murE – murein biosynthesis

–N–

NAADS – Nerve Agent Antidote Delivery System
NAAG – NATO Army Armaments Group
NAAK – Nerve Agent Antidote Kit
NAAS – Nerve Agent Antidote System
NAPP – Nerve Agent Pyridostigmine Pretreatment
NATO – North Atlantic Treaty Organization
NBC – Nuclear, Biological, and Chemical
NBCDT – NBC Defense Training
NBC-E – nuclear, biological, and chemical-
environment
NBCRS – NBC Reconnaissance System (Fox
Vehicle)
NBCWP – NBC Defense Interservice Working
Party
NCO – Non-Commissioned Officer
NDA – New Drug Application
NDI – Non-Developmental Item
NEPMU – Navy Environmental and Preventative
Medicine Unit
NFPA – National Fire Protection Agency
NGIC – National Ground Intelligence Center
NICP – National Inventory Control Points
NIEX – No-Notice Interoperability Exercise
NIH – National Institute of Health
NO – nitric oxide
NSN – National Stock Number
NTA – Novel Threat Agent
NTC – National Training Center
NWP – Naval Warfare Publication

–O–

OAC – Officer Advance Course
OBC – Officer Basic Course
OG – Overgarment
O&M – Operations & Maintenance
OPCW – Organization for the Prohibition of
Chemical Weapons (in The Hague)
OPR – Office of Primary Responsibility
ORD – Operational Requirements Document
OSD – Office of the Secretary of Defense
OSM3 – oximeter instrument
OTSG – Office of the Surgeon General

–P–

P3I – Pre-Planned Program Improvement
PACAF – Pacific Command

PACOM – Pacific Command
PAM – Preventative and Aerospace Medicine
PATS – Protective Assessment Test System
PB – President’s Budget
PCPS – Portable Collective Protection System
PCR – polymerase chain reaction
PD – phenyl dichlorarsine
PDDA – Power Driven Decontamination Apparatus
PDM – Program Decision Memorandum
PDRR – Program Definition and Risk Reduction
PE – Program Element
PF – Positive Force Exercise
PICS – Personal Ice Cooling System
PIP – Product Improvement Program
PL 103-160 – Public Law 103-160, The National
Defense Authorization Act of FY94
PMCD – Program Manager for Chemical
Demilitarization
PMO – Product Management Office
POL – petroleum, oil, and lubricant
POM – Program Objectives Memorandum
PQS – Personnel Qualification
PR – Positive Response Exercise
PRG – Program Review Group
PROFIS – Medical NBC Professional Filler Course
PSA – Pressure Swing Adsorption

–Q–

QDR – Quadrennial Review
QNFT – Quantitative fit testing
QRR – Qualitative Research Requirements
QSTAG – Quadripartite Standardization Agreement
QWG – Quadripartite Working Group

–R–

RBC-AchE – red blood cell acetylcholinesterase
R&D – Research and Development
RDA – Research, Development, and Acquisition
RDTE (Also, RDT&E) – Research, Development,
Test and Evaluation
RestOps – Restoration of Operations
RMC – Regional Medical Commands
RSCAAL – Remote Sensing Chemical Agent Alarm
RSTA – Reconnaissance, Surveillance, and Target
Acquisition
RTP – Readiness Training Plan
rTSP – Reactive Topical Skin Protectant
RW – radiological/nuclear warfare

–S–

S&T – Science & Technology Base
SACPS – Selected Area Collective Protection
System
SAF – Semi-Automated Forces

SAFEGUARD – Scanning Airborne Fourier
Emission for Gaseous Ultraspectral Analysis
and Radiometric Detection
SAG – Study Advisory Group
SALAD – Shipboard Automatic Liquid Agent
Detector
Saratoga – a CB protective overgarment
SAT – Systems Approach to Training
SAW – Surface Acoustic Wave
SBA – Simulation Based Acquisition
SBCCOM – Solider, Biological and Chemical
Command (U.S. Army)
SCALP – Suit Contamination Avoidance Liquid
Protection
SCAMP – Shipboard Chemical Agent Monitor
Portable
SCPE – Simplified Collective Protective Equipment
SCUD – surface-to-surface missile system
SD – Stand-off Detector
SD/ASM – Stand-off Detector for Armor System
Modernization
SDK – Skin Decontamination Kit
SDS – Sorbent Decon System
SE – staphylococcal enterotoxins
SEA – Staphylococcal Enterotoxin A
SEB – Staphylococcal Enterotoxin B
SGXA – Air Force Surgeon General
SMART-CB – Special Medical Augmentation
Response Team-Chemical./Biological
SMART-PM – Special Medical Augmentation
Response Team-Preventative Medicine
SNCO – Staff-Noncommissioned Officer
SOF – Special Operations Forces
SOFCAS – Special Operation Forces Chemical
Agent Detector
SOI – School of Infantry
SO/LIC – Special Operations and Low Intensity
Conflict
SOMCBD – Special Operations Modular CB
Detector
SORTS – Status of Resources and Training System
SPOD – Seaport of Debarkation
SRT – Specialty Response Team
S&T – Science & Technology
STANAG – standard agreement
STB – Supertropical Bleach
STEPO – Self-Contained Toxic Environment
Protective Outfit
STEPO-I – Interim Self-Contained Toxic
Environment Protective Outfit
STO – Science and Technology Objective
STRAC – Standards in Training Commission
STS – Specialty Training Standard

-T-

TAA – Total Army Analysis
TACWAR – Tactical Warfare
TAP – Toxicological Agent Protective boots and gloves
TARA – Technology Area Review and Assessment
TAV – Total Asset Visibility
TB – Technical Bulletin
TBM – Transportation of Biomedical Materials
TDA – table of distribution and allowances
TED – Troop Equivalent Dose
TEMPER – Tent Extendable Modular Personnel
TEU – Technical Escort Unit
TIC – Toxic Industrial Chemical
TIM – toxic industrial material
TSA – Transition State Analogue
TSG – The Surgeon General
TSP – Topical Skin Protectant
TSWG – Technical Support Working Group

-U-

UAV – Unmanned Aerial Vehicle
UDP – Unit Deployment Program
UN – United Nations
UNSCOM – United Nations Special Commission
USA – United States Army
USACHPPM – United States Army Center for Health Promotion and Preventive Medicine
USACMLS – US Army Chemical School
USAF – United States Air Force
USAMEDDC&S – U.S. Army Medical Department Center and School
USAMMA – U.S. Army Medical Materiel Agency
USAMMDA – U.S. Army Medical Materiel Development Activity
USAMRICD – U.S. Army Medical Research Institute of Chemical Defense
USAMRIID – U.S. Army Medical Research Institute of Infectious Diseases
USAMRMC – U.S. Army Medical Research and Materiel Command

USANCA – United States Army Nuclear and Chemical Agency
USAR – US Army Reserve
USC – United States Code
USD(A&T) – Undersecretary of Defense (Acquisition and Technology)
USFK – U. S. Forces, Korea
USG – United States Government
USMC – United States Marines Corps
USN – United States Navy
USUHS – Uniformed Services University of the Health Sciences
UTC – Unit Type Code

-V-

VCA – Voice Communication Adapter
VCSA – Vice Chief-of-Staff of the Army
VEE – Venezuelan equine encephalomyelitis
VIC – Vector-In-Command
VIG – Vaccinia Immune Globulin
VLSTRACK – Vapor, Liquid, and Solid Tracking Model
VPU – Vapor Protective Undergarment
VTC – Video Teleconference
V&V – verification and validation
VVS – Vehicles, Vans and Shelters
VX – a nerve agent

-W-

WCF – Working Capital Fund
WEE – Western Equine Encephalomyelitis
WG – Working Group
WMD – weapons of mass destruction
WRAIR – Walter Reed Army Institute of Research
WRM – war reserve materiel
WRSI – War Reserves Secondary Items

-Y-

Y. pestis – *Yersinia Pestis* (Plague)

(INTENTIONALLY BLANK.)