

THIS FILE IS MADE AVAILABLE THROUGH THE DECLASSIFICATION EFFORTS AND RESEARCH OF:

THE BLACK VAULT

THE BLACK VAULT IS THE LARGEST ONLINE FREEDOM OF INFORMATION ACT / GOVERNMENT RECORD CLEARING HOUSE IN THE WORLD. THE RESEARCH EFFORTS HERE ARE RESPONSIBLE FOR THE DECLASSIFICATION OF THOUSANDS OF DOCUMENTS THROUGHOUT THE U.S. GOVERNMENT, AND ALL CAN BE DOWNLOADED BY VISITING:

[HTTP://WWW.BLACKVAULT.COM](http://www.blackvault.com)

YOU ARE ENCOURAGED TO FORWARD THIS DOCUMENT TO YOUR FRIENDS, BUT PLEASE KEEP THIS IDENTIFYING IMAGE AT THE TOP OF THE .PDF SO OTHERS CAN DOWNLOAD MORE!

FMFRP 12-42

Professional Knowledge Gained from Operational Experience in Vietnam, 1968



U.S. Marine Corps

PCN 140 124200 00

DEPARTMENT OF THE NAVY
Headquarters United States Marine Corps
Washington, DC 20380-0001

12 July 1989

FOREWORD

1. PURPOSE

Fleet Marine Force Reference Publication (FMFRP) 12-42, *Professional Knowledge Gained from Operational Experience in Vietnam, 1968*, is published to ensure the retention and dissemination of useful information which is not intended to become doctrine or to be published in Fleet Marine Force manuals. FMFRPs in the 12 Series are a special category of publications: reprints of historical works which were published commercially or by the U.S. Government Printing Office and are no longer in print.

2. SCOPE

This reference publication complements existing training manuals on small-unit tactics, patrolling, weapons, mines and boobytraps, and leadership. Written by a multitude of Marines during the Vietnam War, this volume is an excellent compendium of lessons to be learned from the Marine Corps' experience in 1968. It is enthusiastically recommended to all junior officers, SNCOs, and NCOs who will profit from the principles presented.

3. CERTIFICATION

Reviewed and approved this date.

BY DIRECTION OF THE COMMANDANT OF THE MARINE CORPS



M. P. SULLIVAN

Major General, U.S. Marine Corps
Deputy Commander for Warfighting
Marine Corps Combat Development Command
Quantico, Virginia

DISTRIBUTION: "T L 8"

TABLE OF CONTENTS

<u>Chapter</u>	<u>Page</u>
I MARINES IN VIETNAM - 1968 SUMMARY	
Introduction	1
Special Landing Force Operations . . .	8
Air Operations	9
Combined Action Program	9
Kit Carson Scout Program	10
Revolutionary Development and Pacification	12
Accelerated Pacification (Le Loi) Campaign	15
II TACTICS	
Section 1 - FRIENDLY	
Standing Orders, Rogers Rangers . . .	17
Operation Definitions for Marines . . .	19
Rules of Engagement	22
Security and Press Relations	28
Attack of Fortified Positions in the Jungle	30
Employment of Boat Teams in Con- junction with Sweep Operations . . .	40
Use of OP's in Conjunction with Road Sweeps	41
Employment of the 60mm Mortar on Road Sweeps	42
Employment of Recon/Ambush Teams to Observe River Crossing Sites . .	42
Minesweeping Techniques	44
No Place for the Curious	44

<u>Chapter</u>	<u>Page</u>
II Section 1 - FRIENDLY (Continued)	
Formations for Cross-Country	
Movement	45
Flank Security	46
Crossing Bridges Where Enemy	
Strength is Unknown	47
Bridge Security	47
Combat in Built-up Areas (Operation	
Hue City)	48
Movement in Built-up Areas	48
90mm Concrete-Piercing Rounds.	50
Seating Base Plate of 60mm Mortar	
During Monsoon Season	50
Supporting Arms Fire Request	51
Countermortar Fire	53
Jungle Navigation	53
Water for Long-Range Patrols	57
Patrol Tips	57
Ambush Safety Technique	58
Troop Comments/Tips.	59
Road Reconnaissance.	60
A Picture is Worth a Thousand	
Words	61
Kit Carson Scouts	62
Stream Crossing.	63
Tank River Forging.	64
Herbicide Operations.	64
Monsoon Season Operational	
Planning.	66
Incountry Training	69

Chapter

Page

Section 2 - ENEMY

Enemy Tactics - DMZ Area	71
NVA Ambush Tactics.	73
Use of Civilians by Enemy to Mask Ambushes	77
Enemy Mine Warfare.	78
Enemy Probes and Mining Activity. . .	80
Mines and Explosive Devices Em- ployed by the VC/NVA.	81
VC Mine Indicators	95

III AVIATION

Air-to-Air Refueling	101
Angle of Attack Circuit Breaker on Center Aft Console (AGA Aircraft).	103
AMTI Missions.	104
Turn and Slip Circuit Breaker, Aft Center, A-6A Aircraft.	106
Flight Control Failure Following Loss of Hydraulic Pressure in F-8E Series Aircraft	106
Zuni Launchers F8 Aircraft	107
Fuel Dump Valve Operation in the A-4E Aircraft	109
Danger - Jet Blasts.	110
Helicopter Conservation.	110
Helicopter Ground Fire	111
Helicopter Damage Caused by Radio Antennas.	112

III AVIATION (Continued)

Helicopter Note, Ground Resonance . . .	113
Damage to Artillery Weapons Caused by Improper Rigging for External Carry by Helicopters	114
Improper Loading of the CH-53A Helicopter.	115
External Transportation of Cargo Utilizing the Nylon Four Point Universal Sling	116
Employment of CH-53 to Emplace M4T6 Bridges	117
Enemy Action During Tactical Air- craft Recovery.	118
Turbine Engine Limitations	118
Monsoon Tips--Rotary Wing.	119
Use of UH-1E "SLICK" for Extractions/Medevac Missions . . .	120
Night Extraction of Reconnaissance Patrols.	121
Use of Smoke Flares During Emergency Night Extractions	122
Helicopter Landing Zones.	122
Clearance of Landing Zones	123
Maintaining Helicopter LZ's	124
Landing Zone Lighting During Night or Reduced Visibility	124
Enemy "Baiting" Aircraft to Land in Ambush Area.	125

<u>Chapter</u>	<u>Page</u>
----------------	-------------

III AVIATION (Continued)

Employment of the AN/TPQ-10 Ground Radar with Automatic Mode of the Ground Control Bomb System (GCBS).	126
Survival Equipment in SV-2 Vest.	127
Colored Personnel Parachute Canopy.	128
Midair Collision Causes.	129
Maintenance and the Aircraft Accident Rate	130
Aerial Photograph Requests	131
Eyes in the Sky.	132

IV COMMUNICATIONS

LVT Communications	135
HF/SSB Equipment	136
Ultrahigh Frequency (UHF) Antenna AS-390/SRC.	137
FM Antenna Alignment.	138
Field Expedient Antenna.	139
Increase Vehicular Radio Range	140
Maintenance of Comm/Elect Equipment.	140
Preventive Maintenance of the Antenna Elements AT-1095 and AT-1096/AN/MRC-109	141
Radio Set AN/MRC-83	142
Radio Set AN/TRC-75	142
AN-PRC-49C Emergency Radios	143

IV COMMUNICATIONS (Continued)

Protect Helmet Radio Cords	144
Extend Equipment Life.	145
Radio Handsets.	145
Handset H-138	146
Cable Bracket for Use on Concrete Power Poles	147
Overhead Cable with Field Wire WD 1/PT	148
Remoting Radios Over Long Distance Utilizing AN/PRC-25, AN/TRC-27/B and AN/GRA-39 Radio Equipments.	150
Remoting the AN/PRC-25 with the AN/GRA-39.	151
Field Expedient Five-Drop Switchboard.	152
Switchboard Soundproofing	153

V LOGISTICS

Wheeled Vehicles	155
Tailgating	156
Multifuel Vehicle Operating Tips	157
Two and One-half Ton Multifuel Truck Clutch Rod.	158
Fuel Lines on the M-54 Truck.	159
Starter Switches	160
Wrecker Operations	161
Deadly Carbon Monoxide	161

V LOGISTICS (Continued)

Tips for Diesel Fuel Users	163
Towing the M-151 Jeep	163
M-151 Hints	164
Protection for the Main Cable From the Xenon Light to the Gun Turret	166
M48A3 Tank	167
M48A3 Cupola Jamming	168
Towcable for Tank Section	168
M-110 Gas Check Pads	169
For Lack of a	169
Fire Control Equipment PM's	170
Metascope PM's	173
Trailers	174
Air Cleaners Require Daily Inspection	174
Hydraulic Failures on the Tractor, TD-15	175
Generators	176
Battery Care	177
Field Expedient Rifle Cleaning Rod	178
Drain Before Shooting	179
AK-47 Assault Rifle	180
Headspace and Timing, MG Cal..50	182
Proper Care and Handling of Ammunition	184
Ammunition Storage in SVN	187
Class V(A) Reporting	187
Dud Munitions	188
Safe Handling of Fuels	189

<u>Chapter</u>	<u>Page</u>
V LOGISTICS (Continued)	
Loading Plans	190
Shiploading	190
Water Purification Units and Related 55 GPM Pumps	191
Device for Filling Disposable Water Containers	192
Proper Handling of Secondary Reparable Items.	193
VI PACIFICATION AND PSYOPS	
Definitions of Terms	195
Background	196
Successful Civic Action Techniques . .	217
Viewpoints From Personal Response .	221
Results Are as Important as Motives .	223
The Chieu Hoi Program	224
Chieu Hoi Intelligence Source	225
Chieu Hoi Leaflets	226
Exploitation of VC Vulnerabilities . . .	227
Leaflet Distribution.	234
VII MEDICAL	
The Corpsman and the Unit One.	237
Artificial Respiration.	239
Heat Casualties	240
Personal Cleanliness Tips	241
Malaria Control	243

<u>Chapter</u>	<u>Page</u>
VII MEDICAL (Continued)	
Superficial Wounds	243
Extra Battle Dressings	244
Medical Tip	244
Ambulance Readiness Tips	245
Medevac Procedures	246
Positioning of Medevac Helicopters in an Unsecured Zone	249
Patrol Medevac Planning	250
Robertson Litter	250
Dental Treatment	252
Dental Field Units	253

Chapter I: MARINES IN VIETNAM - 1968 SUMMARY

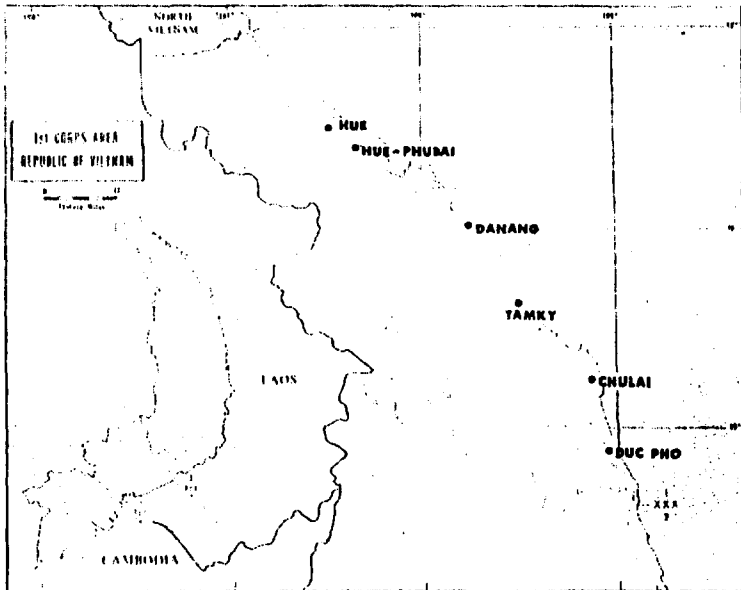

1. INTRODUCTION

In early 1968, for the first time in the Vietnamese struggle, the enemy committed his main force to sustained, decisive combat throughout South Vietnam. Targeting large population centers, as yet untouched by the war, the enemy executed a well coordinated massive offensive during the Tet holiday in early February. Gambling on the hope that the populace would join against the GVN if supported by the presence of NVA/VC forces, the enemy directed his operations in three main efforts:

- Attack Allied installations to tie down units and divert counteroffensive efforts.

- ① Attack province, city, and district government headquarters to destroy GVN control.

- ② Invade and hold large population centers, liquidate key Vietnamese officials and citizens, and organize the people against the GVN.

In the I CTZ, large enemy formations made determined attacks against Dong Ha, Quang Tri City, Hue City, Danang, and Hoi An. On the western flank of the DMZ, Khe Sahn began its trial. III MAF forces met the enemy Tet offensive with a full response. In Hue City, Marines fought a stubborn enemy, house to house. Other Marines and Allied troops maneuvered against and engaged NVA/VC forces, who held their ground until defeated in detail. But the enemy effort, though well coordinated and stubbornly fought, was based on a false premise. The Vietnamese people did not desert the GVN. Instead, the people actively resisted the invaders and drew closer to the government.

At the beginning of the enemy Tet offensive, many ARVN units were at minimum manning strength. Troop commanders, in accordance with the agreed Tet cease-fire, had granted leaves so that soldiers could be with their families during the Christmas-like holiday. When the full force of the enemy attack hit, the GVN forces recoiled, quickly rallied, and counterattacked. Troops on leave made their way back to their units or joined other organizations in the fight.



III MAF and GVN forces repulsed the enemy Tet offensive in the ICTZ, inflicting a loss on the enemy equivalent to ten divisions. (More than 100,000 NVA/VC were killed or captured, or defected by the end of operations.) The Armed Forces of Vietnam, faced with their toughest trial, responded in all five provinces with a thoroughly professional performance. The government, also faced with its most serious test, reacted with strength, moving energetically to restore order, repair damage, and renew the advance of pacification and revolutionary development.

The faulty evaluation of the sympathies of the people of South Vietnam was not the only error committed by the enemy. In executing the Tet

offensive, the VC infrastructure in objective areas was forced to surface, exposing it to elimination. In addition, routes, assembly areas, and base camps were exposed; and valuable caches of supplies and equipment were completely expended or captured by maneuvering Allied forces. But most serious was the loss of enemy manpower. Enemy casualties were more than statistics. These were first class troops: mainforce VC units, elite, long protected from exposure to sustained decisive combat; and disciplined formations from the north, well trained and dedicated. The quality could not be replaced.

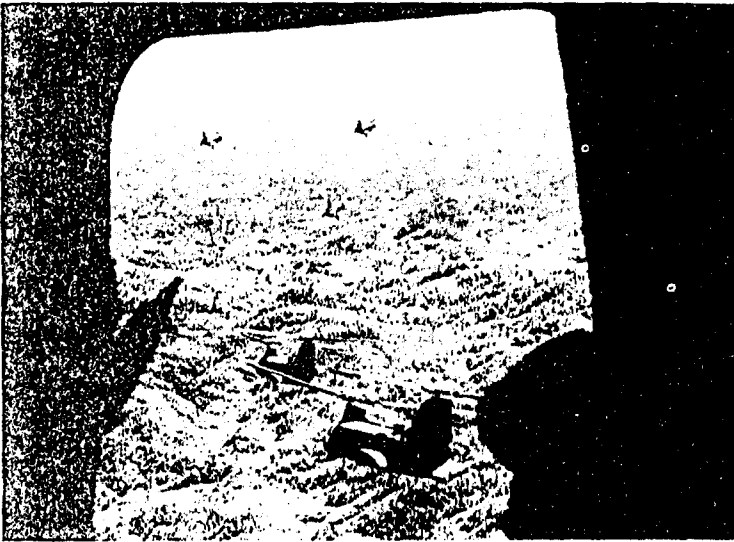

While remnant enemy forces fought rearguard actions, Marines of III MAF, reinforced by two U.S. Army divisions, turned the pursuit into a major offensive, relieving enemy pressure against Khe Sahn and striking at uncovered enemy base areas.

Driving deep into the canopled mountains, friendly forces pushed NVA/VC units from long established base areas, forcing them to abandon valuable supplies and equipment. But even more critical to the enemy than the loss of material brought down from the north, was the disruption of lines of communications to the coast. The enemy depended on the rice rich coastal regions for his food supply. Driven away from this source, he was forced to expend operational energy to obtain rice. An unremitting counterguerrilla and rice denial campaign in the coastal regions further complicated enemy efforts. The significant increase in the number of defectors complaining of starvation rations was proof of the situation.

Early in the summer, the detection of a major enemy buildup south of Danang shifted major combat efforts from the northern to the central area of the I CTZ. Until the end of the year, wide ranging major operations, characterized by rapid night movements of major Marine units and swift helicopterborne assaults, continued to frustrate enemy designs on Hoi An and Danang.

Thwarted by wide ranging major operations, the enemy further lost ground during the year to an obstructive buffer of small unit efforts protecting areas of pacification and military vital areas. The 208,000 III MAF patrols, ambushes, and company-size sweep operations inflicted a loss of 8,100 NVA/VC troops on the enemy.



GVN forces continued to demonstrate a marked improvement in the application of combat skills. Following their successful combat performance during Tet, the ARVN retained their aggressive spirit, accounting for 26,688 enemy killed by year-end. (This is more than double the 12,483 NVA/VC credited to the ARVN in 1967.) Having demonstrated the ability to match enemy combat power, the ARVN assumed an increased responsibility in both the prosecution of the war and development of GVN influence throughout the I CTZ.

Even while the enemy Tet offensive was still being fought, the GVN began a meaningful civil recovery program to lay the framework for a sound pacification effort. The 1 November commencement of the Accelerated Pacification Campaign climaxed



this year of substantive advance. By the end of 1968 the campaign was well underway. 1968 results included a record 3,118 Hoi Chanh, more than 4,000 Viet Cong infrastructure cadre neutralized, 69% of the ICTZ population considered secure, and nearly a quarter-million civilians organized in the People's Self-Defense Organization.

With support of Revolutionary Development and Pacification at its core, the III MAF program of counter guerrilla and large unit operations, together with its flexible and responsive logistic and air efforts, achieved substantial progress toward the objectives of defeating the VC/NVA forces and assisting expansion of GVN control.

#

2. SPECIAL LANDING FORCE OPERATIONS

The SEVENTH Fleet Special Landing Forces (SLF) executed 13 amphibious operations during 1968, a total substantially smaller than the 25 conducted in 1967. The dynamic situation existing in northern I CTZ during early 1968 required deployment of both SLF Alfa and Bravo in the DMZ area during January; both remained there under operational control of III MAF until summer. Highlighting the actions of the SLF's during this extended period ashore was the participation of their two Marine BLT's in Operations KENTUCKY, LANCASTER, and NAPOLEON/SALINE. For example, Operation NAPOLEON/SALINE, initially launched as an amphibious assault to clear the Cua Viet area, accounted for nearly 3,500 NVA/VC killed in 1968, of which the majority were credited to SLF elements.

With the diminishing of overall enemy combat capability in I CTZ, both SLF's were back-loaded aboard amphibious shipping, thereby providing a mobile striking force of proven strength for quick employment against located enemy targets. The value of this unique amphibious capability as an instrument of the Accelerated Pacification Campaign was amply demonstrated during November and December. Employed either as an integral element of a force established ashore, such as in Operation MEADE RIVER south of Danang, or as a separate tactical entity, as in DARING ENDEAVOR and VALIANT HUNT, both south of Hoi An, the SLF

has proven singularly adept at establishing a rapid, undetected cordon of a target area. Illustrating the success of such operations, VALIANT HUNT in December accounted for the elimination of 43 hard core Viet Cong infrastructure (VCI).

#

3. AIR OPERATIONS

Paralleling the accelerated pace of ground combat activity, Marine fixed wing and helicopter air support reached record levels during 1968. Pilots of the 1st Marine Aircraft Wing flew 92,385 fixed wing sorties in and out-of-country during the year - a 16% increase over the 79,532 flown in 1967. Helicopter pilots of the wing and the two Special Landing Forces realized an even greater increase, flying 670,995 sorties in 1968, 31% more than the 510,595 flown in 1967.

#

4. COMBINED ACTION PROGRAM

The Combined Action Program (CAP), a Marine-initiated program for upgrading the tactical proficiency of Vietnamese territorial forces, has expanded consistently since the first platoon was organized in Phu Bai during the summer of 1965. By 1 January 1968, there were 79 combined action platoons in I CTZ, and through the year, 23 more were activated. In April, the program developed



mobile training teams (MTT's), which have provided two weeks of basic combat instruction to more than 70 I Corps Popular Force platoons.

During its 3½ years, the Combined Action Program not only has expanded physically, but has evolved a workable solution for the problem of an undeveloped territorial security force. Everyday association with Marines has enhanced greatly the ability and confidence of Popular Force soldiers participating in the program.

#

5. KIT CARSON SCOUT PROGRAM

By December 1968, 476 former Viet Cong soldiers were being employed in combat operations



by the four III MAF divisions and the four combined action groups.

Success of Scout-accompanied patrols, and the daring, tenacious nature exhibited by Kit Carson Scouts, was highlighted in December by incidents involving Ding Van MINH, who is assigned to 1st Battalion, 26th Marines. On the evening of 5

December, MINH, accompanying a Company D patrol, recommended an ambush site to the patrol leader after observing signs of recent enemy movement. Later, as an NVA column approached the squad, MINH fired the initiating claymore mine, killing five NVA only a few feet from his position. Although wounded as he exposed himself to enemy fire, he threw grenades into the remaining enemy and, on one occasion, returned an enemy-thrown grenade. MINH again demonstrated his resourcefulness against the enemy late in December; kidnapped by eight armed guerrillas on the 15th, he escaped and returned to his unit on 28 December.

#

6. REVOLUTIONARY DEVELOPMENT AND PACIFICATION

As 1968 began, the pacification program in I CTZ had attained substantial results, with more than 50% of the region's 3.1 million civilians living in secure hamlets. The government, effectively implementing its revolutionary development campaign, was advancing the erosion of the enemy's oft-claimed popular support, and the enemy reacted violently, launching his massive Tet offensive of late January and early February.

This offensive, contrived to generate dramatic popular uprisings and disrupt the political, economic, and military functions of the GVN, was, in



the main, unsuccessful. The U.S. and GVN claims of progress in their pacification efforts were vindicated, however, as the Vietnamese citizenry rallied, not around the National Liberation Front, but behind their duly-elected government. Death and destruction among the civilian population, particularly in Hue, were the only tangible products the enemy achieved, with more than 6,400 civilians killed or wounded, over 54,000 structures destroyed or damaged, and some 155,000 Vietnamese rendered temporarily homeless.

Executing his offensive during Tet, the enemy gained the element of surprise, as Vietnamese government and military forces were understrength as a result of personnel on leave for the celebration of the traditionally peaceful lunar new year holiday. After the initial shock, however, GVN machinery gradually began to regenerate power, and

organization of a comprehensive recovery program during the first week in February signaled the start of a coordinated GVN/U.S. effort to provide timely and protracted relief to the civilian population. Between its inception in February and its mid-October termination, this program, entitled Operation RECOVERY, spent in excess of \$500,000 in reestablishing normalcy to the lives of victimized civilians in I CTZ. Examples of other assistance provided were:

- resettlement of more than 152,000 (98%) of the offensive's temporary refugees;

- provision of more than 131,000 bags of cement and over 276,000 sheets of roofing tin for the reconstruction of homes;

- supplying nearly 50,000 tons of rice and grain to supplement the diet of families displaced by the battles;

- inoculation of some 500,000 civilians against contagious diseases.

The enemy, defeated militarily by rapidly reacting III MAF and ARVN units and thwarted psychologically by timely assistance provided civilians through the GVN, recoiled from the Tet offensive with his long-sought major victory yet unwon. Twice again during the year, however, the enemy attempted to launch widespread offensives, but each time--in May and in August--his effort ended in abortive

disaster. On 1 November, with recovery complete and the enemy surges blunted, the GVN initiated a special pacification effort.

#

7. ACCELERATED PACIFICATION (LE LOI) CAMPAIGN

The Accelerated Pacification (LE LOI) Campaign is a GVN organized, U.S. supported offensive scheduled to restore, by 31 January 1969, pre-Tet security levels to those hamlets yet afflicted from the enemy's three 1968 offensive attempts and to lend added momentum to the 1968 Revolutionary Development Program. During the LE LOI Campaign, high priority was attached to attaining the best possible GVN security posture prior to the advent of Tet in February 1969. And, as an added benefit, the program provided initial momentum for the 1969 GVN Pacification and Reconstruction Plan.

Chapter II: TACTICS

Section 1 - FRIENDLY



1. STANDING ORDERS, ROGERS RANGERS

In 1759 Major Robert Rogers issued the following Standing Orders to his detachment of American Rangers who were engaged in the French and Indian War. Although written over 200 years ago, the lessons learned then are applicable now.

- Don't forget nothing.
- Have your musket clean as a whistle, and be ready to march at minute's warning.

→ Tell the truth about what you see and what you do. There is an Army depending on us for correct information.

→ When we camp, half the party stays awake while the other half sleeps.

→ If we take prisoners, we keep'em separate til we have had time to examine them, so they can't cook up a story between 'em.

→ Don't ever march home the same way. Take a different route so you won't be ambushed.

→ No matter where we travel, each party has to keep a scout 20 yards ahead, 20 yards on each flank and 20 yards in the rear, so the main body can't be surprised and wiped out.

→ Don't sit down to eat without posting sentries.

→ Don't sleep beyond dawn. Dawn's when the French and Indians attack.

→ If somebody's trailing you, make a circle, come back onto your own tracks, and ambush the folks that aim to ambush you.

→ Let the enemy come til he's almost close enough to touch. Then let him have it and jump out and finish him up with your hatchet.

#

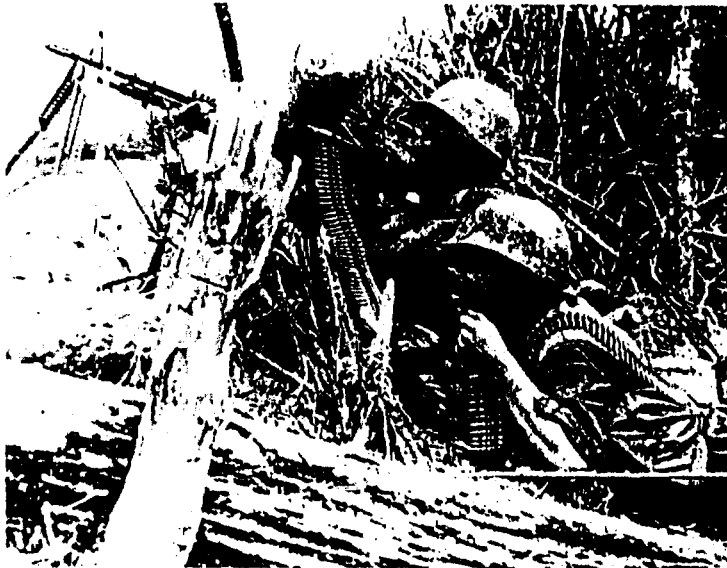

2. OPERATION DEFINITIONS FOR MARINES

The variety of operations that a unit or Marine will participate in during a normal tour are numerous and varied as to the primary mission and the projected results. To alleviate some of the possible confusion, the following definitions are applicable to Marines throughout the I Corps Tactical Zone:

→ Major Unit Operation. An operation that will last 24 hours or longer with a task organization of at least a battalion command group and three rifle companies.

→ Small Unit Operation. An operation which does not satisfy the criteria for a major unit operation. A major objective of small unit operations

within the TAOR's is to deny the VC freedom of movement and security provided by nighttime hours.

→ Cordon and Search Operation. A cordon and search operation is a combined military/civil operation with a threefold objective--fix and destroy the NVA/VC forces, screen out and neutralize the communist infrastructure, and bring the population under GVN control.

→ Special Operations. Those operations conducted for a specialized purpose such as route clearing, rice harvest protection, and border surveillance.

→ Surveillance/Strike Operations. Operations involving establishment of offensive outposts to maintain surveillance of an area not controlled by friendly forces and to engage VC/NVA targets of opportunity with supporting arms.

→ Clearing Operations. Operations conducted to clear an area of main force VC/NVA units in order to eliminate the immediate threat of overt enemy interference with Revolutionary Development actions that are to follow.

→ Securing Operations. Joint military and civil operations conducted in a cleared area for the purpose of establishing an area under permanent government control, free from Communist influence.

→ Static Security Operations. Those operations conducted to provide security for sensitive civil or military installations.

→ Rough Rider. The program designed to restore main and secondary road nets to GVN control. The concept provides for a special task organized force traversing main and secondary roads to demonstrate our intentions to use and open existing roads. The force transits the roads at random dates and times.

→ County Fair. The County Fair operation is a coordinated series or combination of military, governmental, civic action, and psychological warfare operations simultaneously concentrated on a specific hamlet/village complex for the purpose of eliminating the VC infrastructure and extending GVN control over the locale.

#



3. RULES OF ENGAGEMENT

In no other war has the requirement for specific rules of engagement been more necessary than in Vietnam. The war in Vietnam is a political as well as a military war. It is political because the ultimate goal is to regain the loyalty and cooperation of the people, and to create conditions which permit the people to go about their normal lives in peace and security. At the present time, a number of geographical areas in South Vietnam are completely controlled by the Viet Cong. In others, the people live under the shadow of VC military forces and terrorists. Because of this situation, the application of U.S. military force in Vietnam and the actions of U.S. troops must be carefully controlled at all times. On the one hand, maximum effectiveness must be achieved in operations against the VC; on the other hand, a conscientious effort must be made to minimize battle casualties among non-combatants and prevent destruction of their property. This requires an exceptionally high caliber of leadership plus the exercise of good judgment and unusual restraint. The following constitute the current rules of engagement for all III MAF commands. The exceptions to these rules, governing operations near SVN boundaries, are covered in separate directives.

→ MINIMIZING NONCOMBATANT BATTLE CASUALTIES: The Government of Vietnam is engaged in a fight for its survival against the Communist NVA/VC. It is the objective of the NVA/VC



to seize control of the hamlets, villages and towns by a combination of military actions, terrorism, political action and subversion. The Government of Vietnam is resisting this process and where it has occurred, is attempting to reverse it. This means that the battle flows backward and forward across the homes and fields of the rice farmer and small town inhabitant.

In order to reduce to a minimum the casualties inflicted on the noncombatant populace during the course of fighting in and around friendly civilian areas, commanders should ensure that the following actions are accomplished:

- Conduct a thorough and continuing program to emphasize the importance of minimizing noncombatant casualties.

- Exercise extreme caution in employing supporting arms near areas where noncombatants are located.

- Plan operations in coordination with province and district chiefs with due regard to security of plans.

- Configure specific strike zones to exclude populated areas except those in known VC bases.

→ INDIVIDUAL RESPONSIBILITY: The nature of the war has placed an unusual requirement on small unit leaders to carry out sensitive combat operations in an environment where large numbers of civilians are often present. The history of warfare embraces many examples of the proper and improper use of force in dealing with both noncombatants and prisoners of war. Determination of right and wrong in these cases has had to be made

on the spot and often in the heat of battle. Such decisions require a swift and decisive analysis of the factors involved and must be based on a thorough understanding of the legal and moral principles involved. The weight of this decision often falls on the shoulders of an individual who, because of his relative youth and short time in service, is least able to exercise deliberate judgment under the pressure of combat. Nevertheless, unit leaders, regardless of rank, must be fully aware of their responsibilities, their conduct, and the conduct of their subordinates.

→ CONTROL, DISPOSITION AND SAFEGUARDING OF VIETNAMESE PROPERTY AND FOOD SUPPLIES: In carrying out cordon and search operations in VC-controlled areas, Marines must take all practical measures to minimize the destruction of indigenous private property and to ensure proper control, disposition and safeguarding thereof. That people have lived under VC control does not make them irrevocably hostile nor is it necessarily of their own choosing. To treat them as the enemy and deny them essential resources is incompatible with long-term GVN and U.S. objectives.

Minimizing destruction of private property and supplies, coupled with proper control and disposition of excesses, requires continual command emphasis. Plans must include procedures for the protection of private property and the reporting, securing, and disposition of excess supplies.

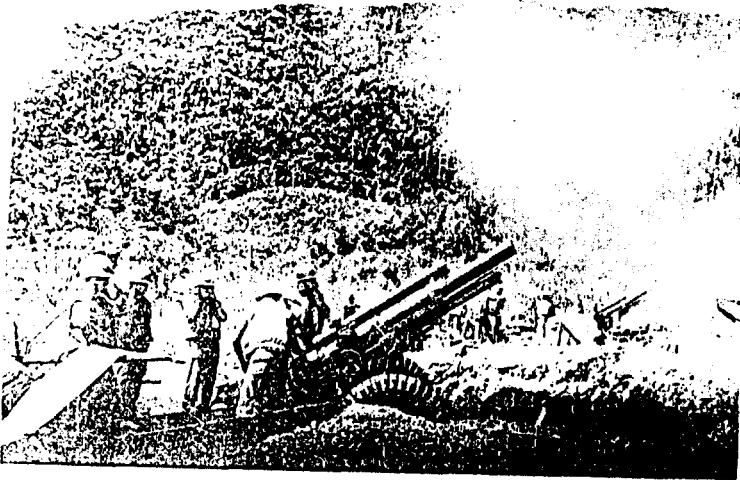

→ CONDUCT OF ARTILLERY/MORTAR AND NAVAL GUNFIRE MISSIONS: The nature of the battle area in Vietnam, and the frequent combined operations involving U.S. and SVN forces, require that special emphasis be placed on procedures for the control of artillery and naval gunfire. Restrictive controls should be held to the minimum but should ensure that;

- Friendly forces and civilians are not endangered.
- Property of friendly forces and civilians is not destroyed or damaged.
- National and operational boundaries are not violated.

Care and attention must be exercised continuously in the application of all artillery gunnery techniques. The full range of artillery gunnery techniques which ensure accuracy should be applied to the maximum extent permitted by the situation. The application of these techniques and the exercise of sound judgment on the part of all personnel involved in solving the artillery problem provide the best assurance against endangering friendly forces and civilians or destroying or damaging SVN, friendly forces and friendly civilians' property.

→ EMPLOYMENT OF RIOT CONTROL AGENTS (RCA): The enemy frequently intermingles with noncombatants. The use of RCA is a particularly appropriate application of measured force in such situations. The agents have been proven useful in many tactical operations such as clearance of fortified positions and underground facilities, reconnaissance for concealed forces, capture of prisoners for intelligence purposes, preparation of landing zones and the defense of fixed positions.

→ ECONOMIC WARFARE: Intelligence estimates indicate that there are certain basic items which are essential to the VC that we can effectively deny to them: money, foodstuffs, salt and medicines. Economic warfare measures are designed both to separate the Viet Cong from their sources of supply and to disrupt distribution of supplies they already have on hand.

#

4. SECURITY AND PRESS RELATIONS

Since a great deal of the combat action takes place in I CTZ, one will most likely have an opportunity to meet and talk with a variety of visitors including newsmen, U.S. and foreign dignitaries, and entertainers. Each Marine must understand that in addition to normal security considerations, policy and national interests are invariably involved with events in Vietnam. Talking with visitors is encouraged; however, good judgment and common sense should be used. If you are asked for your opinion on a particular matter, be sincere and truthful in your answer. Stick to the facts. Avoid rumor and exaggeration, and don't let your personal likes and dislikes influence the objectivity of your answers. Remember that anything you say concerning certain sensitive subjects may, at the least, cause embarrassment and misunderstanding, or worse, may endanger your life or the lives of your friends by jeopardizing our security. If you are asked questions which involve classified information, explain why they cannot be answered. You will probably find that deciding what to say about operations is your biggest difficulty. Nothing that could help the enemy should be discussed--for example, plans or locations of landing zones. If you are in doubt as to what should be discussed, consult your commanding officer. It isn't easy to weigh every word but with one comment useful to the enemy you may do more damage to the Marine Corps than all your years of faithful service can make up.

The following are some of the specific "DON'TS" which are dictated by security requirements:

- Don't discuss known friendly or enemy locations.
- Don't discuss unit movements.
- Don't discuss future operations, plans or orders.
- Don't discuss casualty information.
- Don't discuss status of supplies or personnel.

#



5. ATTACK OF FORTIFIED POSITIONS IN THE JUNGLE

The major U.S. commands within South Vietnam, including III MAF, conducted a seminar during January 1968 to discuss the enemy use of fortified positions in the jungle and to analyze the tactics and techniques employed by FVMAF in attacking these positions.

It was determined that the major problem has always been the location of the enemy in his fortified positions and base camps. The search for the enemy must proceed in a slow and deliberate manner to ensure that the lead element detects the position before the main body comes into direct contact. Once the enemy has been located, all available firepower and force is employed to "root out" the entrenched NVA or VC. The attack and reduction of the position is methodical, one bunker at a time.

Planning: Planning should be continuous, centralized, and in great detail. The plan should be thorough, simple, and disseminated to the extent that each rifleman fully understands the mission of his unit, how it is to be accomplished and his role in its accomplishment.

Know Your Enemy: Many problems can be avoided if a detailed study is made of the tactics and techniques of the enemy forces operating in a specific area. Data should be collected and evaluated to determine what the enemy can be expected to do.

Construction of Enemy Base Camps and Fortified Areas:

- Local inhabitants are used to construct tunnels and fortifications.
- Bunkers are constructed from locally available materials.
- Positions are interconnecting and mutually supporting.
- Firing apertures are small, located close to the ground, and extremely hard to see.
- Fire lanes are cleared of brush and growth up to 18 inches high and are difficult to detect.
- In some areas, particularly in I CTZ, the fortifications are directional in nature.
- Camouflage is exceptional; in most instances, bunkers cannot be detected until the unit is fired upon.
- Bunkers are built with a very low silhouette that blends into the natural growth of the area.
- Trench lines are constructed in depth; tunnels connect these trench lines and provide safe and

easy access to the numerous bunkers and fortifications.



Detection of Tunnels or Base Camps: An effective method of locating tunnels or base camps is to study the area of interest, searching for the following indicators:

- Movement of VC in a specific direction after being spotted by aircraft or patrols.
 - Sniper fire from an area with no easily located routes of ingress or egress.
 - Vegetable gardens in an uninhabited area.
- Once the area of search has been narrowed, aerial photography should be taken of suspect locations on a recurring basis and studied by imagery interpreters. This can be followed by interrogation of

local populace, Chieu Hoi's, and returnees who have occupied or helped in digging the tunnel system.

Employment of Scout Dogs: Scout dogs can be effectively employed to follow suspected Viet Cong who are detected moving into a suspect area. Scout dog teams must be accompanied by a friendly unit for protection.

Enemy Techniques and Tactics: The enemy permits the friendly force to penetrate his position, seals the opening, and destroys the force trapped inside.

- ➔ With the connecting tunnels and trenches, the enemy can move his forces and bring pressure to bear in any location.
- ➔ Bypassed bunkers may be reoccupied, if not destroyed by the attacking unit.
- ➔ NVA units will outflank the attacking force, probe and find the weak point, and attack the flanks and rear of the unit.
- ➔ Boobytraps and antipersonnel mines are placed on all avenues of approach, in anthills, mounds, dikes, trees, or other places which may afford protection to the attacker.



Friendly Techniques of Attacking a Fortified Position:

- ➔ Movement should be deliberate and cautious.
- ➔ Find the enemy position with the smallest element possible.
- ➔ Use all available fire support elements to clear out camouflage and boobytraps, and destroy fortifications.
- ➔ Adjust supporting fires in close to the attacking force.
- ➔ Keep artillery and mortar forward observers well forward to ensure supporting fires are being effectively and accurately used.

- Attack in a methodical manner to destroy one bunker at a time.
- Shift supporting fires to block an exposed flank and deny the enemy the ability to envelop the attacking force or to reinforce his positions.
- Use recoilless rifles or 3.5" rocket fire to destroy the bunkers and fortifications.
- Do not bypass bunkers; have supporting engineers destroy each bunker as it is overrun, or occupy it until it can be destroyed.
- Carry protective masks to permit employment of CS.
- Forcing the enemy out of bunkers by using white phosphorus grenades.
- Avoid advancing in the open; use cover and concealment provided by hedgerows, dikes, and tree lines.

Use of Supporting Artillery:

- Artillery fires should be massed whenever the target requires such treatment, if it is possible. This may not result in total destruction of the fortifications, but will greatly reduce the camouflage and concealment, while eliminating most of the boobytraps and antipersonnel mines.
- Artillery fire plans should be detailed and coordinated with close air support. These fires should complement each other.

→ Blocking fires should be used to force the enemy to remain in his positions or to interdict his routes of withdrawal.

→ Naval gunfire should be included in the fire support plan if available.

*



→ Delay fuzing will allow penetration of jungle canopy and increase probability of rounds having effect on the target.

Tactical Air Support:

→ Pilots should be sent to ground units to develop a better understanding of the ground commander's problems.

→ Aircraft ordnance normally requires a direct hit to destroy bunkers and fortifications. Delay-fuzed GP bombs are most effective in this role. Napalm is effective in clearing away camouflage, concealment, and boobytraps.

→ The pilot should endeavor to locate the target visually before engaging it. This affords the pilot a better opportunity to hit the target.

Use of Engineers: Engineers can be effectively employed by closely following the attacking force and destroying bunkers, filling in trenches, constructing landing zones for medevac and resupply, and policing the battle area. Dozers are particularly well-suited for covering up and destroying fortifications and bunkers.

Use of Tanks and APC's in Support of Attacks on Fortified Positions:

→ If the terrain and vegetation will permit, tanks and APC's can be employed effectively in attacks on fortified positions.



- The canister round from the main armament of the tank will clear away camouflage and expose the enemy fortifications. HE, fuze delay, will penetrate the position and kill the enemy inside; HE, superquick fuze, can be used to open the sides of the bunker.

- A dozer tank provides the capability to destroy the bunker and fill in the trench system as the attacking force moves through the position.

- Employment of tanks will reduce the effects of antipersonnel mines and boobytraps.

- APC's provide cover from small arms fire and protection against grenade fragments.

→ The machineguns of the APC's can be used effectively to support and to provide covering fire for assault teams.

→ Flamethrower tanks or APC's should be used when possible. These weapons are effective as psychological weapons as well as for their killing effect.

Training Emphasis: Training must be conducted in the use of special equipment and tactics used to attack a fortified position. The training should include the use of flamethrowers, satchel charges, LAW and other special devices used in this type of operation.

Requirements for Improved Capability to Conduct Attacks on Fortified Positions:

→ Munitions or devices to clear landing zones rapidly.

→ Marking device to penetrate jungle canopy.

→ Improved capability for aerial photography that will detect fortified positions in the jungle.

→ Devices for detection of the enemy tunnels and fortifications.

→ Destruction devices which are easily transported and capable of rapidly destroying tunnel complexes.

Fundamental Principles: The fundamental principles as presented in the various publications and manuals are sound. Correct application of these principles normally results in success on the part of the FWMAF. When ignored or not applied correctly, friendly casualties increased and the enemy was able to withdraw to fight another day.

#



6. EMPLOYMENT OF BOAT TEAMS IN CONJUNCTION WITH SWEEP OPERATIONS

Sweep operations are frequently conducted in areas partially bounded by rivers in order to reduce the size of the blocking forces and to take advantage of natural obstacles. However, rivers often

have heavy vegetation and dense undergrowth along the banks which provide excellent hiding places for the enemy. To afford better observation of vegetated riverbanks, one unit employed a team of riflemen in a 15-foot multipurpose barge with a 15-HP outboard motor to sweep the riverbanks while ground forces conducted sweep operations parallel to the river. By viewing the bank from two different angles, the chances of the enemy to successfully hide were greatly reduced. On another occasion, boat teams detected and killed two VC attempting to hide in the underbrush along the riverbank.

When conducting sweep operations in areas bounded by a waterway, consider the use of waterborne troops to search riverbanks visually and/or physically to enhance the speed and degree of success of such operations.

#

7. USE OF OP'S IN CONJUNCTION WITH ROAD SWEEPS

Experience in sweeping and clearing roads suspected of being mined has demonstrated the need for effective security between the time the road has been swept and the time vehicles begin to use the road. One effective method of preventing the enemy from emplacing a mine after the sweep team

passes is to utilize a scout-sniper team on commanding terrain from which the road can be observed. The team should be placed in position prior to the commencement of the road sweep and should remain until after traffic begins to flow.

#

8. EMPLOYMENT OF THE 60MM MORTAR ON ROAD SWEEPS

An immediately responsive indirect fire capability for road sweep teams can be provided by emplacing a 60mm mortar in the bed of a 6x6 truck. Sandbags should be placed in the bed of the truck to steady the mortar and to absorb the shock. The mortar provides added firepower in the event of an ambush and can be used for reconnaissance by fire on dangerous or suspicious areas before moving through them.

#

9. EMPLOYMENT OF RECON/AMBUSH TEAMS TO OBSERVE RIVER CROSSING SITES

The enemy utilizes many different crossing points to move troops and supplies across major waterways. Aerial observation is only partially effective in detecting these movements because the enemy can easily hide when an observation aircraft



approaches. Deployment of clandestine recon/ambush teams to areas from which likely river crossing sites can be observed is an effective method of denying crossing sites to the enemy.

#

10. MINESWEEPING TECHNIQUES

Command-detonated mines and explosive devices are most readily detected by the wires leading away from the shoulders of the road. Inasmuch as the areas adjacent to the road are, in many instances, rice paddies, the wires are often difficult or impossible to detect. Utilization of a pole-hook device has noticeably increased the capability for detecting these wires. The pole with a hook at the end is pulled through the water along the edges of the rice paddy, thus uncovering any wires which might be below the surface of the water. Also, the flank security which accompanies the sweep team should vary its disposition, route, and pattern every day so that the enemy cannot accurately predict the position of the security and emplace command-detonated mines for maximum effect.

#

11. NO PLACE FOR THE CURIOUS

During an operation, an LVT supporting a combat patrol struck a mine. Marines from the LVT and the patrol immediately began examining the damaged vehicle. While the troops were clustered around the LVT, an explosive device was command detonated by the enemy. The resulting explosion caused severe personnel casualties.

Any area in which known or suspected enemy explosive devices may be located should be cleared of all except those personnel who are specifically

required to locate and dispose of the devices. The enemy frequently utilizes mines and explosive devices in series. When one enemy device is detonated, only a minimum number of personnel are required for assistance and to conduct a search for additional devices. Areas in which explosive devices have been detonated are no place for the curious.

#

12. FORMATIONS FOR CROSS-COUNTRY MOVEMENT

To effectively conduct search and destroy operations and make maximum contact with the enemy on the ground of your choosing, cross-country movement through thick terrain is often necessary. Marine units have a tendency to move in a single column formation which, of course, narrows the terrain actually searched and improperly disposes the unit for battle. In order to cope with meeting engagements and retain the capability to immediately maneuver to the enemy's flanks and rear, movement in multiple column formations is more desirable. This method enables the unit to effectively cover the search area, cope with meeting engagements, have the capability to immediately maneuver to the enemy's flanks and rear, and provide flank security to the main body. When employing a multiple column formation, ensure that positive control is constantly maintained and that

each maneuvering column knows the exact location of the other maneuvering columns.

#

13. FLANK SECURITY

The VC/NVA employ reconnaissance teams along the route of advance of friendly units. These



enemy recon teams determine the direction the Marine units are traveling, locate bivouac sites, and provide information to their headquarters on Marine strength and mission. To eliminate these shadowing units, battalions have found that the use of flanking forces of up to company-size strength at a distance of 2000 or more meters is very effective. As an example, while a battalion operating near the DMZ was engaged in the destruction of enemy fortifications, a flanking company engaged and eliminated an enemy observation post that had established itself on a small hill overlooking the battalion's area of operation. This is proof, once again, that flank security is critical from the squad level up to the largest maneuver element in the field.

#

14. CROSSING BRIDGES WHERE ENEMY STRENGTH IS UNKNOWN

When crossing on foot, both sides of the bridge and the surrounding area should be covered by supporting arms. Spider holes and bunkers at ground level should be expected at the ends of the bridge. Quick aggressive movement by fire teams is the best method of crossing.

#

15. BRIDGE SECURITY

Many of the bridges that have been destroyed by the VC have been blown by satchel charges attached to the bridge pilings below the waterline. To

guard against this, divers are frequently used to check pilings for possible demolitions. A unique method of underwater illumination using flares has proven effective. A hand illumination flare (Signal Illuminating, Ground, White Star Parachute M127A1) fired straight down into the water next to the piling will ignite in approximately 5 1/2 seconds and will start to rise slowly to the surface, enabling the observer to check the piling for demolitions.

#

16. COMBAT IN BUILT-UP AREAS (OPERATION HUE CITY)

In house-to-house fighting, the enemy usually covers all building entrances and exits with automatic weapons and small arms fire. By employing the 106mm recoilless rifle and 3.5" rocket launcher to breach walls and sides of buildings, normal entrances and exits covered by enemy fire may be avoided.

#

17. MOVEMENT IN BUILT-UP AREAS

Fire and maneuver during street and house-to-house fighting must be precisely executed due to the confined battle area. Some considerations of primary importance are listed below:

→ Crossing streets in team rushes rather than individual rushes is very effective.



→ Efficient house-to-house movement on the fire team level is essential.

→ Entrance to rooms and buildings must be preceded by a thrown grenade, necessitating an ample supply of grenades.

→ The reserve platoon or company headquarters can best be utilized to secure a medevac site to preclude assault units being diverted for this task.

→ In a building of two or more stories, the ground level affords the best overhead protection from mortar fire; however, units which take cover in the ground floor during a mortar attack should return to the upper floors as soon as possible as the best observation and fields of fire are achieved from those levels.

#

18. 90MM CONCRETE-PIERCING ROUNDS

The tank concrete-piercing fuze (CP), assembled with an HE round has proven highly effective in destroying enemy bunkers. The most effective method of employment is to use CP fuzed rounds on initial volleys to break down the bunker, and then use normal HE rounds to complete destruction. Using CP and HE rounds in this combination against bunker positions enables a tank to carry a minimum of CP fuzed rounds in the tank. Experience has shown that six CP fuzed rounds carried as part of the tank's basic load will normally provide a sufficient hole-punching capability during operations when bunkers are in evidence.

#

19. SEATING BASE PLATE OF 60MM MORTAR DURING MONSOON SEASON

During the monsoon season the mortar base plate may sink in the mud, causing the mortar to fire inaccurately.

While in a defensive perimeter a metal 40mm ammo box filled with rocks and dirt makes an excellent surface for seating a base plate. The ammo can should be buried in the ground with the top about 1 inch above ground level.

#

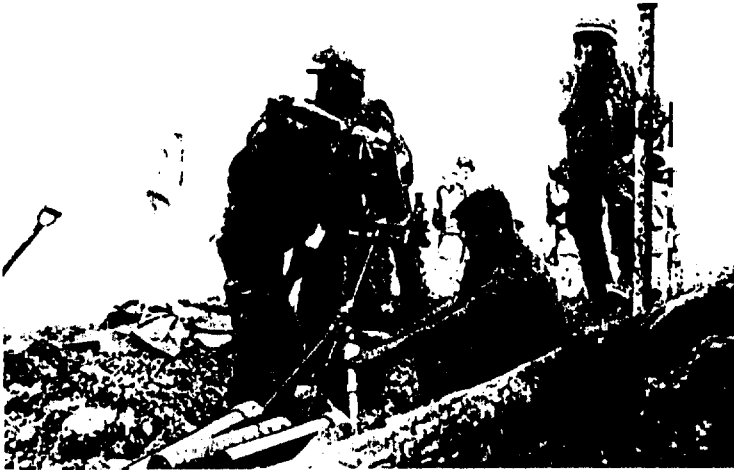

20. SUPPORTING ARMS FIRE REQUEST

Any Marine who can observe a target and has access to the necessary means of communication can request and adjust supporting arms fire. The elements of initial fire requests for NGF, artillery and mortar fire support are shown below:

ARTY, NGF & MORTAR FIRE REQUEST

<u>ELEMENT</u>	<u>EXAMPLE</u>
1. OBSERVER IDENTIFICATION	.. TINGE GOLF, THIS IS SNAKE BITE
2. WARNING ORDER.	.. FIRE MISSION-BATTALION, OVER

ELEMENT

EXAMPLE

- | | |
|-----------------------------|----------------------|
| 3. LOCATION OF | GRID 123456, DIREC- |
| TARGET | TION 1230 |
| 4. DESCRIPTION OF. | 50 VC CROSSING RIVER |
| TARGET | SOUTH |
| 5. METHOD OF EN-. | DANGER CLOSE, HIGH |
| GAGEMENT * | ANGLE, MIXED, VT, |
| | OPEN SHEAF |
| 6. METHOD OF FIRE | ADJUST FIRE, OVER |

* WILL GET AREA FIRE, LOW ANGLE, BE QUICK, PARALLEL SHEAF IF OMITTED.

Once the fire mission has commenced, the observer must send corrections after each firing to the fire direction center. These corrections will adjust the impact of the rounds onto the target. When giving corrections, the following terminology is used:

Corrections

→ Left (right)_____ meters. Used to correct a deviation from the observer-target line.

→ Add (drop)_____ meters. Used to increase or decrease the distance of the bursts from the observer.

The above fire request and subsequent corrections are the minimum required to control a fire mission.

#

21. COUNTERMORTAR FIRE

While countermortar fires are properly functions of artillery at all echelons, the ability to respond immediately to incoming mortar fire with weapons of equal caliber/range by infantry units is highly desirable.

To facilitate immediate response, infantry mortars are laid to cover each horizontal quadrant. Likely enemy mortar position areas are selected within each quadrant based upon range and terrain. When the general direction of incoming fire can be determined, counterfire is immediately returned by the infantry mortars covering the appropriate quadrant. Weapons search and traverse to provide widest possible coverage. During planning of these immediate response countermortar fires, coordination must be made with direct support artillery, countermortar radar coverage, patrol plans, and adjacent units.

#

22. JUNGLE NAVIGATION

Map reading and navigation in open terrain, where landmarks are easily seen and recognized, are fairly simple. In the jungle it is possible to

see only a short distance. For this reason, and the fact that maps of jungle areas are often inaccurate, individuals should be highly skilled in the use of the compass. Landmarks in the jungle consist largely of hills covered with thick vegetation (making it difficult to distinguish one hill from another), streams, and rivers. However, as in any kind of terrain, these landmarks are the surest guides in map reading and navigation.

The isolated nature of jungle terrain, rugged contour of the ground and presence of the jungle canopy make surveying difficult as surveys are accomplished mainly from the air. Although such a method of survey does not provide sufficient detail to show main hill features, ridgelines and streams are generally depicted accurately.

Complete aerial photographic coverage of a given jungle area is usually not available. However, if coverage of specific areas over which troops will move is available, it will prove to be a valuable check. Sterco pairs may be used with a stereoscope for contour determinations. It is important to check the dates of aerial photographs as trails and clearings can become overgrown in a relatively short time.

Marines should be aware of the limited accuracy of jungle maps, however, they should be cautioned not to disregard the map as a navigational aid. Careful map study is an essential preliminary to

jungle navigation. This study will usually reveal the best route to be taken and areas to be avoided. A thorough map study can reward personnel by providing assistance in visualizing the lay of the land, assisting the sense of direction, and increasing confidence.

When doing map studies, the following factors should be considered:

→ It is easier to follow corridors than it is to cross them. Thus, a direct route from one point to another is convenient and fast only in flat jungle. In hilly jungle, such a route may prove to be most demanding physically.

→ Tops of the ridges and hills are usually covered with sparser growth than the valleys. Animal trails are often found on the ridges; therefore, marching on the ridges is usually easier, faster, and less tiring.

→ While large rivers are useful aids to maintaining direction, it is a poor policy to follow them. They are generally meandering, and bordered by dense jungle, and numerous deep sloughs usually punctuate the banks. On the other hand, a streambed may make a good approach route in upland forest when traveling over ridgelines. Marines should be cautioned about the danger of flash floods when using streambeds as routes.



The three most common methods used when following the readings of a compass through jungle are:

- Sighting along the desired azimuth, identifying an object forward that is on line with the azimuth and walking to the object.

- Holding the compass at waist level and walking in the direction of and on line with the set azimuth.

- Sighting the desired azimuth and guiding a man forward until he is on line with the azimuth, then moving to him and repeating the procedure.

The value of the compass in the jungle cannot be over-emphasized. It is vital that each Marine be taught to place complete faith in the compass and that the natural temptation to use one's "sense of direction" should be avoided.

#

23. WATER FOR LONG-RANGE PATROLS

Patrol leaders should make a detailed study before insertion to determine sources of water. Reports from air observers, overflights, and a map study should provide information as to possible sources of water. Location of water sites should be included in the patrol debrief and the information recorded for future operations in the same area.

#

24. PATROL TIPS

While on patrol, STOP briefly every 10 or 15 minutes to LISTEN, SMELL the air, and take a careful LOOK AROUND. People make noise and create distinctive odors. Campsites can be located by their odors or refuse. Try not to smoke for at least 2 hours before going on patrol; smoking tobacco tends temporarily to deaden the sense of smell. The use of spiced or medicated shaving



creams, hair tonics or aftershave lotion tends to saturate one's own sense of smell, so use none at all.

#

25. AMBUSH SAFETY TECHNIQUE

When ambush units are split into separate elements there is always a danger that a misoriented element may trigger a friendly ambush. One technique which will prevent friendly units from inadvertently walking into a friendly ambush is to have

each element occupy its designated ambush site, but not "set" the ambush until receiving a predesignated signal from the senior unit commander. When each element has reported it is in position and no friendly forces require further movement, the ambush leader simultaneously "sets" all ambushes by transmitting the signal. This small precaution may eliminate the possibility of friendly forces engaging Marines of the same unit.

#

26. TROOP COMMENTS/TIPS

The following comments were made by Marines who had recently completed a tour in South Vietnam and were on their way to CONUS.

- "Always dig in when setting in night positions."
- "Never underestimate the enemy."
- "Never get a short-timer's attitude."
- ". . . Stay alert. Everything seems to happen when you are tired and security is lax."
- "Maintain a strict sense of self-discipline concerning all matters."
- "Protective gear (flak jackets, sandbags, etc.) are more than worth any trouble involved in their use."

→ "Keep all weapons as clean as possible. Your life depends on it."

→ "The cloth bags that claymore mines are carried in are excellent ammunition carriers for M-79 grenade rounds."

→ "A styptic pencil is a handy item for use in the field on minor cuts, scratches and leech bites."

→ "Unserviceable air mattresses can be used as machinegun covers, PRC-25 covers, knapsack liners, etc."

#

27. ROAD RECONNAISSANCE

Complete and detailed road classification reconnaissance will normally be performed by an engineer officer. In some instances, it may be necessary for others to conduct a hasty road classification reconnaissance. The below information should be obtained to permit proper classification:

→ Local name of road.

→ Local road number.

→ Obstructions, such as underpasses, fords, large tree limbs, craters, projecting buildings, areas subject to inundation, etc.



- Bridge locations - determine immediate trafficability.
- Tunnel locations - give length, height and width.
- Average width of road.
- Surface material.
- Culvert locations.

#

28. A PICTURE IS WORTH A THOUSAND WORDS

Photography has a wide range of application in the Marine Corps today. Aerial photography can provide a current picture of the ground situation

and assist the commander in determining operational requirements. When interpreted by trained personnel, photography can divulge enemy positions, weapon sites, equipment locations, and recent unit movements. Also, aerial photography can assist the commander in selection of helicopter landing zones, new positions, barriers and minefield sites. Joined together to form a mosaic, aerial photographs may be annotated to serve as a map substitute or map supplement.

On the ground, reconnaissance elements may employ photography as an aid in identifying enemy positions. Captured enemy equipment, personal belongings, maps, and papers may be photographed as a means of recording and documenting the material. Suspected VC or sympathizers may be photographed to create a reference file for later comparison. New or unique enemy traps, mines, weapons, revetments, etc., may be photographed.

Photography may be employed in countless ways. Its use is only limited by our imagination. Employ it as a method of documenting and reporting what we see. Take a picture! It's worth a thousand words.

#

29. KIT CARSON SCOUTS

An excellent use of Kit Carson Scouts has been to place them at bridges or similar vital traffic points during daylight hours. The scouts converse

freely with passing civilians and often learn valuable information relative to enemy activity in the locale.

#



30. STREAM CROSSING

In the event you are crossing a stream supposedly shallow enough for fording and suddenly step into an area over your head, "bobbing" may save your life. Don't panic! Hold your breath and allow yourself to sink a few feet, then jump or bob to the surface for a breath of air, then repeat the procedure. This technique should not be used for deliberate stream crossing.

#

31. TANK RIVER FORDING

While fording a stream, a tank drove into a deep hole which resulted in the tank becoming submerged. Accidents such as this can be prevented if the holes are discovered prior to tanks starting across. A crewmember of the tank should dismount and walk across the stream to determine if any deep holes or other obstacles exist. A length of rope should be tied to the Marine to serve as a safety line.

#

32. HERBICIDE OPERATIONS

The herbicide or defoliation program operates within guidelines established by the U.S. Government and the Government of South Vietnam. Each target must be investigated thoroughly to ensure that these guidelines are met. Careful investigation of tactical need, impact on Revolutionary Development, and other U.S./GVN objectives is essential.

Requests for herbicide operations are normally originated for the following purposes:

- Defoliation to clear fields of fire, minefields, etc., at outposts and camps.
- Destruction of VC-controlled crops.
- Defoliation of NVA/VC secret areas, NVA/VC base camps and routes of communication.

Areas long under VC control can be targeted for long-range herbicide attack. Once approved the target can be attacked any time during the approval period. Forward air controllers operating over the target area locate VC crops, determine the most effective time of attack and request spray missions as required. Basic guidelines to be considered when requesting a herbicide mission are:

→ Defoliation can be carried out at any time of year.

→ Defoliation missions are more efficient if executed in the growing season.

→ Three weeks after a mission is flown defoliation should be noticeable.

→ Trees and bushes under the top canopy will require spray missions after the canopy is defoliated.

→ Herbicide missions may be flown over troops without adverse effects.

A request for aerial spray of herbicides in defoliation or crop destruction may be initiated at any level but must be submitted through both ARVN and U.S. channels. Commanders are encouraged to identify those areas which are not anticipated to be returned to GVN control in the immediate future and the priority of consideration should be given to crop destruction/defoliation requests for

these areas. In approved target areas, aerial spray missions can be flown within 24-48 hours of a commander's request. Conversely, a commander can halt herbicide operations in the area for a specific period during which ground operations are planned.

#

33. MONSOON SEASON OPERATIONAL PLANNING

Until one has experienced the rigors and handicaps of a monsoon season one tends to disregard the experience of others. The problems and solutions for operations in the monsoon season cannot be overemphasized. Planning must be well timed and thorough. The effects of monsoon weather on combat operations are so significant that they dominate virtually all aspects of both planning and operations.

The successful accomplishment of a mission will depend upon the preparation of detailed primary and alternate plans which are designed to accomplish missions under the most unfavorable weather conditions and exploit short periods of advantageous weather.

Normally, the primary plan will be based on courses of action which can accomplish the task in any weather. This precludes reliance on air support in any form. With the limitation imposed by



loss of aerial lifts, resupply, medevac, reconnaissance, and observation, the range and scope of the primary plan is reduced. The staying power of a deployed unit becomes an important consideration. The duration of an operation is calculated on the unit's ability to sustain itself without resupply, to care for and move casualties without evacuation,

and to accomplish its mission without reinforcement. Thus, plans for monsoon operations must allow for increased combat loads and provide for the combat power necessary to compensate for loss of flexibility.

Time-space factors vary widely. For example, a movement to the objective area which may be made in 15 minutes by helicopter in good weather may take 5 hours by foot in marginal weather, and 24 hours by foot in bad weather which requires a circuitous route to avoid impassable terrain and extends the movement into darkness.

A more ambitious alternate plan must be prepared which will capitalize on the use of air support when weather conditions permit. Deploying units must be prepared to exploit the advantage of brief periods of good weather during any phase of the operation. In dense canopy or other unfavorable terrain, the location and availability of helicopter landing zones become of vital concern. Deployed units may use possible LZ's for tactical objectives, maintaining their readiness to increase the range and scope of their operations by keeping "one foot in an LZ" at all times.

Planners of operations down to small patrols must be constantly aware of the sudden and drastic changes in streams, rivers, watersheds, lakes, ditches, rice paddies, and lowlands caused by the heavy rainfall of the Vietnamese monsoons. The primary plan for combat operations during the

monsoon season should provide for the accomplishment of the mission under the limitations of the most adverse weather. An alternate plan should be available to provide for the extension of operations during any phase whenever favorable weather permits.

In addition to the difficulties of conducting operations during the monsoon weather, living conditions can become mighty rough for the Marine on the go. All efforts must be made early to provide:

- Decent tentage.
- Heating means.
- Foul-weather gear.
- Cold-weather clothing.
- Clean clothes. (Provide laundered clothes in a swap process.)
- Hot showers.
- Continuous medical checks for simple things like immersion foot, sores, filth, etc.

#

34. INCOUNTRY TRAINING

The greatest single detriment to improving the effectiveness of subordinate units in the infantry battalion is the lack of training time available to



a unit because of operational commitments. Certain training must be conducted; otherwise errors that are left uncorrected will continue to grow on an ever-expanding basis. In many cases a Marine is not aware of his shortcomings until he is told about them and how to correct them. It would be redundant to list subjects that need constant re-emphasizing. Requirements differ within each unit. The import of a training program is concerned with programing available time to cover weak areas and to "make" time available for proper briefings, debriefings, and critiques of all operations, as these procedures are training vehicles within themselves.

Chapter II: TACTICS

Section 2 - ENEMY



1. ENEMY TACTICS - DMZ AREA

The enemy in the DMZ area is normally disposed in fixed or semifixed positions. He is frequently found in prepared bunkers and fighting holes. The prepared positions are dug in and exceptionally well camouflaged. The bunkers are located at ground level or protrude only inches above the ground. Most positions are located in areas that provide complete concealment from both air and ground observation. The field of fire from these positions is normally narrow, seldom more than 15 meters in width.

Positions are normally prepared in a semicircle with a minimum of security to the rear. The flanks are protected by command-detonated claymore and stick mines, or grenades rigged with tripwires.

Much of the terrain near the DMZ consists of rolling hills that have been cultivated farmland in past years, interspersed with steep, heavily wooded gullies. These farm plots are now overgrown, frequently to a height of 6 feet. The individual plots are bordered by heavy bamboo and thornbush wood lines. In many places where previously trenches had been dug on either side of the wood lines, vegetation now has grown in and over the trenches. As a result, troops can maneuver through them and remain undetected.

The following actions are normally employed by the NVA when contact is made in the vicinity of fixed or semifixed positions in the DMZ area:

- The point or recon element is permitted to close within a few feet of the enemy position before fire is delivered.
- Casualties caused by the initial fires are covered by fire.
- Usually the enemy does not lay down a heavy volume of fire as a "killing zone" and does not open fire unless he has a target.
- The flanks are engaged and an attempt may be made to engage the rear.

- The unit that fires from a fixed position usually remains in position. Additional forces attempt to encircle and fragment the friendly unit.
- When the friendly flanks, rear, and reinforcing units are fixed, mortar and artillery fire are delivered.
- Close contact is maintained at all times to negate the effectiveness of friendly supporting arms.
- Contact is broken only when the situation becomes unfavorable to the enemy.
- The enemy prefers to make contact near nightfall and continue fighting until shortly before daylight.

#

2. NVA AMBUSH TACTICS

The usual provision for point and flank security, and the advantage resulting from its use, cannot always be realized when certain situations and conditions of terrain exist. The situation might be the necessity of moving from point A to point B within a given timeframe. The terrain condition might be such that the effective use of flank security is not possible due to heavy, impenetrable brush. The NVA is quick to take advantage of any channelized or restricted movement situation.



Action involving a battalion command group and two companies illustrates the point. The brush on both sides of the trail, leading to the top of a hill was impenetrable, and the use of flankers was impossible. The commanding piece of terrain, vital to the mission of the unit, would either have to be occupied or it would dominate whatever position one took in its vicinity. The enemy permitted the column to

advance to the summit of the hill mass, attacked the point and then brought the column under fire from completely concealed bunkers located alongside the trail every 15-25 yards. The immobilization of the column was followed by a mortar attack on the trail to which the bunkers were impervious. Two platoons reinforced the lead company but the contact was so close that the effective use of supporting arms was negated. Through pinpoint control and accuracy of friendly mortars and the aggressiveness of troops, the enemy positions were taken, but at a cost. The enemy had laboriously cut his way in from the backside of the trail, pulling the brush in behind him, dug small positions alongside the trail, with apertures no more than a foot above ground level, and then, by reaching forward, cut a small field of fire (almost at ground level) to the trail. The bunkers were well-built, extremely well camouflaged and impervious to anything except a direct hit.

When conditions described above are encountered, the following procedures should be given consideration:

- ➔ Utilization of a particular tactic/technique or weapons system will be dependent upon availability and the necessity for rapid movement.

- ➔ CS gas, when satisfactory wind and weather conditions prevail, can assist in forcing the enemy to reveal his presence.



→ Have the point drop to the ground every few yards and investigate the brush very carefully on both sides of the trail. The small fields of fire are cut close to ground level and are detectable if the men know what to look for.

→ Use napalm on brush adjacent to trails. Once burned off, the enemy is usually found to have pulled out of position or died while attempting to do so.

→ Adjust 155mm or larger artillery to cover areas adjacent to trails. Smaller caliber artillery will not penetrate bunkers.

→ Utilize 90mm tank guns to fire into these same areas prior to moving up the trail.

→ Flame tanks can be used with a high degree of effectiveness for the relatively short duration of their fuel capacity.

Trail networks harboring enemy are usually well outposted and the initial action consists of a brief firefight with one of these outposts. Contact will be broken and upon pursuit additional outposts will be encountered. This pattern indicates the strong possibility of a trail-type ambush along the described lines.

#

3. USE OF CIVILIANS BY ENEMY TO MASK AMBUSHES

During a convoy escort by tanks from the Rock Pile to Ca Lu, the tank platoon commander noted a group of civilians moving toward them directly in the middle of the road so as to slow down and block traffic. This was an unusual event compared to numerous other road marches when civilians gave the column a wide berth. The adults appeared nervous and clutched their children close to their sides. Moments later the entire convoy came under intense mortar and antitank fire from both sides of the road.

Platoon commanders must be alert to unusual actions by civilians. In the above case, the civilians were either forced by the VC to impede the column's progress or the civilians were aware of the VC presence and attempted to clear the area. Special alertness for ambushes should be exerted in the case of unusual civilian actions.

#

4. ENEMY MINE WARFARE

Mine warfare needs to be repeatedly emphasized, particularly in light of ground operations being conducted in South Vietnam. Because of his limited ability to use major supporting arms, the enemy has developed a broad employment of mine



warfare to harass by inflicting casualties and damage. Mines and explosives devices are used to deny the full-time use of main supply routes, and to channelize tactical formations in attempts to increase their susceptibility to ambush and booby-traps. Based upon information collected during an extensive survey, the areas most widely used by the enemy for antipersonnel mines and devices have been:

- Likely CP areas.
- Higher ground, ridgelines and built-up secondary roads and dikes.
- Hedgerows and tree lines.
- Shady areas.
- Trail junctions.
- Fence lines and gates.
- Helicopter landing zones.

The majority of mines have been found in locations seldom used by the local populace. There have been instances where patrol bases were evacuated for a period of 4 to 6 hours and upon the patrol's return, the area was found to have been mined. Engineer teams have found that areas which they had just completed clearing were mined behind them.

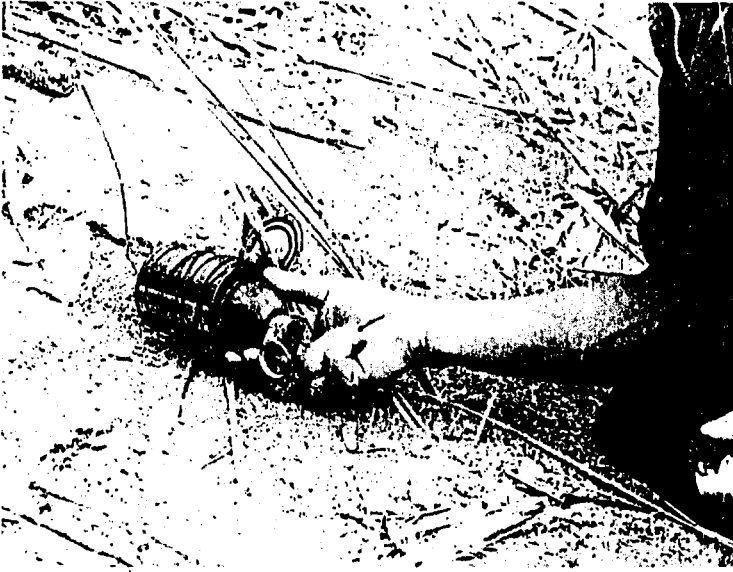

Captured ordnance, including dud artillery and mortar rounds, accounts for the majority of devices discovered. Almost all the antitank mines located have been improvised from artillery rounds or composed of packaged explosives rigged with command- or pressure-detonating devices. The most disturbing fact is that the preponderance of mines and boobytrap devices encountered are of U.S. origin. It is imperative that Marines not permit potentially lethal items to fall into enemy hands.

#

5. ENEMY PROBES AND MINING ACTIVITY

A detailed study of enemy mining activity on a road near a combat base revealed a definite

relationship between probes of the combat base perimeter and the emplacement of mines on the nearby road. The enemy were using probes of the perimeter as a cover for their mining activity. The VC began their attacks shortly after dark, directing the thrust of their probes at friendly positions which could observe activity on the road. The attacks were mounted from such a direction as to draw the attention of Marines at these positions away from the road. The choice of early evening to conduct the probe is significant in two respects:

- Rain during the night will make indications of roadway mining more difficult to detect the next day.
- Enemy early evening probes delay the departure of friendly patrols and ambushes, which are normally sent out at that time.

Where possible, alternate positions should be occupied to maintain surveillance along roads during enemy probing attacks. Artillery fire missions, using VT fuzes, should be called on roads where mining activity is probable during an enemy probe.

#

6. MINES AND EXPLOSIVE DEVICES EMPLOYED BY THE VC/NVA

Listed below are some of the mines and explosive devices employed by the VC/NVA:

- Dud Shell Mine. The dud shell mine is improvised from a dud artillery or mortar projectile

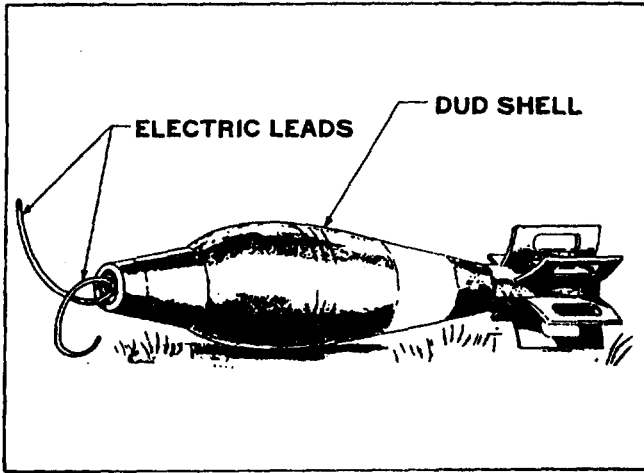

Figure 2-1

(fig. 2-1). The mine is made by removing a fuze from a projectile and drilling a hole into the explosive for an electric detonator. Batteries or a handheld generator supply the current to activate the detonator remotely. The mine is usually found alongside roads or trails. Its effectiveness against armored vehicles and personnel varies with the type and size of projectile used.

→ Chinese Communist No. 4 Dual-Purpose Mine. The Chinese Communist No. 4 dual-purpose mine was designed for use against both personnel and light vehicles (fig. 2-2). It incorporates a double-acting fuze which will initiate the explosive charge under either of two circumstances: when a load of 300 to 500 pounds is applied to the pressure spider; or when a pull of 10 to 50 pounds is exerted

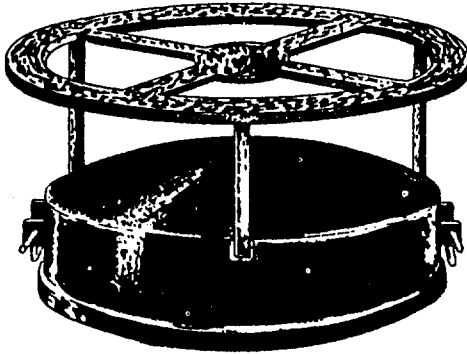

Figure 2-2

on a tripwire fastened to the fuze's striker-retainer pin. The mine is rustproofed with a compound similar to cresote, and the joint between the two halves of the case is caulked. No. 4 mines are packed in individual metal carrying cases.

→ Tin Can Antipersonnel Mine. The tin can mine is constructed from a sheet metal container similar in appearance to a beer can (fig. 2-3). The firing device for the explosive is an improvised fuze with zero delay action. A handgrenade fuze may be used with this munition by removal of the delay element. The mine functions by a tripwire attached to the pull-ring device, which when removed allows the spring-driven striker to move downward, hitting the primer and detonating the mine. This mine should never be neutralized by hand because of the possibility of a hangfire.

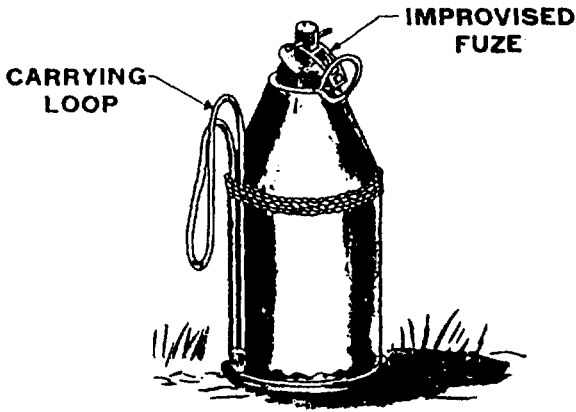

Figure 2-3

→ Concrete Fragmentation Mine. The concrete fragmentation mine is constructed of explosive encased in cylindrically shaped concrete with a flat side for stable emplacement (fig. 2-4). A 2-inch-diameter pipe on one end of the mine head serves as a carrying handle and detonator housing. The two swivels on top of the mine are used to tie it to an object. The mine's electrical detonator usually is activated remotely by means of a battery pack or handheld generator.

→ Bounding Fragmentation Mine. The bounding fragmentation mine is improvised from a U.S. M2 bounding mine or M48 trip-flare mine cases (fig. 2-5). A wooden cylinder, slightly smaller in diameter than the mine case, is hollowed out so that a standard grenade (frequently the U.S. M26) can fit

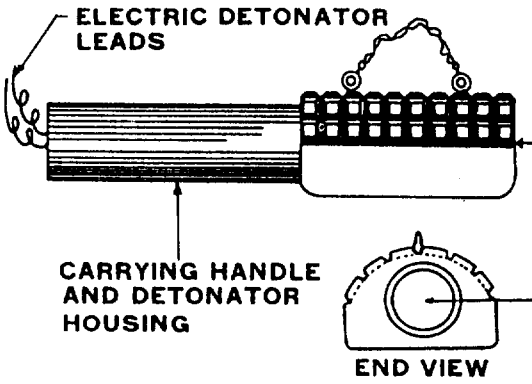

Figure 2-4

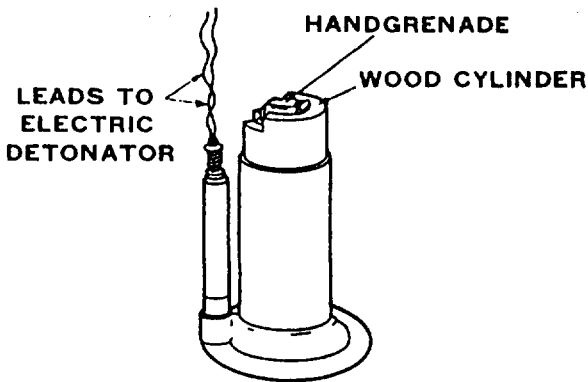

Figure 2-5

inside. The wooden cylinder, with enclosed grenade, is then fitted into the mine case and the grenade's safety pin is extracted. When the mine is initiated electrically, either by a battery pack or a handheld generator, the cylinder with grenade leaves the case, the handle flies off and activates the grenade.

→ Mud Ball Mine. The mud ball mine consists of a handgrenade encased in sun-baked mud or clay (fig. 2-6). The safety pin (pull ring) is removed, and mud is molded around the grenade. After the mud dries, it holds the lever of the grenade in the safe position. The mud ball is placed on trails or anywhere troops may walk. Stepping on the mud ball breaks the dried mud apart and releases the

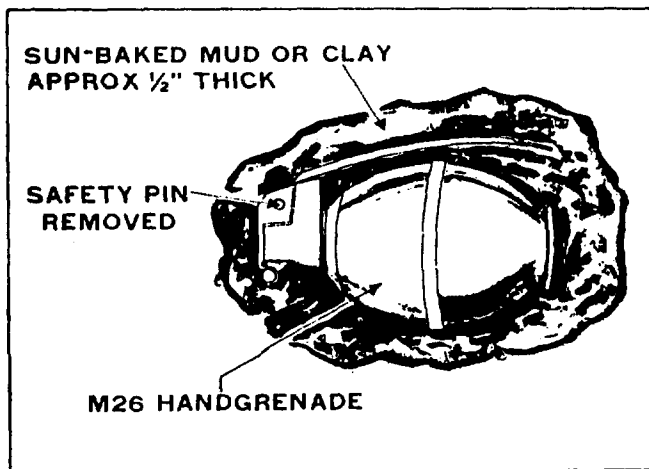

Figure 2-6

lever, detonating the grenade. The U.S. M26 handgrenade has been the most commonly used grenade for this purpose although other lever-type grenades may be used.

→ Cast Iron Fragmentation Mine, AP. This antipersonnel mine, made of cast iron, resembles a stick handgrenade with a very short handle (fig. 2-7). The word "Min" is often found cast into the body. The handle houses a pull-friction, delay-type fuze. A tug on a tripwire attached to the pull wire of the friction fuze will, by extracting the pull wire, ignite the delay element.

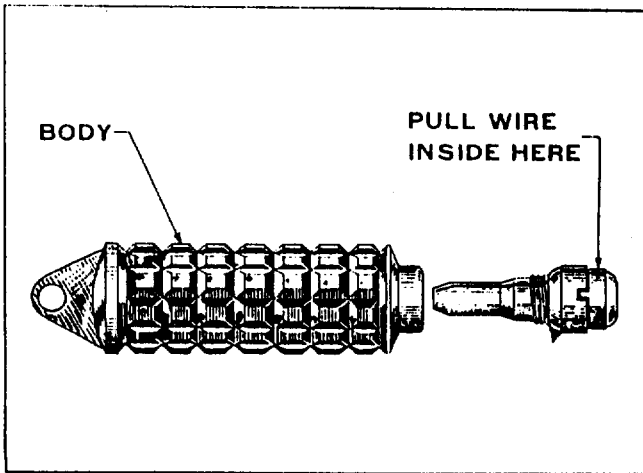

Figure 2-7

→ Cast Iron Fragmentation Antitank Mine. Sometimes referred to as a pineapple fragmentation

mine, this is a unique egg-shaped mine constructed of cast iron and is further identified by surface serrations and a carrying handle (fig. 2-8). The mine has a single fuze well located in one end of the body. It is fuzed with an electric detonator which is activated by current from batteries or a handheld generator.

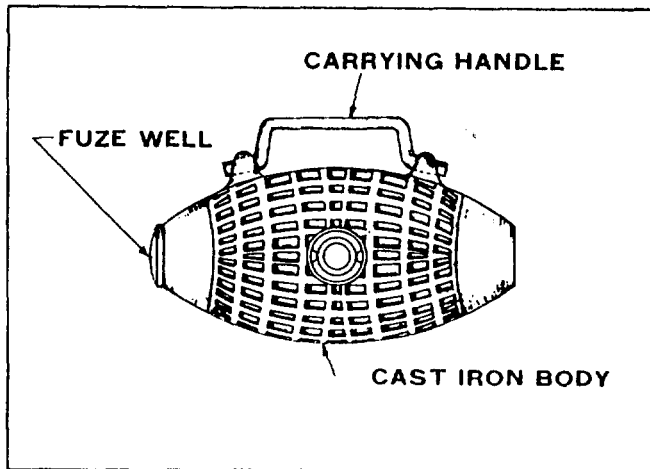

Figure 2-8

→ Shell Case Mine. The shell case has a standard artillery shell casing, mostly 75mm, 105mm and 155mm calibers (fig. 2-9). A variety of fuzing mechanisms can be improvised for this mine; the mine illustrated is detonated by the potato-masher grenade inserted into the explosive charge. Inserted into the side of the casing are two fuze wells through which electrically or mechanically

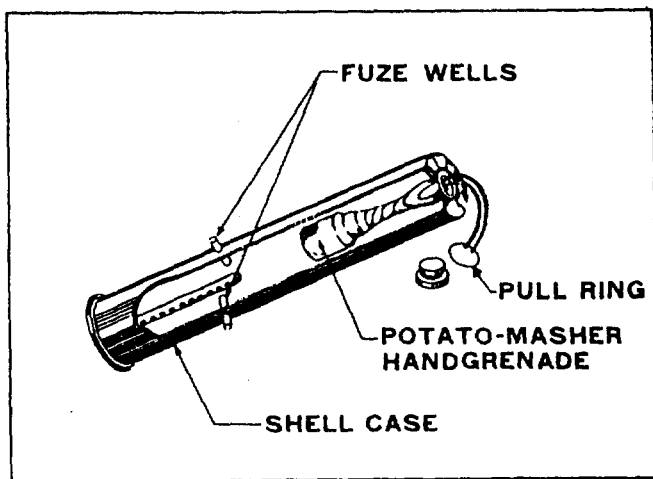

Figure 2-9

initiated fuzes may be placed. The mine, generally used in an antipersonnel role, is initiated by a pull on a tripwire strung across a path. In an anti-vehicular role, the mine is usually command-detonated electrically.

→ Directional Fragmentation Mine (DH-10). This directional mine is primarily an antipersonnel mine which also can be used against thin-skinned vehicles (fig. 2-10).

The concave front or fragmentation face of the mine contains approximately 450 half-inch steel fragments embedded in a matrix, and is backed up by cast TNT. Designed for electrical detonation, the mine is provided with an adjustable frame so that it can be placed on various types of surfaces

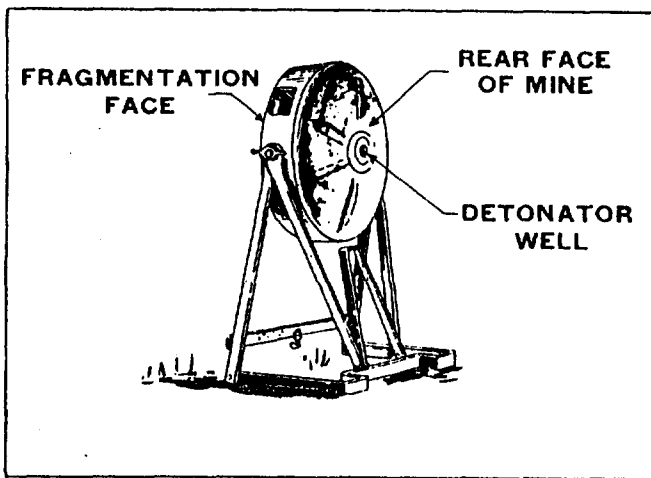

Figure 2-10

and aimed in any direction. The single fuze well is centered on the convex (back side) of the mine. This mine is often referred to as a VC claymore mine.

→ Hollow Bamboo Mine. This mine is made from a large piece of bamboo (fig. 2-11). It is hollowed out and filled with plastic explosive or black powder, together with nuts and bolts, rocks, and scrap metal, or other available material for missile effect. A pull-friction fuze is normally used. This mine may be command detonated with an electrical firing system. It has been used as an improvised demolition charge.

→ VC "Toe Popper" Mine. This mine is fabricated from cartridge cases or pieces of pipe varying in size (fig. 2-12). It is loaded with a charge

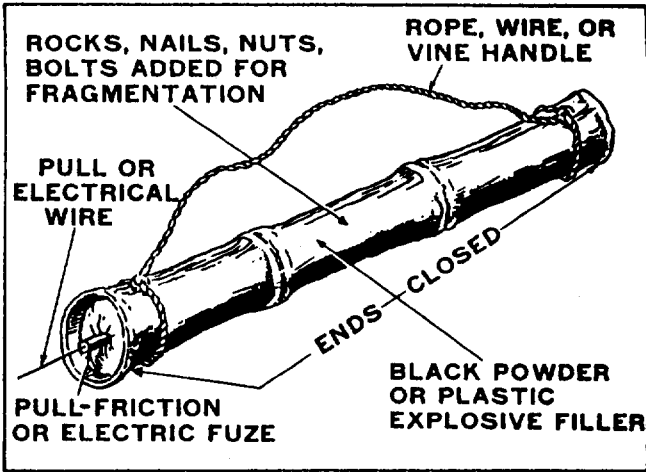

Figure 2-11

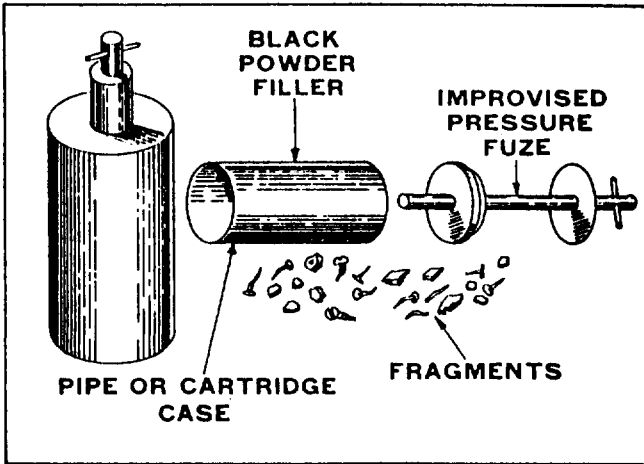

Figure 2-12

of black powder, a primer, and a variety of fragments for missile effect. When the victim steps on the mine, the igniter explodes the black powder charge and propels the fragments upward.

→ Pole Charge. The pole charge (fig. 2-13) consists of a quantity of explosive wrapped in waterproof material (such as a piece of tarpaulin or canvas) and lashed to a 3-foot or 4-foot pole. The explosive is ignited by a piece of time fuze crimped to a nonelectric detonator. Pole charges are generally used during assaults for destroying barbed wire entanglements and bunkers.

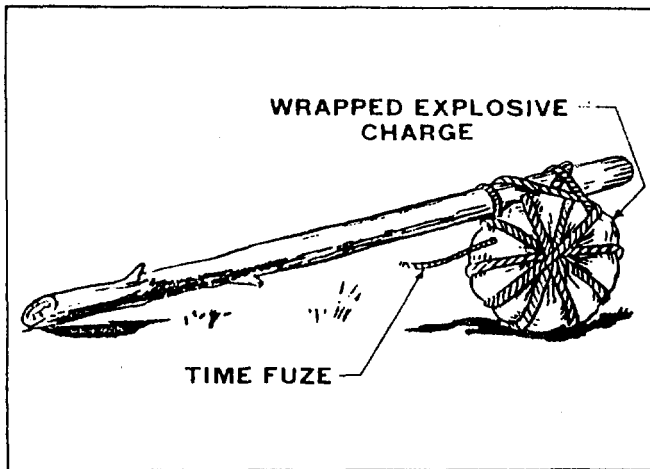

Figure 2-13

→ VC Satchel Charge. This VC charge is made from waterproof cloth, rope, wire, or bamboo

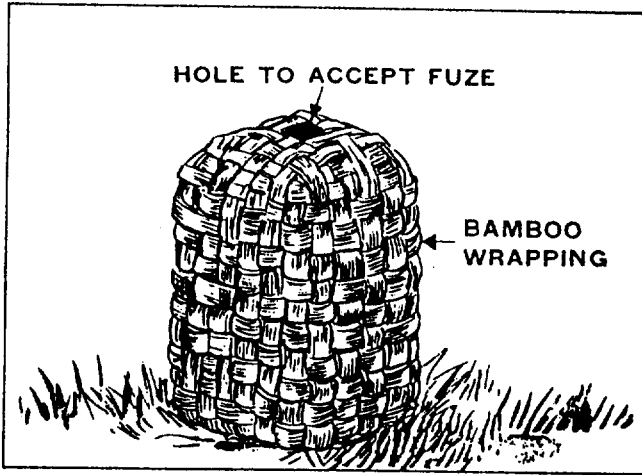

Figure 2-14

strips; 2.3 to 4.6 kg (5 to 10 lb.) of explosive; and the detonator, which is in the handle, of a stick grenade (fig. 2-14). Extreme caution must be exercised when handling these charges because potassium chlorate, a sensitive explosive, may be found in them. The VC satchel charges have been used for destroying bunkers and fortifications during enemy assaults and for other types of demolition work.

→ Pressure-Electric Firing Device (Anti-personnel). The pressure-electric firing device consists of a wood frame; a movable, spring-loaded wooden pressure piece attached to a bolt; and a length of double-strand electric wire (fig. 2-15). One strand of electric wire is attached to the bolt; the second strand (bare) is fastened to the frame.

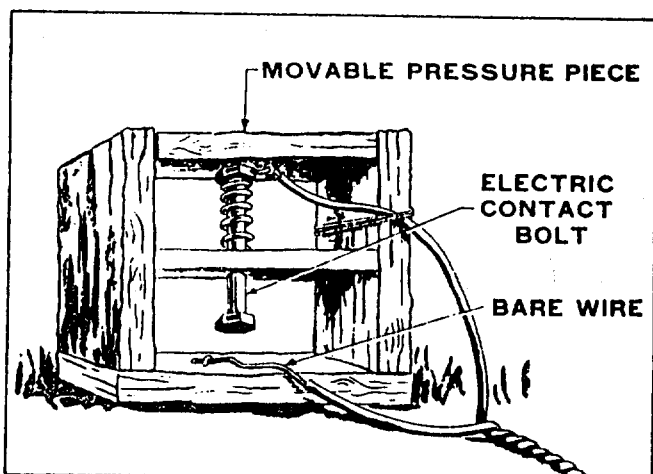

Figure 2-15

When an individual steps on the device, the pressure plate moves downward so that the head of the bolt contacts the bare strand of wire, completing the circuit through the electric detonator which then detonates the device.

→ Stick Handgrenade. The stick handgrenade, used extensively by the VC comes in several sizes-- differentiated by lengths of handle and sizes of fragmentation heads (fig. 2-16). This grenade functions by a pull string enclosed in the handle and attached to a copper wire coated with a match compound. Normally the match compound ignites a 4-second delay element, but a number of these grenades have been found with no delay element.

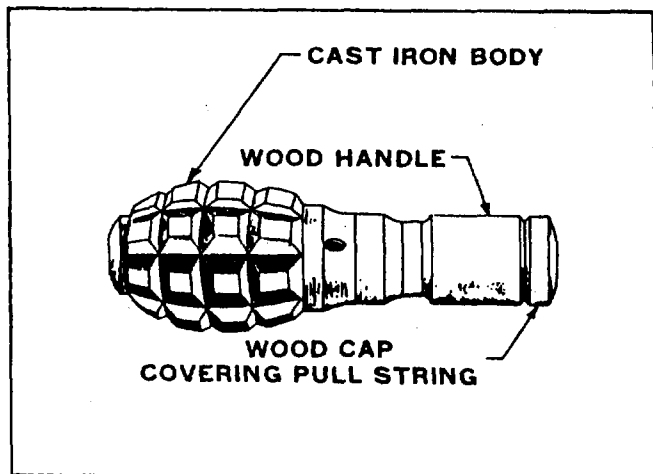

Figure 2-16

➔ Defensive Handgrenade. The defensive handgrenade, of serrated cast iron, functions in the same manner as similar U.S. handgrenades (fig. 2-17). When the safety pin is removed and the grenade thrown, the safety lever releases the spring of the mechanical firing device which ignites the primer and delay element of the fuze. This grenade is readily adaptable to use as a boobytrap.

#

7. VC MINE INDICATORS

It is evident from past experience that the VC mark some mine and boobytrap locations; however, a clear-cut doctrine for marking is not so evident.

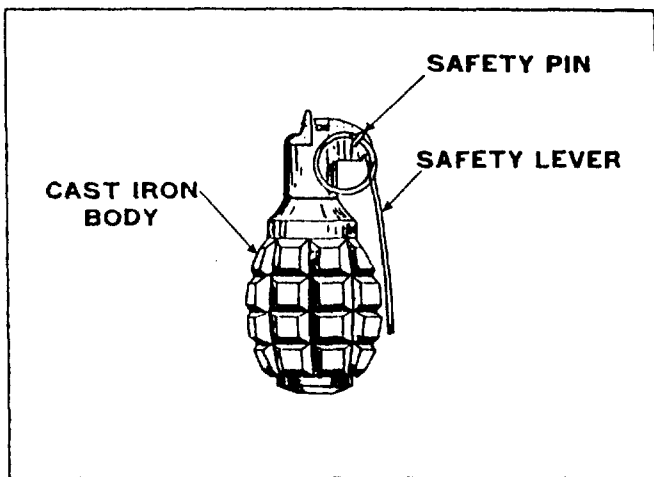

Figure 2-17

Several methods of marking roads and trails to indicate explosive locations are used. All of these make use of sticks or stones arranged in a pattern (figs. 2-18 and 19). Broken sticks have been used to indicate that mines are located in the direction of the break.

The locations of mines or mined areas may be more closely marked by other methods, three of which are shown here. One method is to lash sticks in the form of a "goalpost" (fig. 2-20). This marker usually means that there are mines in the immediate area. The second marker (fig. 2-21) consists of clumps of grass tied together at the four corners of a 2-meter square. The mine is then emplaced in the center of the square. The

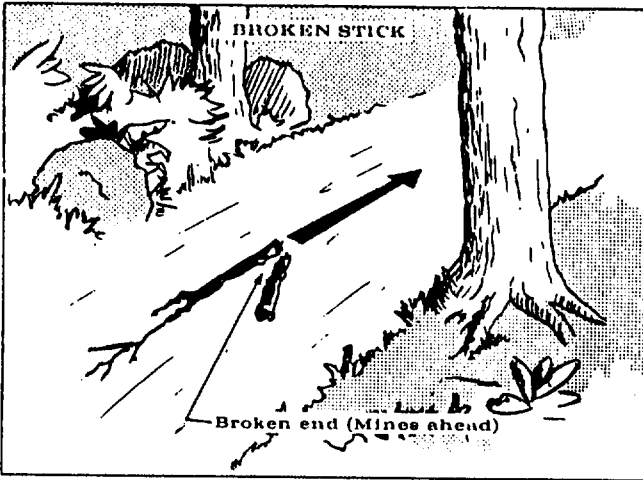

Figure 2-18

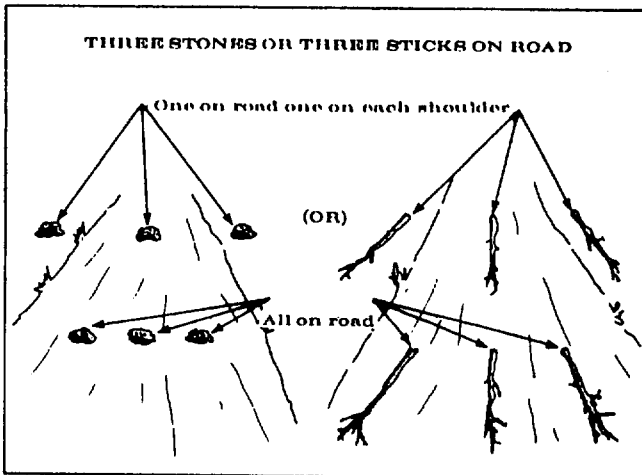

Figure 2-19

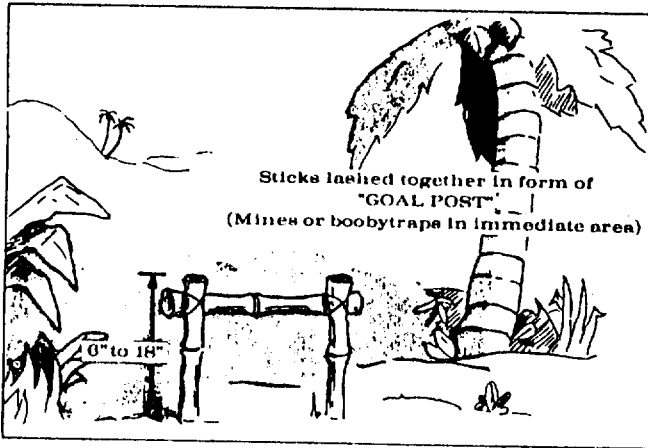

Figure 2-20

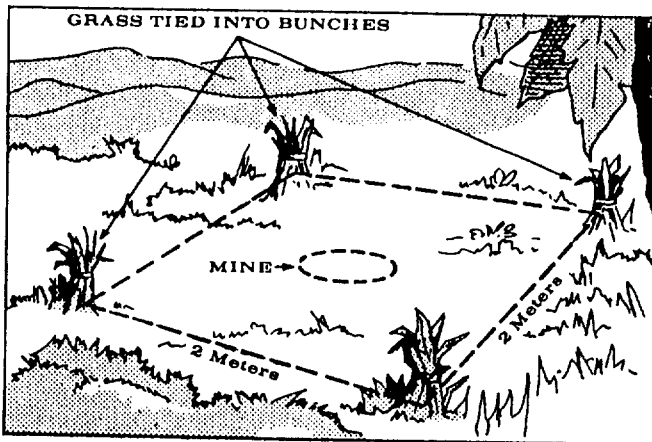

Figure 2-21

third marker (fig. 2-22) consists of a 12-inch stake with a notch 3 inches from the top; mines have been found within a 10-meter radius of this marker.

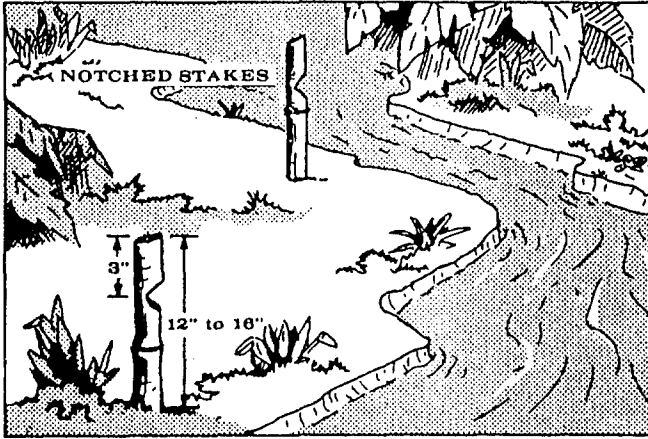

Figure 2-22

Marked boobytrapped dwellings, caves, and tunnels have also been found. From one to three pieces of string are placed at or above the entrance, denoting that the installations are boobytrapped (fig. 2-23). There is no regularity as to the length, type, material, or color of strings used. As with most markings, the strings are inconspicuous to the casual observer, but apparent to the VC.

All of the illustrated methods of marking indicated the presence of mines or boobytraps in the area, and can indicate to the VC the particular direction and distance to the explosive. The specific meaning of these markings can be changed from day to day; therefore, personnel should not attempt to remember specific meanings, but should be especially alert when markings are discovered. Do not try to second guess the meanings of VC mine

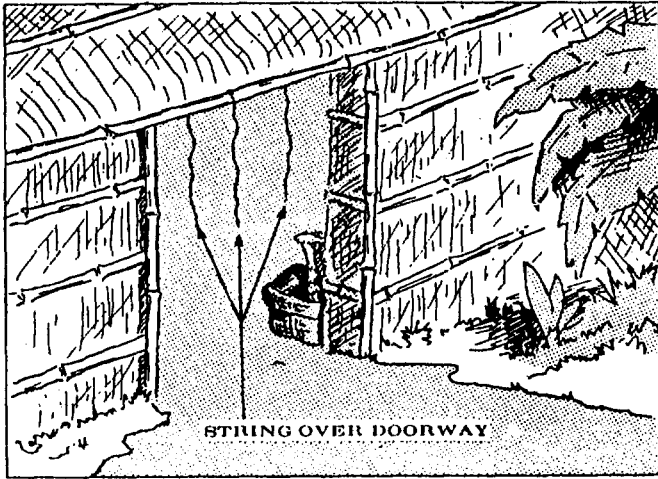

Figure 2-23

markers - do be alert when a mine indicator is spotted.

A familiarization with warning devices employed by the VC to mark positions of boobytraps can prove invaluable to infantry units in the field and may greatly reduce needless casualties. It has been noted that a frequently used marker is constructed with two 5-foot-bamboo stakes. The first stands erect while the second, standing 12 inches away is bent over at the top and tied to the first. The bent pole points away from the boobytrap and is usually placed five feet from it. It is further noted that every boobytrap located in conjunction with this particular marker has been a mortar projectile rigged with pressure-type detonator.

#

Chapter III: AVIATION



1. AIR-TO-AIR REFUELING

An article on air-to-air refueling procedures appeared in the September 1967 issue of Professional Knowledge Gained From Operational Experience in Vietnam. The information contained in the article has since been superseded by revised procedures contained in NATOPS Air Refueling Manual dated 15 November 1967.

To ensure clarity and understanding, the article is reprinted and contains the revised procedures as shown below.

Reports of increasing numbers of aerial refueling incidents should prompt a review by all personnel concerned of NATOPS air refueling procedures. Immediate recognition of the meaning of the light signals on the refueling pod is vital. These light signals are shown here:

- | | |
|---|--|
| 1. Steady Amber Pod Light (Before Engagement) | Ready Tanker
(Tanker system ready, but does not constitute clearance to engage.) |
| 2. Steady Amber Pod Light (After Engagement) | Ready Tanker
(Receiver aircraft is outside the refueling range of 20 to 80 feet of hose extension.) |
| 3. Red Pod Light (Before Engagement) | Do not engage; Tanker not ready. (Hydraulic pressure off.) |
| 4. Red Pod Light (After Engagement) | Disengage; Tanker malfunction. (Hydraulic pressure off.) |
| 5. Steady Green Pod Light | Fuel flowing |

- | | |
|---------------------------------|--|
| 6. Blinking Green Pod
Light | Intermittent fuel flows;
receiver full or system
malfunction. (Do not
disengage until cleared
by the Refueling Area
Commander.) |
| 7. Bottom Rotating
Beacon On | Emergency Breakaway |

"Dead" hoses should be utilized only as an emergency procedure. A hose without pod lights may be a good hose with the light bulbs burned out but should be confirmed by the tanker prior to engagement. If a "dead" hose is utilized, extreme care must be exercised. Minimum possible closure rate is necessary to preclude bending or breaking the receiver probe, and once engaged, receiver position must be precisely maintained to minimize hose slack and the resultant whip. Disengagement should be smooth and steady instead of an emergency breakaway.

#

2. ANGLE OF ATTACK CIRCUIT BREAKER ON CENTER AFT CONSOLE (AGA AIRCRAFT)

The pilot took off and raised the gear handle. Both mains went to barber pole and then "up" as normal. The nose gear indicated down and locked, but was actually up and locked. The pilot cycled

but was unable to get an "up" indication on the nose gear, had to assume the gear was as indicated and aborted the mission. Angle of attack seemed to work properly on landing. The wheel transition light went out when mains indicated up and locked, indicating that all three gears were up and locked.

After landing it was noted that the angle of attack circuit breaker had popped (prior to lift-off). When this happens:

→ The nose gear indicator (only) will remain in the position it read prior to the circuit breaker popping.

→ The angle of attack will function properly in a counterclockwise direction only (from fast to slow attitude, but not from slow to fast).

Pilots should check the angle of attack circuit breaker when such an occurrence happens after lift-off, or prior to landing. (NATOPS makes no mention of the above.)

#

3. AMTI MISSIONS

The search radar of the A6A aircraft is capable of canceling out all returns except those from moving targets. During AMTI (airborne moving

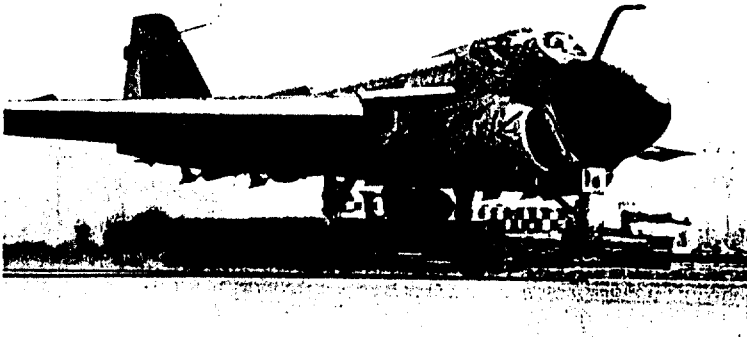

target indicator) missions, this action can present a navigational problem when visual ground reference is not possible. It is common practice for bombardier/navigators to switch from the AMTI mode to the normal mapping mode when navigational assistance is required. This requires a considerable amount of "knob twisting" and causes a significant loss of reconnaissance time. This loss of time can be diminished by use of the secondary trigger on the search radar. By building a good mapping picture on the secondary trigger and utilizing the primary trigger for AMTI, an almost instantaneous check on the aircraft's position can be made without losing mission time.

#

4. TURN AND SLIP CIRCUIT BREAKER, AFT CENTER, A-6A AIRCRAFT

This circuit breaker has been known to pop in flight resulting in the temporary loss of the turn and slip indicators. More noticeable is the low fuel warning light which also comes on. The totalizer and fuel quantity needles will register properly, but until the turn and slip circuit breaker is reset by the pilot or bombardier/navigator the low fuel warning light will remain on.

Pilots unaware of this peculiarity will suspect fuel quantity problems and may abort a mission if the low fuel warning light comes on for no apparent reason.

#

5. FLIGHT CONTROL FAILURE FOLLOWING LOSS OF HYDRAULIC PRESSURE IN F-8E SERIES AIRCRAFT

A 1st MAW F-8 crashed after incurring battle damage which caused the subsequent failure of the hydraulic power flight control system. This crash was characterized by a loss of hydraulic pressure followed by an uncontrollable downward movement of the aircraft with attendant severe negative G-load. Once this downward movement is experienced, the use of normal ejection procedures by the pilot may become impossible.

When an F-8E aircraft experiences partial or potential failure of the power control hydraulic systems, especially when battle damage is the cause, the pilot should immediately grasp the alternate ejection seat firing handle while continuing to fly the aircraft. If a loss of flight controls follows, he will be able to initiate the ejection sequence.

#

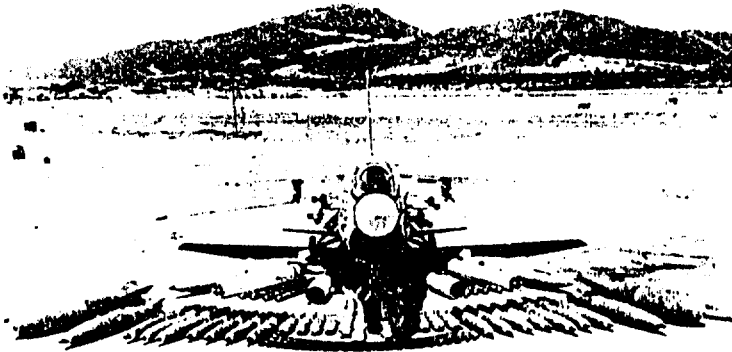

6. ZUNI LAUNCHERS F8 AIRCRAFT

The aviation ordnanceman must constantly keep safety considerations in mind when handling and preparing munitions for employment. Thorough testing, inspection, and attention to detail are

mandatory to prevent careless mistakes which can turn a potentially successful mission into a nightmare for the pilot.

The LAU 33/A and LAU 35/A ZUNI rocket launchers, which are attached to the fuselage of the F8 aircraft, are a case in point. A micro-switch is located within the structure of these rocket launchers and serves as a safety feature. When the safety pin is properly inserted, the micro-switch interrupts the electrical circuitry within the launcher. It has been determined that the safety pin can be inserted behind the actuator arm of the microswitch instead of in its proper forward position. This negates the purpose of the safety pin and sets up an extremely unsafe condition. A similar unsafe condition exists if the pin is properly inserted, but the microswitch sticks because of extended usage.

To prevent an unsafe condition from occurring with the ZUNI launcher, follow correct procedures, inspect the equipment, and perform stray voltage checks. When using the safety pin, ensure that it is properly seated in the proper hole. Move the actuator arm of the microswitch and listen for the distinct clicks which indicate that the switch is properly operating and not sticking. If no clicks are heard, or the movement of the actuator arm appears restricted, do not use the launcher! Remember that Safety is First - Last - and Always.

#

7. FUEL DUMP VALVE OPERATION IN THE A-4E AIRCRAFT

On occasion the fuel dump valve in the A-4E has stuck in the dump position. In this condition, without further positioning of the switches, the only fuel remaining upon completion of the dumping process will be the 1500 pounds in the fuselage tank.

It is not a safe practice to dump fuel until a landing is assured. In the event that there is fuel remaining in an external tank, it may be saved for use by activating the fuel transfer bypass switch. The external tank fuel will be available even though the wing dump valve is open.

#

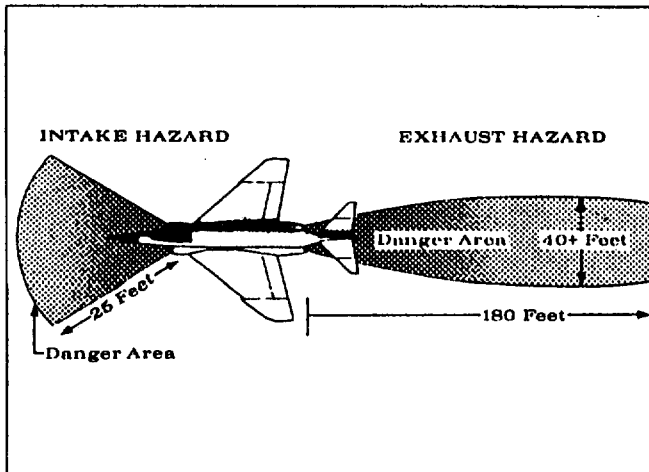

8. DANGER - JET BLASTS

Jet engine intakes and exhausts are extremely dangerous. The sketch shows a diagram of a typical jet danger area. Each Naval Air Training and Operating Procedures Standardization Manual has a pictorial diagram of the danger area for each specific aircraft. Supervisors should ensure that all personnel who work in the vicinity of jet aircraft are aware of the limits of danger areas.

#

9. HELICOPTER CONSERVATION

The requirements for helicopters in Vietnam are many and varied. To ensure maximum benefit from available Marine helicopter assets, conservation practices must be followed. A few examples of practices that will reduce lift requirements and conserve helicopter assets are shown below:

- Utilize ground vehicles, fixed wing aircraft, or landing craft to the maximum extent when the tactical situation does not require the use of helicopters.
- Select carefully all landing zones to preclude any requirement for additional helicopter movement due to a landing zone being unable to accommodate forces or supplies.
- Plan for full utilization on both legs of each flight. Flights from home base to pickup zones should have a planned load, if possible.

→ Helicopters performing in a direct support role should not be allowed to sit idle. If their services are not required, they should be returned to the DASC for other employment.

→ Avoid servicing helicopters at those locations where logistics requirements have to be satisfied by airlift.

#



10. HELICOPTER GROUND FIRE

Review of helicopter ground fire hit statistics reveals that the probability of being hit by enemy ground fire increases as helicopter altitude decreases. Helicopter hit reports show that over 55%

of the hits by ground fire occur below 500 feet. An additional 30% of the hits occur between 500 and 1000 feet. The remainder of the in-flight hits by ground fire occur primarily between 1000 and 2000 feet with only 2% occurring above 2000 feet.

It is apparent that helicopter flight profiles above 2000 feet should be sought. However, weather conditions or mission assignment may, at times, preclude scheduling flight at altitudes over 2000 feet. A significant alternative that should be considered, when flights within the 0 - 2000 feet envelope are required, is flying at an altitude of less than 100 feet. Ground hugging leaves little time for enemy gunners to react to the helicopter's presence.

#

11. HELICOPTER DAMAGE CAUSED BY RADIO ANTENNAS

Due to extensive use of helicopters in transporting troops and supplies, a continuing hazard exists for unknowledgeable individuals who approach a helicopter while the blade is turning. Individuals have been known to drive vehicles with radio antennas too close to the blades, resulting in severed antennas, damaged rotor blades, and flying debris dangerous to bystanders and helicopters. Backpack radios with long antennas constitute an equal hazard. Personnel involved in operations around aircraft must be indoctrinated

on the possible hazards of rotating blades. Control of vehicular movement around airfields and landing zones must be rigidly enforced.

#

12. HELICOPTER NOTE, GROUND RESONANCE

Helicopter pilots have been exposed to ground resonance since the inception of the fully articulated rotor system. This characteristic is not an everyday occurrence but it does happen and can cause destruction of helicopters. The infrequency of occurrence in itself tends to increase aircraft damage in that most pilots are inexperienced and unfamiliar with the phenomenon. Questions which arise in relation to ground resonance are: What is it? What causes it? How can it be eliminated?

Ground resonance is a vibration which occurs when a coupled interaction exists between the rotor system, the fuselage and the ground. For the phenomenon to occur, there must be an abnormal lead/lag blade condition in the rotor system causing extreme vibrations due to an unbalanced rotor head center of gravity. The vibrations are transmitted through the fuselage to the ground and back, further exciting and aggravating the unbalanced condition and ultimately causing destruction of the helicopter.

#



13. DAMAGE TO ARTILLERY WEAPONS CAUSED
BY IMPROPER RIGGING FOR EXTERNAL
CARRY BY HELICOPTERS

Four 105mm howitzers have been damaged because they were not properly rigged for external helicopter carry. In all cases a normal hookup was effected, but during liftoff, the howitzers shifted position and the muzzles struck the ground. The responsibility lies with the supported unit to have cargo properly staged and rigged for transport. It is imperative that the supported unit possess qualified personnel to prepare cargo for lift by helicopter.

#

14. IMPROPER LOADING OF THE CH-53A HELICOPTER

The CH-53A is capable of transporting many diverse loads of cargo internally. Due to the basic design limits of the ramp and conveyer assembly, caution must be observed in order that these components are not overstressed. The loading ramp is designed for a 3,000-pound load. The designed stress limitation on the conveyer assemblies utilizing the standard 40" x 48" pallet is 2,200 pounds per pallet.

The use of multiple forklifts and pallets should not be overlooked during the planning phase. If oversized cargo cannot be lifted by a 3,000-pound forklift, multiple lifts and pallets MUST be utilized to protect the aircraft from structural damage. When loading cargo of appreciable length and weight, the supported unit must be aware of the design limitations of the aircraft so that the cargo loading ramp and conveyer assemblies are not inadvertently overstressed. A continuous training program should be in effect to ensure that all helicopter support team personnel are aware of the basic aircraft structural limitations.

#

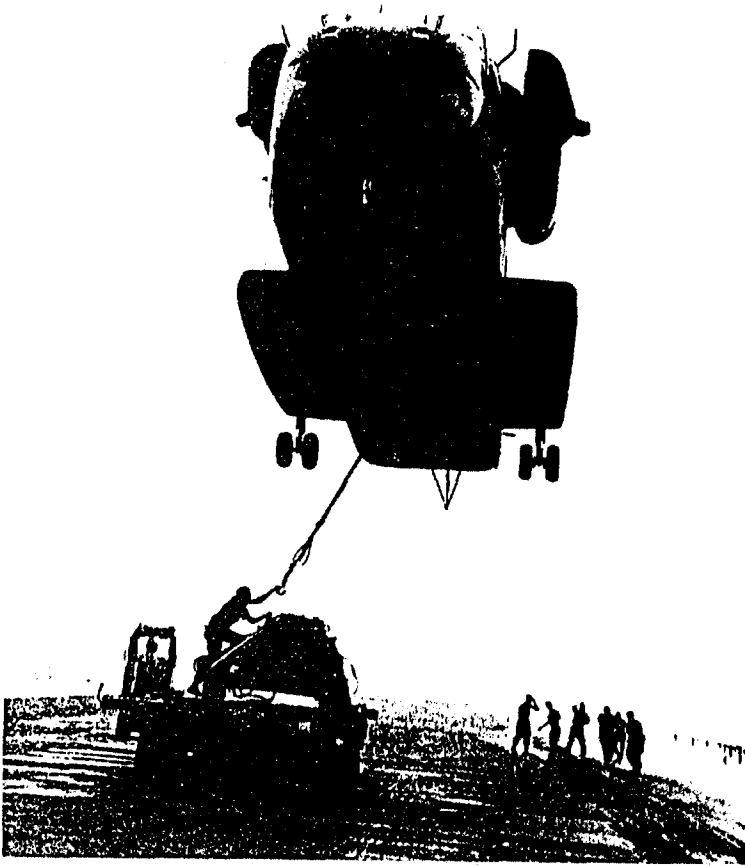

15. EXTERNAL TRANSPORTATION OF CARGO
UTILIZING THE NYLON FOUR POINT UNI-
VERSAL SLING

During the period the external transport method of lifting cargo has been utilized, it has proven to be a most effective means of carrying diverse

loads for distances up to 25 miles. However, a significant discrepancy in the materials used in the construction of the four point sling has been found. Seven external loads separated from CH-53A aircraft while in flight. The major contributing factor was failure of the nylon straps of the sling. The attachment points of the sling are metal to which the nylon straps are attached. The nylon strap rubbing against the metal attachment points wears quickly and decreases the effective longevity of the sling. It is imperative that all nylon slings be thoroughly inspected prior to their use. Each unit should institute a program of continued inspections of this sling to minimize the loss of cargo.

#

16. EMPLOYMENT OF CH-53 TO EMPLACE M4T6 BRIDGES

Recently an engineer battalion was tasked with repairing and/or replacing 18 bridges located throughout northern I CTZ. To comply with the time schedule, it was necessary to employ the CH-53. It was learned that the CH-53 is capable of lifting fixed spans of M4T6 bridging completely assembled from a rear assembly area to bridge sites and placing them directly upon prepared abutments.

#

17. ENEMY ACTION DURING TACTICAL AIR-CRAFT RECOVERY

The enemy has established a pattern of avoiding contact with the security force which is protecting a downed aircraft.

Friendly forces report the zone secure to recovery helos and escorts. As the recovery helo approaches to hover over the downed aircraft, the enemy emerges from hiding to direct intense fire at the recovery helo and security forces. After recovery is made, enemy fire is halted until retraction helos come into the zone to pick up the security force, at which time the helos and security force are again taken under fire.

#

18. TURBINE ENGINE LIMITATIONS

The preponderance of helicopter powerplants in the Marine Corps inventory has shifted from reciprocating to turbine-powered engines. The turbine-powered helicopters have self-governing features which automatically maintain rotor RPM. This automatic feature can cause a pilot to concentrate on the torque meter and neglect the remainder of the engine instruments. While flying in the atmospheric conditions encountered in the Republic of Vietnam, it is possible to stay within torque limitations and exceed the maximum engine temperature limit. Excessive engine temperatures

can result in engine failure or can cause premature removal of an engine for maintenance purposes. Engine failure can result in tragedy; an early engine transfer is costly in manpower, material, and time. The NATOPS flight manuals prescribe operating limitations for each helicopter. These limitations cannot be ignored. Detailed and close attention to all engine instruments in turbine-powered helicopters is mandatory. No single instrument can provide total reliability.

#

19. MONSOON TIPS--ROTARY WING

→ A diligent review of basic instruments, ADF, and TACAN procedures as well as GCA approaches should be emphasized for all pilots before and during the monsoon season.

→ Each unit should maintain a chart/photo that shows landmarks and obstructions in areas in which they operate.

→ During periods of heavy rain, the pitot-static system should be drained prior to each flight.

→ Ensure that bilge drainholes are free from debris and that bilges are drained frequently.

→ Review applicable NATOPS procedures.

#



20. USE OF UH-1E "SLICK" FOR EXTRACTIONS/ MEDEVAC MISSIONS

CH-46's attempting a recon extraction were driven away from the zone by intense enemy fire. The escorting UH-1E gun ships, however, were able to make repeated low altitude gun runs while drawing only sporadic fire. A CH-46 crewmember reported that the enemy pulled covers over their spider holes when fired upon. Machinegun rounds ricocheted off the covers.

The enemy took cover when the UH-1E gun ships attacked but risked exposure to fire on the more lucrative CH-46's. A UH-1E "Slick" finally extracted the remaining members of the recon

team. It is probable that the enemy felt the slick was another gun ship, thus providing the necessary time to make the pickup under minimum fire conditions. The low silhouette UH-1E "Slick" has its place in some extraction/medevac missions. If it is used only occasionally, it may confuse the enemy enough to make some extractions easier.

#

21. NIGHT EXTRACTION OF RECONNAISSANCE PATROLS

The following method for night extraction of reconnaissance patrols has been successful. When notified to extract, the pilot proceeds to the patrol's location and establishes radio communication with the patrol leader. The pilot identifies his aircraft by placing his position lights on the "flash bright" setting. Once aircraft identification is completed, the pilot requests the best landing direction into the pickup zone. If, for example, the direction is south, the pilot instructs the patrol leader as follows: "I am turning to a north heading and changing my lights to steady bright. On my command, give me a left or right turn until my aircraft is facing you. You can identify me as facing you when you see a rectangle of four lights: two green and two red. Stop my turn at that time and identify your position." When the patrol pickup point is identified, the aircraft descends immediately.

#

22. USE OF SMOKE FLARES DURING EMERGENCY NIGHT EXTRACTIONS

It has been found that strobe lights cannot readily be seen in the landing zone by helicopter pilots because the reflection of parachute flares from streams and rice paddies in close proximity to the pickup zone tend to flash much the same as the strobe light. Colored smoke flares have been tried for this purpose and found to be visible from the air even while parachute illumination flares are being used.

#

23. HELICOPTER LANDING ZONES

When operating in the field away from fixed fortifications, the selection of a landing zone within your perimeter is inviting enemy mortar, rocket and artillery fire. The enemy is able to obtain an excellent fix on your position by simply observing the flight pattern of the helicopters. Dependent upon the security forces available, terrain, observation and the length of time a unit will remain in a specified area, landing zones should be selected as far as practical from the perimeter or defensive position. The hundred or more meters gained by this deception may be the difference between enemy rounds landing in or out of your position.

#



24. CLEARANCE OF LANDING ZONES

During an operation conducted in dense forested terrain, combat engineers were heavily committed in clearing helicopter landing zones. To accomplish this clearing, engineers employed chain saws, axes, and demolitions. The following observations were made:

→ Chain saws, while too heavy to man pack for extended distances over rough terrain, proved effective for clearing smaller trees. The larger hardwood trees required axes and demolitions.

→ Standard demolition formulas did not provide sufficient explosives to fell the hardwood

trees which were found to require approximately twice the calculated amount.

→ Additional means should be made available to the engineers, other than heavy 5-gallon expeditionary cans, to transport gasoline and oil for the chain saws.

→ Extra chains should accompany the chain saws.

#

25. MAINTAINING HELICOPTER LZ's

The helicopter landing zone is more than merely another symbol on a tactical overlay. It's a fixed location for pilots to debark and embark troops and supplies. When ground units have been in an area for a length of time, there is a reluctance to clear and improve landing zones. Keep radio antennas and associated equipment and entrenchments well away from the LZ. Improve the LZ by expanding it where possible and clearing the approach and takeoff areas.

#

26. LANDING ZONE LIGHTING DURING NIGHT OR REDUCED VISIBILITY

An effective expedient has been found to illuminate helicopter landing zones when normal means

are not available. At each of the four corners of the landing zone a 106mm ammo box is sunk into the ground to its full length. During reduced visibility and/or rain, an M-49 trip flare dropped to the bottom of the ammo box produces a steady light directed skywards, which greatly assists the helicopter pilot in the final approach of the landing zone.

#

27. ENEMY "BAITING" AIRCRAFT TO LAND IN AMBUSH AREA

During an operation, a unit was airlifted into two landing zones. A short time later, an air observer saw several weapons lying in an open field in the general area of the landing zones but remote from the troops on the ground. Two aircraft were sent to pick up approximately 10 troops to recover the weapons. Landing in the field near the weapons, the two aircraft were brought under heavy fire. One aircraft was damaged and several casualties were incurred. The weapons had obviously been placed as bait for an ambush. When situations such as this are encountered, artillery and air support should be used to cover friendly activities.

#



28. EMPLOYMENT OF THE AN/TPQ-10 GROUND
RADAR WITH AUTOMATIC MODE OF THE
GROUND CONTROL BOMB SYSTEM (GCBS)

A VMA squadron attempted 37 GCBS target releases and identified the following problem. On each attempt by the ground station to automatically release the external stores, only one store from each station was released. This was true even with the Automatic Weapon Release System (AWRS) placed in the select mode of ripple salvo. An investigation revealed that the length of the ground

command release signal was less than the minimum safe interval of 70 milliseconds. This, therefore, eliminates the use of the AWRS in the select mode of ripple salvo or any ripple sequence.

If step releases are used, either manually or by AWRS, multiple ground signals must be emitted by the ground station. These repeated signals are necessary to provide the proper stepping sequence to the MER-7 rack. The MER-7 racks may be utilized with the automatic mode of GCBS by a salvo release; however, this procedure eliminates the capability to achieve optimum impact spacing on other than a point target.

#

29. SURVIVAL EQUIPMENT IN SV-2 VEST

A recent survey of aircrewmen in Southeast Asia disclosed that a majority carry 30 to 45 pounds of survival equipment on their person. This amount is in addition to the normal 33 pounds of equipment recommended by "Clothing and Survival Equipment Change No. 26." Most of this extra weight is stuffed into the SV-2 vest, creating the following serious disadvantages:

→ A heavy and cumbersome SV-2 survival vest can, when the aircrewman is seated, force the MK-3C life preserver down enough to hinder release of the lapbelt release fitting during emergency exit.

→ The additional weight can increase the possibility of back injury during ejection.

→ The added weight can greatly hinder a person attempting ground escape and evasion maneuvers.

The SV-2 survival vest should be packed in accordance with the guidelines set forth in "Clothing and Survival Equipment Change No. 26." The equipment specified therein, when used with imagination and initiative, is adequate to meet the requirements for survival, escape, and evasion.

#

30. COLORED PERSONNEL PARACHUTE CANOPY

A new personnel parachute canopy has been adopted with a distinct color pattern. The new canopy is divided into equal sections of orange, green, white, and sand colors. It is anticipated that the new colored chute will assist search and rescue aircraft in searches for downed airmen. A second advantage of the new chute will be in the differentiation of downed personnel parachutes from the parachutes used for flare or cargo drops. The new canopy with four color sections, will also make parachute panels available for camouflage or signaling purposes.

#

31. MIDAIR COLLISION CAUSES

A review of causes of midair collisions has revealed that one or more of the following factors are normally present before a collision:

- ➔ Breakdown in pilot/aircrew lookout doctrine.
- ➔ Poor technique in basic formation flying.
- ➔ Failure to adhere to briefed or established joinup and formation flying procedures.

During air combat operations, adequate briefings and complete understanding between concerned parties is mandatory. In formation flying, adherence to established or briefed joinup and formation procedures is essential. Pilot/aircrew lookout doctrine cannot be relaxed as long as the aircraft is moving on the ground or through the air. Events have shown that most midair collisions occur when there is little or no restriction to flight visibility.

All midair collisions are avoidable. The best means to avoid midair collisions is to use the best radar information available, maintain a sharp, continual visual lookout and comply with established procedures and - treat all airspace as if it were being occupied by more than one aircraft.

#

32. MAINTENANCE AND THE AIRCRAFT ACCIDENT RATE

All maintenance personnel are well aware of the impact that job performance has on the availability of the aircraft and the success of their unit. An aircraft that is properly maintained flies more hours, flies better and is less susceptible to disastrous mechanical failures than an aircraft which is being maintained on a casual basis. Additionally, a pilot who knows that his aircraft is being maintained by the book and has no deferred or "up gripes," has a greater degree of confidence in his aircraft and is less likely to be shaken by the unexpected.

Achieving this level of maintenance is a job for both the pilot and maintenance crew. The pilot must write his "gripes" thoroughly and then must follow up to find out exactly what was wrong and what was done to correct the discrepancies. The maintenance personnel must analyze their work and ensure that the total system is working properly.

Servicing or repairing an aircraft system is not a guessing game. Problem areas must be found and repaired "by the book." The pilot and maintenance crew, functioning as a team, can prevent the fatal consequences of an aircraft accident that occurs as a result of "casual" maintenance.

#

33. AERIAL PHOTOGRAPH REQUESTS

The units which follow the rules listed below are likely to receive quality photography in an expeditious manner:

- In addition to the desired scale, state the minimum scale acceptable.
- State the type of photographs desired and other types that can be utilized.
- Advise if film taken within a recent defined time period will suffice.

A factor which can cause delays in satisfying a request is the requesting unit's stipulation for one specific scale. Frequently a mission will be flown to satisfy a 1:5000 scale requirement and, due to factors such as AAA, small arms fire, terrain, etc., the aircraft will return with a scale of 1:7500 or higher. As far as the collection unit is concerned, this mission must be reflown as the specific request was not satisfied. A more realistic approach is to submit a requirement for the absolute minimum scale usable and also state what maximum scale could possibly be used. Timeliness is the essence in providing aerial photography. Any leeway allowed the photography unit will result in fewer unfilled requests.

Another factor that can assist in expediting completion of photo requests is the selection of the

type of photography desired. Frequently forward firing, oblique or stereo pairs can adequately satisfy a requirement. However, units frequently request only vertical pinpoints or vertical strips. Flexibility as to the type of photography desired will assist in the timely accomplishment of the request.

A final means of expediting photo requirements is flexibility in the date of the photography. Frequently, photographs of an area that may have been taken within a week or two weeks prior to the date requested are already available in the files. Often, these photographs will satisfy the requirements for area studies, landing zones, beach areas, etc.

#

34. EYES IN THE SKY

The terrain and vegetation in much of SVN places a limit on the effectiveness of ground surveillance. Airborne observers are an extra pair of eyes in the sky that can extend the area of observation. The AO's are trained to acquire current information on enemy activity, evaluate the terrain, adjust artillery and control airstrikes.

Radio nets are established to facilitate rapid reporting of the AO's observations to the commander on the ground or to strike aircraft on station.

In addition to providing ground units with aerial observation support, the AO is capable of providing frontline, lowlevel aerial photography. This type of photography can provide the requesting unit with a graphic portrayal of potential LZ's, ambush sites or danger areas.

An extra pair of eyes in the sky is available. Use them.

Chapter IV: COMMUNICATIONS

1. LVT COMMUNICATIONS

Supported units are seldom aware of the communications equipment installed in the amphibian tractor (LVT). All of the below-listed equipment is completely compatible with the FM radio equipment organic to the infantry battalion, and through advance coordination, much of this equipment can be made available for use by the supported unit.

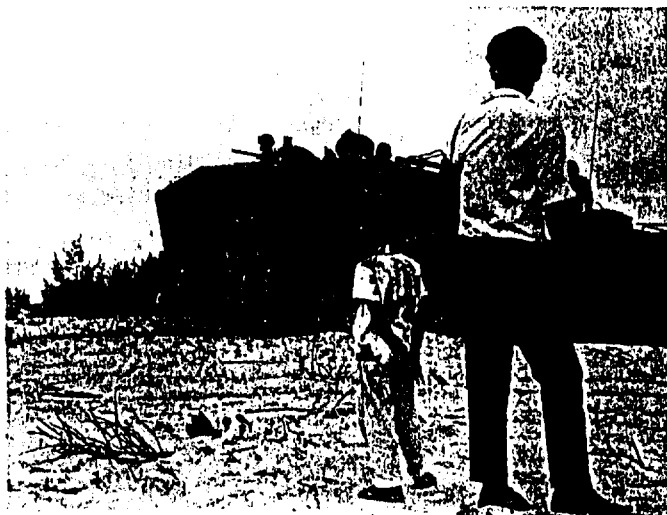

<u>RADIO</u>	<u>NO. PER LVT</u>	<u>NO. PER LVT (CMD)</u>
AN/VRC-44	1	1
AN/VRC-47	0	2
AN/VRC-53	0	2

The AN/VRC-44 radio consists of one RT-246 transceiver and two R-442 receivers.

The AN/VRC-47 radio consists of one RT-524 transceiver and one R-442 receiver.

The AN/VRC-53 radio consists of one RT-505 transceiver.

#

2. HF/SSB EQUIPMENT

The FM radio equipment has proved to be very reliable in the field. As a result, there is an occasional tendency to relegate HF/SSB equipment to the storage shelf. One unit, when faced with the necessity to use an HF/SSB piece of equipment, found that its operators were somewhat rusty in the radio's operation. Valuable time was wasted while rushed schooling was held to reacquaint radio operators with the proper procedures. Even though the PRC-25 can satisfy a high percentage of tactical radio requirements in SVN, it cannot fulfill requirements for which it was not intended. Training must be continuous to ensure that personnel can meet the requirements for a HF/SSB capability.

#

3. ULTRAHIGH FREQUENCY (UHF) ANTENNA AS-390/SRC

The AS-390/SRC antenna is used with the AN/GRC-48, AN/MRC-40/47/87 and LVTP-5 installed radio equipment.

It has been noted that a number of AS-390 antennas were installed with broken, missing, or improperly aligned counterpoise elements. Operation of this UHF antenna with a defective counterpoise assembly will result in a high standing wave ratio (SWR) which causes the RF power, intended for radiation, to be dissipated as heat due to an antenna impedance mismatch. This impedance mismatch is reflected back to the transmitter resulting in a reduced power output and a shorter power amplifier tube life. Properly adjusted and maintained antennas will improve communication

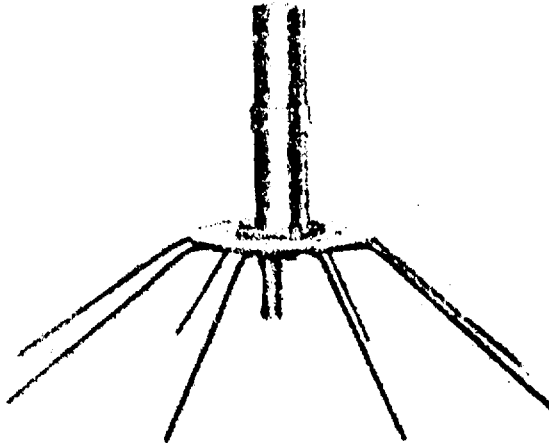

range, lessen maintenance problems and permit the radio to operate as designed. The following information is furnished to assist in providing proper support for the AS-390 antenna:

→ Counterpoise Assembly, FSN 5985-257-2627 is listed in SL-4-00765. The listed unit price for the assembly is \$16.90 and replacement is required when elements of the counterpoise are broken or missing.

→ Marine Corps Technical Instruction 00765-25/1 ch 1 provides information concerning construction of an antenna counterpoise element alignment gauge. Photographs are provided in the technical instruction to illustrate the proper method of alignment.

#

4. FM ANTENNA ALIGNMENT

Difficulty experienced in communications between III MAF and a subordinate command was determined to have been caused by faulty alignment of a new long periodic FM antenna. The outage occurred following strong winds which caused the antenna to point at a slight angle to the ground. When the technician arrived at the trouble site and adjusted the antenna array, leveling it with the ground, communications were immediately re-established.

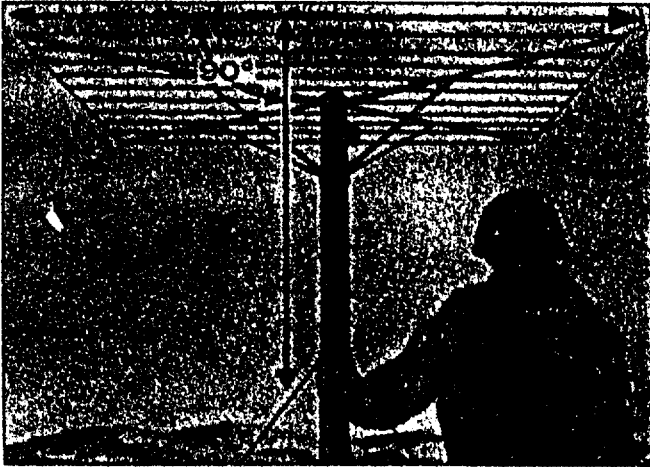

Radio operators should be instructed to inspect the antenna alignment vertically as well as horizontally, especially following strong winds or if an outage with a particular station occurs.

#

5. FIELD EXPEDIENT ANTENNA

Counterinsurgency operations frequently require dispersion of units over a large area, often in rugged terrain. Thus, communication becomes a major problem. At small unit level, the field expedient antenna is helpful. A 50-foot length of WD-1/TT wire suspended horizontally serves as a directional line-of-sight antenna. Coupled with a 600-ohm resistor, this antenna will provide even greater selectivity.

#

6. INCREASE VEHICULAR RADIO RANGE

A vehicular radio comes equipped with a built-in counterpoise, which is the vehicle itself. To use the built-in counterpoise to best advantage, orient the vehicle to get the greatest mass of the vehicle between the antenna and the distant station. If the antenna is mounted on the left rear of the vehicle, orient the vehicle so that the right front fender is pointing toward the distant station. Proper vehicle orientation will improve both the signal strength and its quality.

#

7. MAINTENANCE OF COMM/ELECT EQUIPMENT

The maintenance of communication/electronics equipment can be enhanced by the effective use of

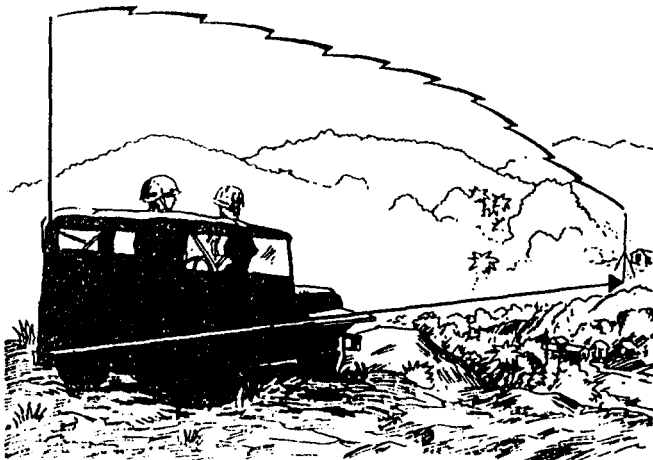

the below-listed items which are available in the supply system. These items are used to help reduce corrosion and rust on exposed metal surfaces and electrical connectors:

→ Sealing and Insulating Compound FSN 5970-159-1598. This is a sealing and insulating compound which increases the water tight integrity of connectors and will reduce corrosion and equipment failures when applied to external electrical connectors.

→ Rust and Corrosion Inhibitor FSN 6850-960-0308 (12-oz. aerosol can). The application of this inhibitor to exposed metal reduces the effect of rust and corrosion.

#

8. PREVENTIVE MAINTENANCE OF THE ANTENNA ELEMENTS AT-1095 AND AT-1096/AN/MRC-109

It has been noted that during prolonged periods of time, 2 weeks or longer, between the erection and breakdown of the antenna sections, AT-1095 and 1096, that they tend to freeze together. Where radio set AN/MRC-109 cannot be P.M.'d by communication personnel, the driver of the vehicle can prevent freezing of the antenna sections by an application of brake fluid. Unlike oil, brake fluid will not decrease signal output. The preventive

maintenance steps listed below will assist in eliminating the problem:

- Break down all antenna elements daily when radio is not in use.
- Wipe the antenna free of all dust, dirt, and grime.
- Apply brake fluid to the connecting parts of the antenna to prevent freezing.

#

9. RADIO SET AN/MRC-83

An increasing number of radio sets AN/MRC-83 are being deadlined due to broken studs on the 28 volt D.C. terminal board. From an examination of the break, it appears that the breakage is caused by excessive torque being applied while tightening the 28 VDC line to the power supply. Personnel tightening the power leads should be cautioned against the use of excessive force.

#

10. RADIO SET AN/TRC-75

When operating the Radio Set AN/TRC-75, excessive reflected power frequently results in burned components; particularly the Antenna Coupler (CU-749) and Transmitter (T-730). When

operating radio sets, AN/TRC-75, AN/MRC-83, AN/MRC-87 and Communications Central AN/TSC-15, the RF power meter must be maintained in the reflected power position. This position will provide the operator a visual indication that a possible fault exists in the equipment or the antenna system.

If the reflected power meter reading exceeds twenty watts when the set is in operation, the antenna must be reloaded. If, after reloading, the reflected power still exceeds twenty watts, the procedures below should be followed:

→ Turn the set off and check all antenna connections. If all antenna connections are tight, attempt to reload the set.

→ If the reflected power is still excessive, turn the set off and call for a technician.

#

11. AN/PRC-49C EMERGENCY RADIOS

Some AN/PRC-49C emergency radios have come "on the air" and transmitted emergency-beacon signals even though the lanyard assembly, which should prevent this, has been properly installed. It has not been possible to turn these radios off except by removing the batteries. Preliminary investigation indicated that this trouble may be caused by a loosening of the screws which

hold the lanyard assembly retaining bracket to the radio's case. It has been suggested that Loctite be used to keep these screws tightened. The undesired transmission may also be attributed to the inability of the spring, mounted under the power switch lever arm, to adequately depress the ON-OFF switch.

#

12. PROTECT HELMET RADIO CORDS

Helmet radios have frequently been put out of commission because the switch cord has been torn from the receiver pod (fig. 4-1).

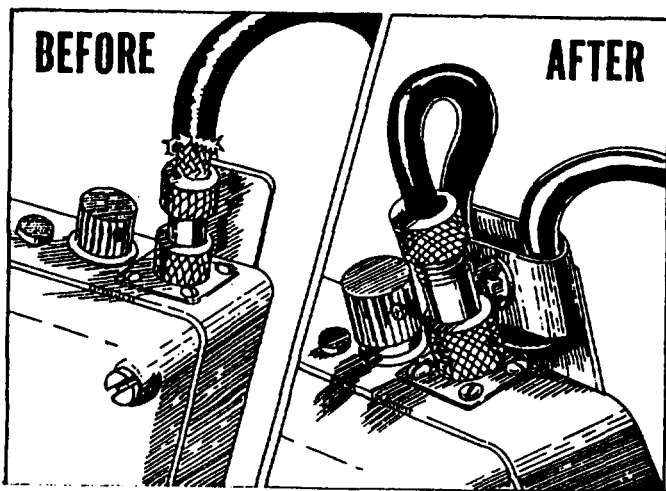

Figure 4-1

This failure of the helmet radio (RTG-223), is caused by repeated downward pulls on the hand switch. The installation of a simple clamp, as shown below, prevents stress on the switch cord and will prevent helmet radio failures.

#

13. EXTEND EQUIPMENT LIFE

When batteries are left in radio equipment, the result is often damage to the radio from expansion and corrosion of the batteries. When communication equipment is not to be used for a day or more, remove the batteries and clean and dry the inside of the battery case.

#

14. RADIO HANDSETS

The H-33/PT Handsets (fig. 4-2) supplied for use with the AN/PRC-47 and AN/TRC-75 radios should be modified by the connection of a .02 mfd capacitor across the terminals of the handset mouthpiece. This capacitor precludes audio distortion from being introduced during transmissions. The H-33/PT Handsets supplied for use with other radio equipment do not require this modification.

Using units should examine their H-33/PT Handsets in order to determine which H-33/PT's have the required modification. The handsets may

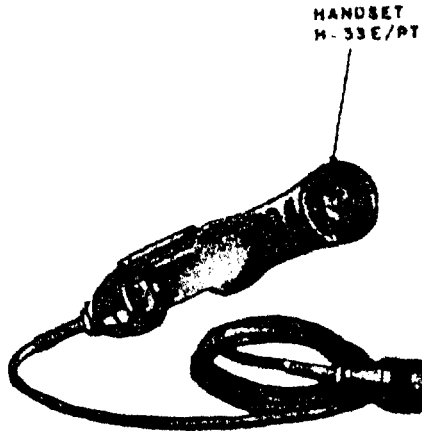

Figure 4-2

be examined by simply unscrewing the mouthpiece and removing the small mike element. If the handset has the required modification, the small .02 mfd capacitor should be readily apparent between the two mike element terminals. If the handset has the capacitor installed it should be marked accordingly.

#

15. HANDSET H-138

The thin plastic membrane over the mouth and earpieces is easily broken. Moisture within the

mouth or earpiece can lead to transmission and reception difficulties. To provide better protection, the plastic protective bag of the BA-386 battery can be placed over the entire handset and taped at the open end.

If the H-138 handset does not function properly, try cleaning the contacts on the receiver-transmitter connector and the connector on the handset with a pencil eraser. Often this will save a trip to the communication shop.

#

16. CABLE BRACKET FOR USE ON CONCRETE POWER POLES

In SVN, joint-use specifications require that communications cable be installed at a specific



height above the ground. This has resulted in the requirement for a cable bracket, since holes are not authorized to be drilled in concrete poles (fig. 4-3).

A practical and efficient cable bracket can be fabricated from three-bolt clamps and a length of 6m messenger cable of sufficient length to wrap around the pole. The poles presently being used are tapered, thus preventing slippage of the messenger and bracket.

#

17. OVERHEAD CABLE WITH FIELD WIRE WD 1/PT

A wireman is taught to use a basket weave knot overheading cable with field wire WD1/PT (fig. 4-4).

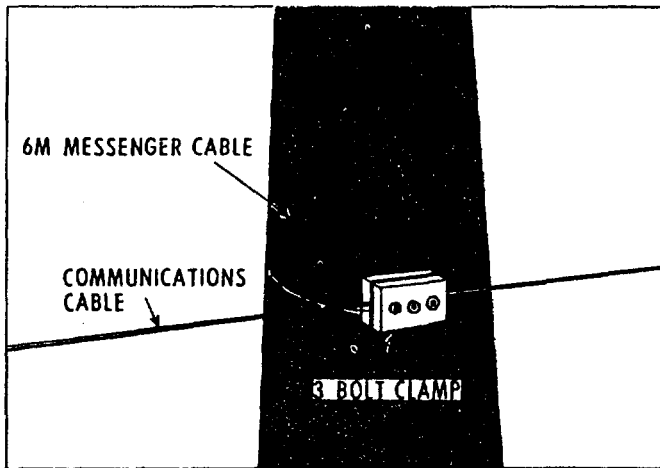

Figure 4-3

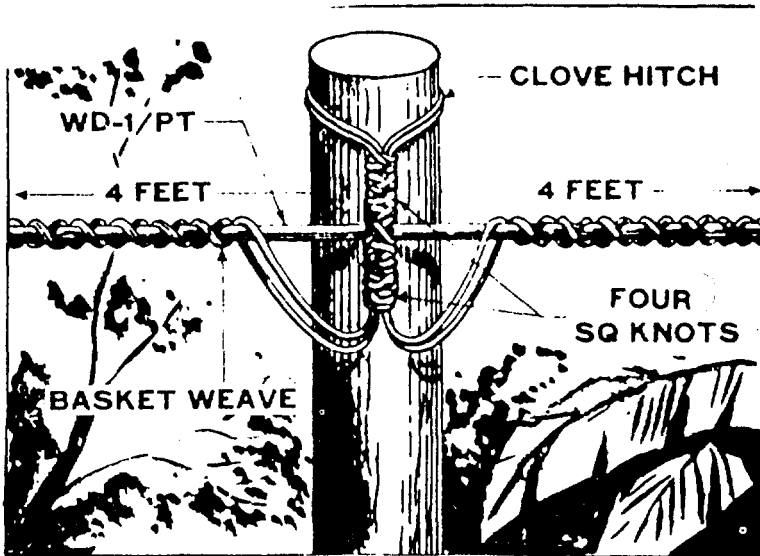

Figure 4-4

This technique can be improved by adding square knots and a clove hitch tie to the basic basket weave knot. The end result is a rigging which decreases cable slack by at least 20 percent, extends cable life by approximately 25 percent and increases the strength of the cable considerably.

The procedure for improving the cable tie is to double the slash wire prior to tying a clove hitch to the pole, tie four square knots next to the clove hitch and secure the cable by using four additional square knots. The increased strength of the cable tie permits the Marine on the ground to use his full weight to tighten the cable, without fear of

slippage or breakage of the tie. When the tie is sufficiently taut, the normal basket weave knot is extended approximately 4 feet on either side of the tie to distribute the cable weight over a longer length of cable.

This method of tying overhead cable will prevent unnecessary cable fraying, extend the life of the cable and reduce the number of trouble calls required to ensure uninterrupted communications.

#

18. REMOTING RADIOS OVER LONG DISTANCE UTILIZING AN/PRC-25, AN/TRC-27/B AND AN/GRA-39 RADIO EQUIPMENTS

The maximum distance a radio can be successfully remotored using wire lines is 2 miles. A multiplexed wire-radio shot was used to remote three radio sets, AN/PRC-25, from Camp Evans to HILL 674, a distance of 7 1/2 miles over difficult terrain. Radio checks were made from Camp Evans to Dong Ha, Khe Sanh, Con Thien, and Danang. Seven radio stations can be remotored up to 10 miles over each radio relay shot (fig. 4-5).

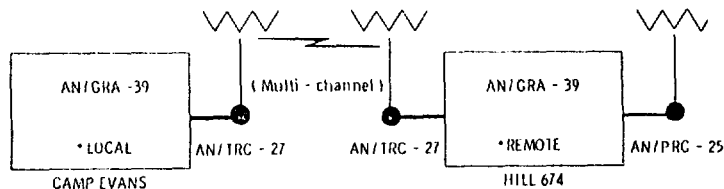

* One per radio circuit - up to seven

Figure 4-5

The radio relay terminal, AN/TRC-27/B, requires precise adjustment of the modulation and output levels of the multiplexer, TD-101/B. Inasmuch as these settings are lower than normal, each Radio Relay Terminal TD-101/B must be adjusted to the level required to operate the radio terminal and not to the normal level determined by the AN/TRC-27/B terminal operator. This adjustment of the TD-101/B is critical and placing a monitor AN/PRC-25 at the AN/GRC-39 local position (on the same operating frequency) will assist the adjusting procedure.

The multiplexed wire-radio remote system is a substitute for the retransmission cable MK-456/G, which often is unsatisfactory. It further provides the capability to remote seven radio stations from a forward position over intervening terrain.

#

19. REMOTING THE AN/PRC-25 WITH THE AN/GRA-39

When remoting the PRC-25 with the AN/GRA-39 radio set control group, frequently a butterfly effect results as the volume on the remote unit of the GRA-39 is increased. This volume can key the radio transmitter. To prevent this from happening, connect the control group to the radio set and turn the volume switch of the PRC-25 to the No. 4 dot position. Then, turn the volume up on the remote unit of the GRA-39.

#

20. FIELD EXPEDIENT FIVE-DROP SWITCHBOARD

It is often desirable to have landline communications while deployed in a defensive position during prolonged periods in the field. The weight of normal switchboard equipment makes it almost prohibitive to use.

A lightweight switchboard can be constructed (fig. 4-6) prior to going to the field and, complete with six TA-1 sound powered phones, can easily be carried. Construct as follows: Solder a short (10"-12") piece of two-circuit wire into the ring/ audio plug of each of the five TA-222 switchboard line-packs, and place the five TA-222's in an MX-230A/PT accessory kit. Next, strip the end of a TA-222 cord opposite the jack and place the stripped end in the line-jack of a TA-1, for use by the operator. For operation, twist the desired landlines to the short wires on the rear of each

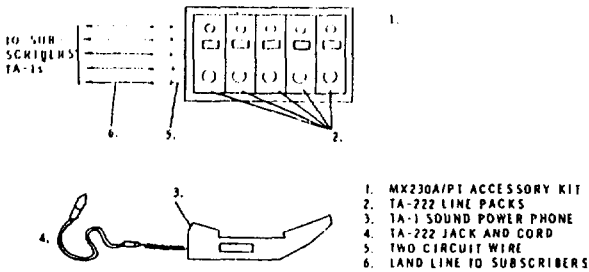

Figure 4-6

TA-222. The switchboard is signaled by the white drop.

#

21. SWITCHBOARD SOUNDPROOFING

The need to improve switchboard operations within Vietnam has been given continued attention at all levels of command. Having a soundproof switchboard room is one means to improve the switching of calls by lessening the noises of aircraft, generators, vehicles, etc. The walls and ceiling of the switchboard room can be covered with pieces of styrofoam material. Styrofoam material may be obtained at ordnance/bomb dump areas from discarded fuse and flare packaging material. Switchboard operations have been improved considerably by utilizing this method of soundproofing.

#



Chapter V: LOGISTICS

1. WHEELED VEHICLES

Speed limits are a guide to the maximum safe speed which can normally be used. When conditions are other than normal, speeds must be adjusted downward to whatever limits can be safely maintained under existing conditions.



Conditions that require lowering of speeds are:

Reduced visibility - Anything that limits vision, such as rain, fog, or dust.

Reduced traction - Anything which reduces traction or affects braking and steering. Examples

are potholes, washboard surface, mud, rain and standing water.

Reduced clearance - Anything which reduces the width and maneuvering room of the road. Erosion of shoulders, presence of other vehicles, troops or civilians along the road are examples of reduced clearances.

Reduced response - Anything that will affect the individual operator's ability to respond to rapidly changing situations. Fatigue and medication are factors which affect a driver's responsiveness.

The judicious driver will adjust his speed according to changing conditions.

#

2. TAILGATING

From boot camp to Vietnam the word is - DON'T BUNCH UP. When Marines hear this term they usually think of incoming artillery or mortars, a mine, or a boobytrap emplacement. When you operate a vehicle, keep the same phrase in mind - DON'T BUNCH UP. Tailgating is a major cause of motor vehicle accidents. Maintain a safe distance between vehicles.

#

3. MULTIFUEL VEHICLE OPERATING TIPS

Starting

→ Do not operate the starter continuously for more than 10 seconds. If a vehicle does not start immediately, allow a two-minute rest period before attempting another start.

Descending Steep Grades

→ It is important to slow the vehicle's speed when descending a steep grade. All drivers learn this after going down their first steep grade.

→ Follow normal driving habits; go down the hill in the same gear or one gear lower than that required to climb the hill.

→ When down shifting, engine RPM must be reduced to the proper RPM by use of the service brakes.

→ The proper selection of transmission gears will enable the engine to be used to retard the vehicle speed on downhill grades.

→ The down shifting must be in order; fifth to fourth to third to second to first.

Shutdown

→ Shutdown of the engine for periods of 30 minutes or less (rest stops, loading and unloading

cargo) is NOT recommended. When the engine is to be shut down for lengthy stops, it is mandatory that it be cooled by idling for a period of 5 minutes.

#

4. TWO AND ONE-HALF TON MULTIFUEL TRUCK CLUTCH ROD

During the weekly preventive maintenance operations, one of the items to check on the 2½-ton multifuel truck is the amount of free travel in the clutch pedal. There should be 1½ to 2 inches free pedal travel. If this free travel is not evident, or there is difficulty in adjusting the pedal, a short clutch control rod may be causing the trouble. Some control rods have been found with more than an inch missing from the threaded end. The control rod, measured in a straight line through the threaded end, should be exactly 13 inches in length from the threaded end to the center of the holes at the fixed-yoke end.

Careful periodic checks are required to ensure that the locking hardware for the clutch adjustment rod lever is secured properly. This hardware, consisting of a nut, a bolt and a lockwasher, can be shaken loose by vehicular vibrations resulting from driving over rough terrain. Loose locking hardware will allow the clutch adjustment rod lever to rotate on the splined throwout lever shaft, thereby causing improper free travel in the clutch pedal.

Short rods should be replaced by new ones. The proper designation of a new rod is Rod, Control W/Yoke Assy, FSN 2540-752-0977. If the control rod is the proper length and there is difficulty in setting the correct free travel, check the clutch linkage. If the release bearing and bearing sleeve do not work freely, they should be disassembled and lubricated by direct support maintenance personnel.

#

5. FUEL LINES ON THE M-54 TRUCK

The fuel line from the gas tank to the fuel filter on the M-54 truck has been rupturing, causing engine failure. Close scrutiny revealed "cracks" in the fuel line either at the gas tank

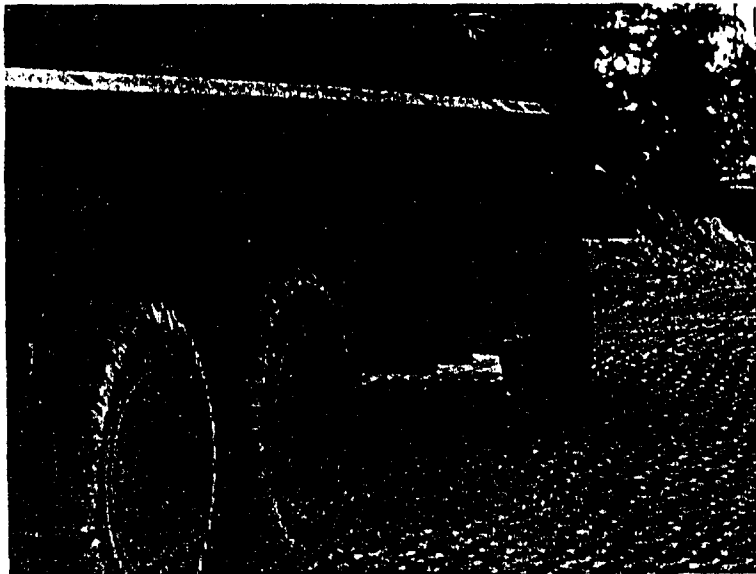

fitting or the first securing point of line to the frame. A field expedient can be accomplished by inserting a seamless copper tube, cold drawn, with a soft concealed "loop", between the fuel tank and the frame.

#

6. STARTER SWITCHES

The starter switch used on the M38A1, M422A1 and M37B1 vehicles builds up carbon deposits to such an extent that the starter switch develops a short which in turn causes the batteries to become discharged.

The problem can be minimized by testing and cleaning the starter switch during the quarterly preventive maintenance service. Testing of the starter switch utilizing a low-voltage circuit tester should be accomplished in the following manner:

- Disconnect the ground cable at the battery.
- Disconnect the battery starter cable at the starter.
- Connect the low-voltage circuit tester to starter circuit.
- Connect ground cable at battery.
- Read voltmeter on tester.

(1) A reading of .2 volts or less is satisfactory.

(2) A reading above .2 is unsatisfactory and the switch must be repaired or replaced.

(3) Any echelon of maintenance above first is authorized to repair a damaged starter switch.

#

7. WRECKER OPERATIONS

Leaking seals in the boom hydraulic system of the M-543/M-543A2 wreckers should be checked promptly by a mechanic. Undersize or cracked compression cups usually cause these leaks. There are four cups in the elevating cylinder and the extension cylinder assembly, and they must be the right size--4.970 to 4.990 inches in diameter. Any cup which varies from these specifications will not withstand the hydraulic pressure which builds up in the boom system during operation. The proper FSN of this compression cup is 2590-523-4305.

#

8. DEADLY CARBON MONOXIDE

Carbon monoxide is a colorless, odorless, deadly poisonous gas, which, when breathed, deprives the body of oxygen and causes suffocation. Exposure to air contaminated with carbon monoxide produces symptoms of headache, dizziness, loss of muscular control, apparent drowsiness and finally, coma. Permanent brain damage or death can result from severe exposure.

The gas occurs in the exhaust fumes of fuel-burning heaters and internal-combustion engines and becomes dangerously concentrated under conditions of inadequate ventilation. The following precautions must always be observed to ensure the safety of personnel whenever the personnel heater, the main engine or the auxiliary engine of any vehicle is operated for maintenance or tactical purposes:

→ Do not operate heater or engine of vehicle in an enclosed area unless it is adequately ventilated.

→ Do not drive any vehicle with inspection plates, cover plates, or engine compartment doors removed, unless necessary for maintenance purposes.

→ Ensure that personnel riding on vehicles that vent carbon monoxide through an upper hatch are aware of the danger of carbon monoxide inhalation.

→ Be alert at all times during vehicle operation for exhaust odors and exposure symptoms. If either are present, immediately ventilate personnel compartments. If symptoms persist, remove affected personnel from vehicle and treat as follows: Expose to fresh air; keep warm; do not permit physical exercise; if necessary, administer artificial respiration.

#

9. TIPS FOR DIESEL FUEL USERS

All diesel fuel contains some water. The water in diesel fuel can cause corrosion, damage fuel injection pumps, and clog the fuel system. Here are a few tips for preventing problems with diesel fuel:

- Drain diesel fuel filters daily - twice a day during the summer months.
- Drain the water from the bottom of the fuel tank when the vehicle is secured for the day.
- Top off the fuel tank when the vehicle is secured for the day.
- Keep all connections closed tightly on fuel drums.
- Do not move fuel drums unnecessarily.

#

10. TOWING THE M-151 JEEP

It has been found that the lifting shackles of the M-151 Jeep are being bent as a result of improper towing. The tow chain is being placed through both lifting shackles utilizing one chain; thus, when pressure is applied to the tow chain, the lifting shackles bend inward.

IMPROPER TOWING OF THE M-151

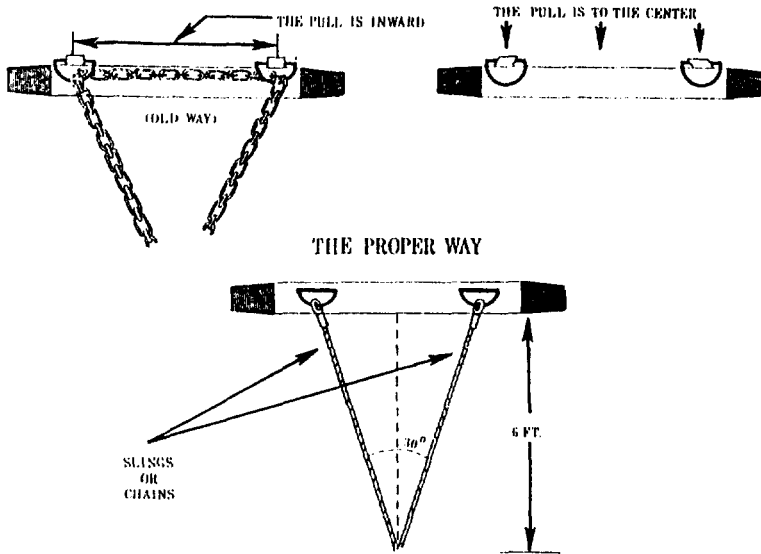

Figure 5-1

This problem can be alleviated by utilizing two chains as shown in figure 5-1. For additional information relative to towing the M-151 Jeep, consult TM 9-2320-218-10 and FM 20-22.

#

11. M-151 HINTS

The Utility Truck, 1/4-ton, 4x4, M-151 will replace both the M38A1 (Jeep) and the M422 (Mighty Mite). Below are a few operation tips:

→ Operators should be cautioned that the M-151 is more susceptible to overturning than its

predecessors. Speed should always be reduced when making a turn or going around a curve.



→ Some models of the M-151 have an emergency brake that can be released by tilting the driver's seat forward. To prevent accidental movement of your vehicle, always park in gear and/or chock the wheels.

→ Rear suspension arm bushings are not interchangeable between M-151 and M-151A1 vehicles. However, the complete rear suspension assembly is and can be interchanged with earlier model vehicles.

→ Plan on high usage of shock absorbers and order advance replacements accordingly.

→ If there is a complaint about "insufficient gas," mechanics should check the two components of the fuel system that have a direct bearing on proper operation of the fuel pump: the filter on the bottom of the electric fuel pump, and the fuel pump safety switch. The filter on the bottom of the fuel pump is a replaceable cylinder of helically wound ribbons of cellulose. Impurities in the fuel are deposited on the entrance edges of the ribbon where they can be easily cleaned off without damage to the filter element. Should the engine stop due to insufficient fuel, it is probable that the filter has become clogged with sediment and will not allow fuel to enter the fuel pump. The filter should be checked and cleaned or replaced, as required.

#

12. PROTECTION FOR THE MAIN CABLE FROM THE XENON LIGHT TO THE GUN TURRET

The exposed length of cable which runs from the Xenon light mounted on the 90mm gun on the M48A3 tank is often damaged by personnel inadvertently tripping on it or by being snarled and broken by heavy foliage.

Four sandbags evenly placed on the cable after it has been coiled in an S-shape serve to hold the cable close to the turret and still allow the maximum and minimum elevation and depression of the 90mm gun. The sandbags prevent the cable from

hanging loosely and also protect it from tankers scrambling over the turret during battle stations.

#

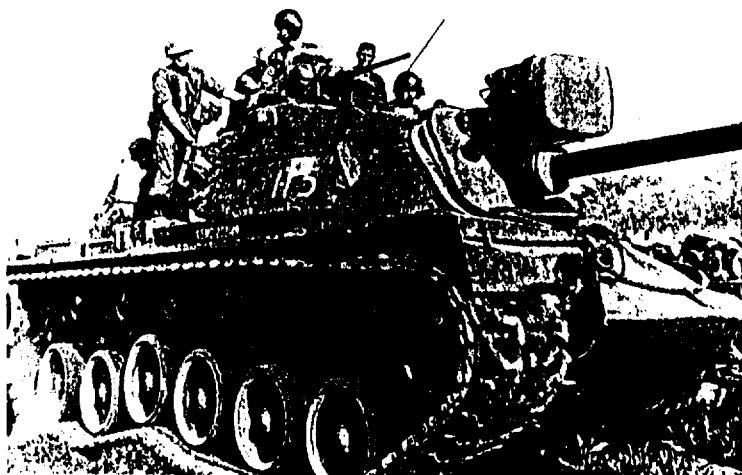

13. M48A3 TANK

Reports have indicated that some organizational turret mechanics in SVN have been throwing away unserviceable end housing assemblies when they replace the M17B1C rangefinder on an M48A3 tank. The housing assemblies should not be thrown away even if unserviceable.

TM 9-2350-224-20P (May 63) is in error in that it shows no recovery code for the end housings. The new TM 9-2350-224-25P (Jan 66) supersedes the May 63 TM and the end housings are now shown with a recovery code.

Unservicable housing assembly ends, FSN 1240-346-8071, should be returned to the Marine Corps supply centers for repair. These housings cost about \$400 each and are not expendable.

If you are in the habit of throwing them away - Stop! Get them back in the supply system.

#

14. M48A3 CUPOLA JAMMING

Problems of cupola jamming have been reported on M48 tanks equipped with the new vision ring. The cupola jamming has occurred when expended brass from the .50 caliber machinegun drops into the water gutter of the vision ring or into the right cupola lifting eye. The construction of a small chute or slide will allow the expended brass to bypass the water gutter; a strip of tape placed over the cupola lifting eye will prevent brass from falling in the lifting eye.

#

15. TOWCABLE FOR TANK SECTION

On many occasions, tracked vehicles become bogged down in terrain which precludes the use of a 10-foot towcable in recovery operations. The use of a number of the 10-foot towcables fastened together is one solution but requires considerable time to rig and is dependent upon availability of a number of extra tow hooks to fasten the towcables together.

A 50-foot towcable carried by each tank section will speed recovery operations and reduce the chances of additional tanks becoming bogged down.

#

16. M-110 GAS CHECK PADS

Recent reports have indicated that the wrong gas check pad is being used on the Howitzer, Self-Propelled, Full Tracked, 8", M-110. The use of an improper gas check pad can cause gas blowback when the weapon is fired. Two different gas check pads are marked for use on the M-110. One pad is marked for use with the M-107 (175mm gun) and the M-110. While this pad is marked for use in both weapons it should not, repeat not, be used with the 8" howitzer, M-110. The only gas check pad that should be used is listed as FSN 1030-620-6498 and marked specifically for the M-110.

#

17. FOR LACK OF A. . . .

For lack of a grease seal a truck was deadlined. For lack of a truck, 100 rounds of ammo were not transported. For lack of ammo, an artillery battery could not fire. For lack of fire support, a fire team could not maneuver. For lack of maneuver, a Marine died. . . . For lack of a grease seal, a Marine died.

When the "little things" are done properly, the "big things" will fall in place. The big picture is painted by individual responsibility. Be sure you take care of your individual responsibilities as expected of a Marine.

#

18. FIRE CONTROL EQUIPMENT PM'S

Fire control instruments include mechanical, optical, electrical and electronic components varying from a simple wrench-type fuze setter, to highly complex and integrated fire control systems. They are generally rugged and suited for the purpose for which they have been designed. However, they will not withstand rough handling or abuse. Inaccuracies and malfunctions are the inevitable result of maltreatment.

Here are some rules to observe when handling fire control instruments:

DON'T

- Turn screws or other parts not pertinent to employment of the instrument.
- Force the rotation of any knob beyond the stop limit.
- Point a telescope directly at the sun.
- Tighten leveling and clamping screws beyond a snug contact.



DO

- Keep the instruments as dry as possible. If an instrument is wet, dry it carefully before placing it in its carrying case.
- Keep the instruments in the carrying cases provided, or covered and protected from dust and moisture.

→ Apply oil sparingly when operating in sandy or dusty areas.

→ Adhere to prescribed organizational lubrication maintenance.

Whenever there is evidence of corrosion or gummy deposits resulting from congealed oil, clean the exposed surfaces with drycleaning solvent or volatile mineral spirits paint thinner, wipe thoroughly dry, and apply a light film of oil.

Perspiration from the hands is a contributing factor to rust. After handling, instruments should be wiped dry and a light film of oil should be applied to all metal parts.

To remove dust from optical components, brush the glass lightly with a clean camel's-hair artist brush and rap the brush handle against a hard body to knock out the small particles of dust that cling to the hairs. Repeat this operation until all dust is removed.

To remove oil or grease from optical components, apply liquid lens cleaning soap with a tuft of lens tissue paper and wipe gently with clean lens tissue paper. If liquid soap is not available, breathe heavily on the glass and wipe with clean lens tissue paper.

Batteries should be removed when not in use. When batteries are dead, a chemical reaction occurs and the acid produced will damage the battery tube.

Fire control instruments are important items of equipment. Keep them effective by properly maintaining them.

#

19. METASCOPE PM'S

The metascope is a small lightweight device which is used for observation during the hours of darkness. The Image Metascope, Type T-5, can receive infrared light from a source several miles away and has a built-in infrared light source which will project a beam of infrared light to a distance of 50 meters. When using the image metascope, everything within the range of the projected light beam can be seen, enabling the viewer to actually see in the dark.

Care must be taken when installing the BA 1312 mercury battery in the metascope. The metascope switch assembly is equipped with a spring to hold the battery firmly in place within the receiver battery housing. The housing is made of light aluminum and threads can be stripped easily. If adequate pressure is not maintained on the spring when inserting the battery, the switch assembly may extend out a sufficient distance to strip the aluminum threads of the housing. Use additional care when changing mercury batteries in the metascope. Don't allow a valuable night observation device to be out of action because of haste or carelessness.

#

20. TRAILERS

Trailers require the same preventive maintenance procedures as do vehicles. The tires, wiring, lube, paint and brakes must be serviced. Trailers with air over hydraulic brake systems (1½ ton and above) have an air line filter that requires regular cleaning. Open trailers with floor drains should be parked with the drains open to allow rain to run out. The drains should be inspected to ensure that they have not become clogged. Those trailers without drains should be parked with the tailgate down so that water will run out when proper pitch/inclination is provided.

#

21. AIR CLEANERS REQUIRE DAILY INSPECTION

Reports have been received from using units stating that considerable difficulty has been encountered with the air cleaners of the EIMCO tractors being used in RVN.

TM 04471A-15 specifies that the EIMCO tractor air cleaner will be changed whenever the air filter indicator on the instrument panel registers in the red when the engine is running. However, operating conditions in Vietnam are such that air cleaners should be inspected daily. When operating under extremely dusty conditions, hourly inspections should be the rule. The air filter should be changed



when the visual evidence shows that a change is necessary, rather than dependence upon the air filter indicator on the instrument panel.

#

22. HYDRAULIC FAILURES ON THE TRACTOR, TD-15

Hydraulic failures on the Tractor TD-15 may be caused by ruptured seals in the hydraulic system, untimely replacement of the filter and improper cleaning of the strainer element. To limit these "breakdowns," replace the filter after every 50 hours of operation and ensure that the strainer element is cleaned simultaneously with replacement of the filter. Failure to accomplish this preventive maintenance on a regular basis increases

the possibility that the filter will breakdown, causing the strainer element to clog up, thereby restricting the flow of oil to the pump.

#

23. GENERATORS

Listed below are a few basic operating and inspection tips for all generator users. The applicable technical manual for a particular generator should be consulted for detailed assistance.

→ All generators, regardless of size, require daily attention.

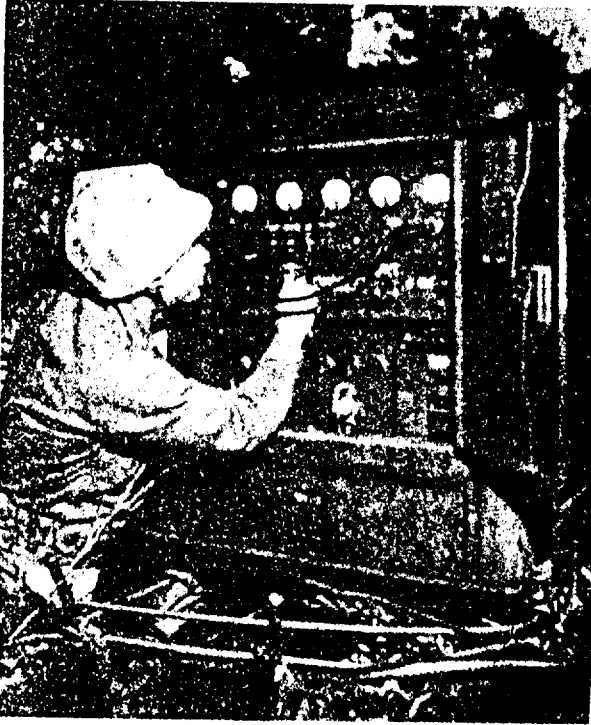

- All generators must be level to operate properly. If sited on soft ground, mud, sand, etc., use a plank or log for a foundation.
- Keep rain off the generator; use a tarpaulin or construct a shelter.
- Do not block the exhaust stack of any generator.
- Ensure the generator is properly grounded.
- Ensure that the radiator is clean, the radiator hose is in good condition, and the coolant is at the proper level.
- Check the fan belt to ensure that it is properly adjusted.
- Check the battery connections, oil filter, and water level.

#

24. BATTERY CARE

The proper amount of an electrolyte solution must be maintained in wet-cell batteries to receive optimum performance. Maintenance personnel should ensure that electrolyte used in tropical climates does not exceed 1.200-1.225 specific gravity. TM 9-6140-200-15 provides the proper procedures to be followed to obtain the correct

specific levels. Batteries containing a tropical electrolyte solution should be identified with a 1-inch-white dot near the positive (+) post. Remember to match batteries--not more than 25 points specific gravity or .02 volts difference. Remember to keep batteries, compartments and all hardware clean and free of corrosion. The use of baking soda and water to clean batteries will help to eliminate corrosion, but not forever--Keep checking.

#

25. FIELD EXPEDIENT RIFLE CLEANING ROD

Replacement cleaning rods for the M-16 have been extremely difficult to obtain. A satisfactory field expedient replacement is a 1-meter length of strong, thin wire (the wire from an electric blasting cap is suitable). The cleaning patch is secured in the center of the wire by one or two turns, and the wire threaded through the barrel. Sticks can then be attached to each end of the

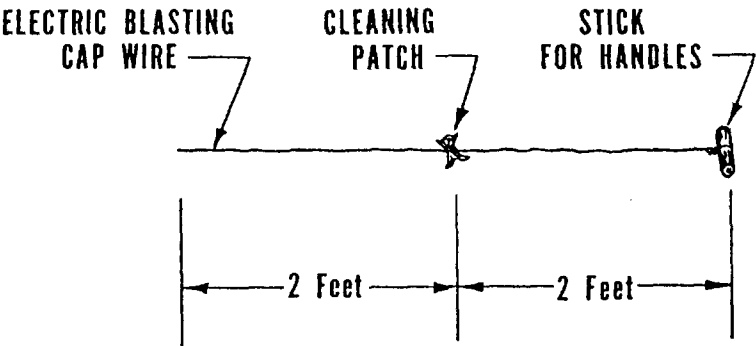

wire as handgrips for drawing the patch back and forth. The wire is easy to carry when not in use.

#

26. DRAIN BEFORE SHOOTING

During operations that require fording streams or traversing flooded rice paddies, it is possible that the M16A1 rifle barrel will be filled with water. Pointing the muzzle down and letting the water drain out is not the complete solution. The surface tension of the water combined with the small bore of the M16A1 makes it difficult for water to run out freely. If any amount of water blocks the bore when the weapon is fired, the pressure buildup could split the barrel and injure the shooter. To prevent injuries and split barrels, follow the steps shown below when water has flooded the barrel of the M16A1:

- Point the muzzle down.
- Pull the charging handle to the rear a short distance so that air can enter the barrel and allow the water to drain out.
- Press the forward assist to ensure that a round is seated in the chamber and the bolt is locked.

#

27. AK-47 ASSAULT RIFLE

OPERATING INSTRUCTIONS

- Load the AK-47 magazine by placing a cartridge on the magazine between the feed lips and pressing the cartridge down into the magazine. Repeat until the magazine is full (30 rounds).
- Insert the magazine into the receiver, canting it forward (fig. 5-2) so that the lug on the top front of the magazine engages with its recess in the magazine well. Swing the magazine rearward until the magazine catch snaps into place.

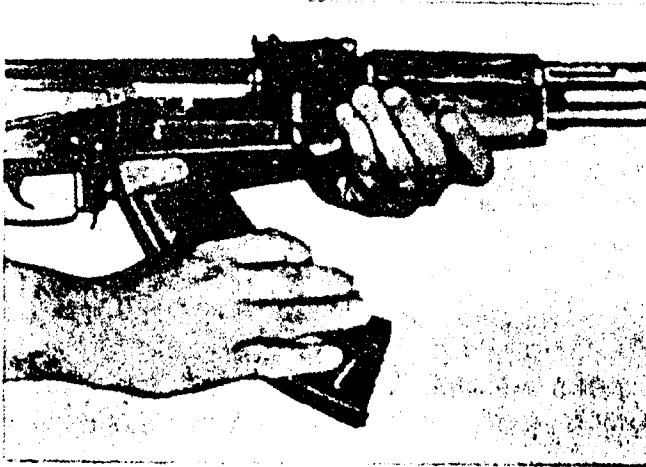

Figure 5-2

- If necessary, press the selector (fig. 5-3) down from the safe position; pull the operating handle (fig. 5-3) fully to the rear and release it. Caution: The rifle is now ready to fire!

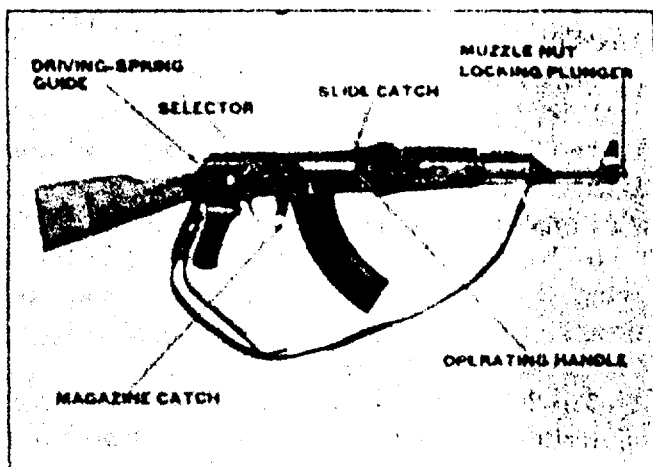

Figure 5-3

→ Unless the rifle is to be fired immediately, put it on safe by moving the selector fully upwards. This action locks the trigger and bolt; however, the bolt can still be opened sufficiently to ascertain whether or not a round is in the chamber.

→ Set the rear sight for the desired range by depressing the slide catch (fig. 5-3) and moving the sight bar along the leaf until the front edge of the bar is aligned with the line below the number that corresponds with the range in hundreds of meters. The first character on the sight leaf is a battle-sight setting used in combat for shooting at ranges up to 300 meters.

→ To fire, move the selector to its middle position for full automatic fire or to its bottom

position for semiautomatic fire; then aim--using a normal sight picture--and squeeze the trigger. The bolt will remain closed after the last round has been fired.

→ Remove the magazine by pressing the magazine catch (fig. 5-2) toward the magazine, then swinging the magazine forward and out of the receiver.

→ To clear the AK-47, remove the magazine and pull the operating handle fully to the rear. Inspect the receiver and the chamber to ensure that no cartridges are present, then release the operating handle.

#

28. HEADSPACE AND TIMING, MG CAL. .50

Headspace is the distance between the face of the bolt and the base of a cartridge fully seated in the chamber. Headspace adjustment is correct when the following conditions have been met:

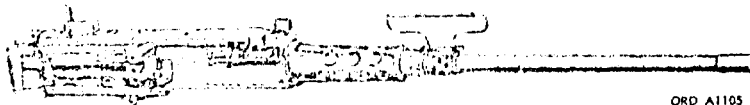

→ The recoiling parts are fully forward.

→ The breechlock is positioned in its recess in the bottom of the bolt with the forward surface of the breechlock in contact with, but not binding

against, the forward edge of the breechlock recess in the bolt.

→ There is no independent rearward movement between the bolt, and barrel and barrel extension.

Improper headspace adjustment can cause a poor shot group, improper functioning of the gun, and frequently, damage to parts and/or injury to personnel.

Headspace must be checked and/or set prior to firing: when the gun is assembled; when the barrel or any group in the receiver is replaced; or when headspace is in doubt.

In order to check and properly adjust headspace, the gun must be assembled correctly with firing pin in the cocked position, and the gun recoiling parts retracted far enough to the rear to show approximately a 1/6-inch gap between the barrel extension group and the trunnion block.

A headspace and timing gauge (FSN 4933-535-1217) is provided the user for each weapon. The gauge consists of two distinct sets of gauges:

The headspace gauge provides for two measurements marked on the gauge; a GO end 0.202 inch and a NO GO end 0.206 inch. Therefore, proper headspace is between 0.202 and 0.206 inch.

Two separate timing gauges are attached to the headspace gauge by means of a chain. The thin

gauge 0.020 inch is the FIRE gauge. The thick gauge 0.116 inch is the NO FIRE gauge.

Timing is the adjustment of the weapon so firing takes place when the recoiling parts are between 0.020 and 0.116 inch out of battery position. Early timing could result in the gun firing two rounds and stopping because recoil from the second round started before the extractor engaged the next round in the belt. Late timing results in parts slamming into battery and causing possible component damage. Timing should be adjusted and/or checked every time headspace is adjusted.

In a combat situation, a headspace adjustment may be made without a gauge if one is not available. With the gun fully assembled, and the recoiling parts retracted until the lug on the barrel locking spring enters the 3/8-inch hole in the right side-plate, screw the barrel all the way into the barrel extension. Unscrew the barrel two notches. If the gun operates sluggishly, unscrew the barrel, ONE, BUT ONLY ONE, additional notch.

#

29. PROPER CARE AND HANDLING OF AMMUNITION

Safety in the firing of weapons demands consistent adherence to proper procedures for the safe storage, handling and preparation of ammunition for firing. Every effort must be made to prevent the

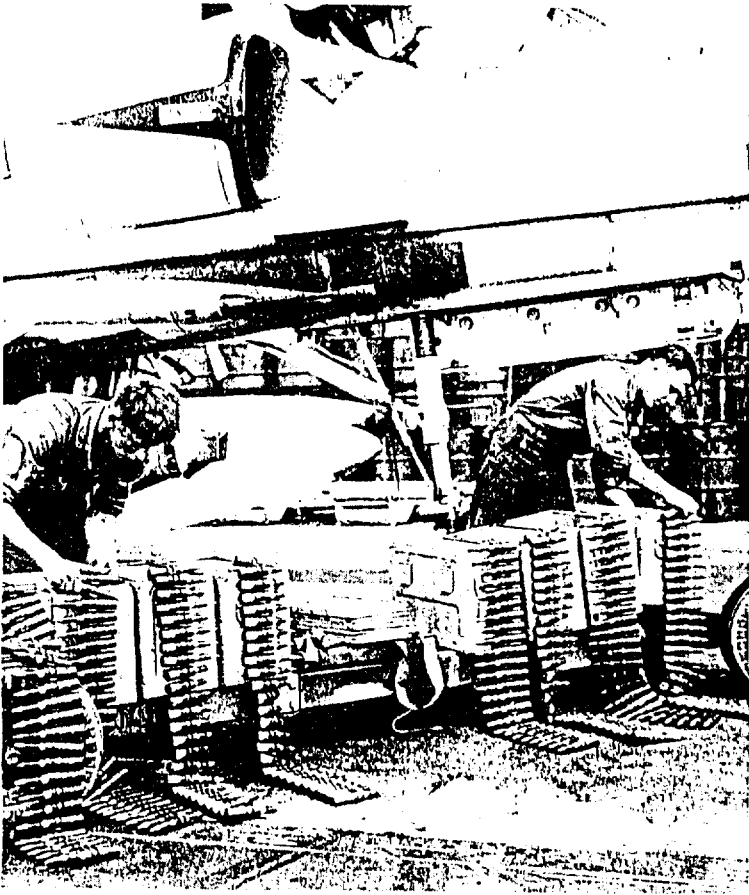

occurrence of malfunctions, to minimize their effects when they do occur, and to avoid their repetition. Here are a few hints to remember:

→ Check the status of ammunition lots. Make sure the ammunition lot is graded as suitable for firing, and take careful note of any restrictions imposed.

→ Unauthorized disassembly, alteration or substitution of ammunition is strictly prohibited. These prohibitions do not apply to the authorized procedures for replacement of substitute or special purpose fuzes, nor to the adjustment of increments for charge (zone) firing in accordance with approved procedures. Only authorized wrenches are to be used for assembling fuzes to, or removing fuzes from, projectiles. Hand tightening of fuzes is unacceptable.

→ Ammunition should be protected from rain and the direct rays of the sun at all times. Wet, hot, or dirty ammunition is not "ready ammunition."

→ Smoking in the vicinity of explosives and munitions is absolutely prohibited.

→ Care must be taken to prevent dropping projectiles, warheads, rocket motors, containers of black powder, propellants, fuzes and primers.

→ Moisture resistant seals on artillery and mortar rounds are not to be removed from containers until the ammunition is required for firing. Safety devices installed on rockets, fuzes, primers, pyrotechnics, etc., will not be removed until immediately prior to firing.

→ Each complete round, and each component thereof, should be thoroughly inspected by a member of the firing crew for burrs, gravel, dirt, grease, dents and other obstructions which could interfere

with proper seating and firing or cause excessive wear on the chamber or bore. Do not use wet increments or wet propelling charges.

→ Safety is the most important consideration when working with ammunition.

#

30. AMMUNITION STORAGE IN SVN

The combination of heat, humidity, and rain encountered in SVN deteriorates ammunition and its packaging very rapidly. Materials shipped and stored under such adverse weather conditions must have maximum preservation in order to sustain and/or lengthen shelf life in storage. The rate of deterioration may be reduced by providing protection specified in TM 9-1300-206. This involves overhead protection from the weather; ventilation over, through and under stacked ammunition and protection from enemy action. Each level of command must be prepared to exercise adequate ammunition management to ensure continuous availability of serviceable ammunition.

#

31. CLASS V(A) REPORTING

Personnel submitting ordnance expenditure reports must ensure that the report is complete and accurate. The expenditure of small items such as

fahnstock clips, delay elements, fuzes, and the ejection of munitions from aircraft without expenditure of ejection cartridges must be reported. The end result of a failure to report properly an expenditure of ordnance is a future shortage in munition stockpiles.

#

32. DUD MUNITIONS

Dud munitions such as artillery and mortar shells, aircraft bombs, rockets and naval shells are providing the VC with a lucrative source of practically readymade landmines and boobytraps. By employing a simple firing device with the salvaged munition, the VC rig landmines and



boobytraps which result in death or injury to hundreds of Marines.

Investigations of dud munitions very often reveal the cause of malfunction to be improper use of fuzes. Failure to remove shipping pins, fuzes screwed on improperly, and using the wrong-type fuze are some of the more common causes. These are errors that reveal carelessness, ignorance and a lack of training and supervision. Mistakes in combat are costly in lives and material; these are errors that can and must be corrected through proper training and supervision.

#

33. SAFE HANDLING OF FUELS

Petroleum fuels are potential hazards. Deaths and serious injuries have resulted from improper handling and storage of fuels. Careful handling and strict observance of a few relatively simple rules will prevent property damage and injuries.

Petroleum fuels require a source of ignition to cause them to burn or explode. In addition to the more obvious sources, ignition can be caused by the discharge of accumulated static electricity, atmospheric disturbances and high energy electronic sources. To minimize the danger in handling petroleum fuels, the following precautions should be followed:

→ Arrange storage areas to permit maximum separation of pumps from tanks.

- Ensure that all tanks, lines and associated equipment are properly grounded.
- Keep gauge hatches and covers closed during fueling.
- Do not use "splash" filling.
- Allow only essential personnel near fuel areas.
- When the level is low, fill at slow speeds.
- Mark all containers of fuel with clearly printed letters or other effective visual identification means.
- Observe all safety procedures in fuel areas!

#

34. LOADING PLANS

The review of an amphibious loading plan revealed that it would require 12 hours longer to unload one of the ship's holds than any of the other holds. With better planning by the embarkers, this excessive variation in unloading time could have been significantly reduced.

#

35. SHIPLOADING

One of the responsibilities of the commanding officer of troops embarking aboard amphibious and

MSTS ships is to provide a sufficient quantity of lumber for dunnage, shoring, and chocking.

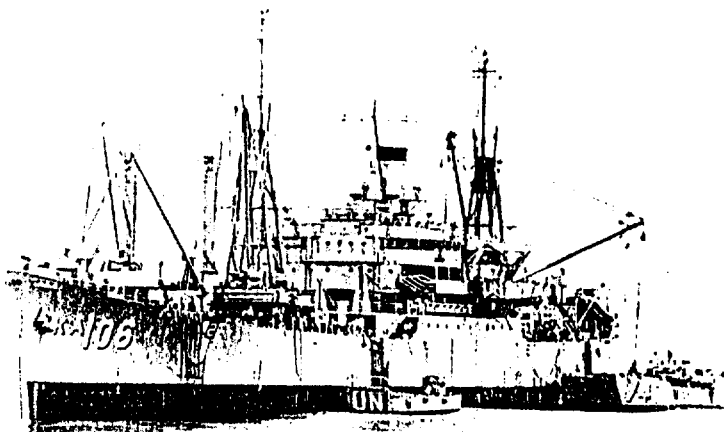

Past experience has shown that this lumber is often forgotten or intentionally left aboard ship when the vehicles and equipment are unloaded. As much of this lumber as possible should be retrieved for future use. This is especially important in RVN where lumber is scarce and more expensive, due to shipping costs. Retrieving this lumber not only saves the Marine Corps money, it also saves many hours in procuring and cutting large quantities of lumber for future operations.

36. WATER PURIFICATION UNITS AND RELATED 55 GPM PUMPS

Water purification units and 55 GPM pumps are a critical item in Vietnam and are in constant use.

The engine utilized in these units is a single-cylinder, 4-cycle, air-cooled engine, which requires a vigorous preventive maintenance program. Due to climate conditions and the workload that is placed on these units, extreme care must be taken to keep this equipment in an UP status. A malpractice that shortens the life of the engine is setting up the unit on a slope, thereby causing the oil in the engine to run to one side. This results in improper lubrication of the connecting rod and other internal components, which will, in a short period of time, deadline the equipment. The problems causing engine breakdown can be alleviated by the following:

- Place the engine on level ground so that the oil can properly lubricate the connecting rod and other internal parts.
- Conduct preventive maintenance every eight hours while employing backup units.

// // // // //

37. DEVICE FOR FILLING DISPOSABLE WATER CONTAINERS

In order to airdrop water, the disposable polyethylene waterbags are placed inside 155mm powder cannisters. These containers can be dropped from 60 feet or more without damage. The problem is in filling the bags with water when no filler machine is available. The bags must be placed inside the

cannisters before being filled. Filling from a water trailer is a slow process with the limited number of hose bibs.

A device was designed and fabricated by the 3d Shore Party Battalion that allows filling of five or more bags from each hose bib of the water trailer. This device consists of a standard-size water hose with five T's inserted at 13-inch intervals. Water containers can then be lined up five deep at each hose bib allowing up to thirty containers to be filled at one time using a minimum number of personnel.

#

38. PROPER HANDLING OF SECONDARY REPARABLE ITEMS

The availability of serviceable secondary reparable item components, such as engines, transmissions, generators, carburetors, etc., for major equipment in the secondary reparable float, is to a great extent dependent on the numbers of such unserviceable items received for repair, and the condition they are in.

Experience has revealed that the condition of many of these unserviceable items has deteriorated due to inadequate or improper handling techniques during the process of removal from end items, and subsequent preservation, packing, storing and retrograde to a repair facility. This failure to observe

correct procedures results in one or more of the following:

- The item deteriorates to the extent that it is no longer reparable.
- A greater repair effort is required.
- An increase in costs is incurred for the repair effort.
- The period of item nonavailability for exchange or issue is extended.

The removal of unserviceable secondary reparable components from major end items, and their subsequent evacuation to repair facilities, is a function of maintenance sections, and personnel therein should be knowledgeable and experienced enough to ensure that components arrive at the repair facility in no worse condition than when removed from major end items.

Commands must place continuing emphasis on proper handling procedures for the removal and evacuation of secondary reparable items in order to prevent further deterioration of the items.

Chapter VI: PACIFICATION AND PSYOPS



1. DEFINITIONS OF TERMS

Nearly every activity conducted by Marines in Vietnam is related in some way to Pacification, Revolutionary Development and Nation Building. Definitions of each of these terms are as follows:

→ Pacification - Pacification is the military, political, economic and social process of establishing or reestablishing local government responsive to and involving the participation of the people. It includes the provision of sustained, credible territorial security, the destruction of the enemy's underground government, the assertion or reassertion of political control and involvement of the people in government, and the

initiation of economic and social activity capable of self-sustenance and expansion. The economic element of pacification includes the opening of roads and waterways and the maintenance of lines of communication important to economic and military activity.

→ Revolutionary Development - Revolutionary Development (RD), the leading edge of pacification, is the formalized Government of Vietnam program under the sponsorship of the Ministry of Revolutionary Development. It is conducted in specified hamlets generally within RD campaign areas and includes the local security for those hamlets and the political, economic and social activities at that level.

→ Nation Building - Nation Building is the economic, political, and social activity having an impact nationwide and/or in urban centers. It is related to pacification in that it builds on the results of pacification and contributes to the establishment of a viable economic and social community.

#

2. BACKGROUND

(The following article first appeared in the March 1968 issue of the Marine Corps Gazette under the title "USMC Civil Affairs in Vietnam,

a Philosophical History." The author, LtCol D.L. Evans, Jr., served as assistant G-5, III MAF, during the formative months of the Marine Corps civil affairs program in the Republic of Vietnam. Reprinted here with permission of the author and the Marine Corps Association, the article offers a thorough but compact background on Marine Corps pacification operations in the Republic of Vietnam.)

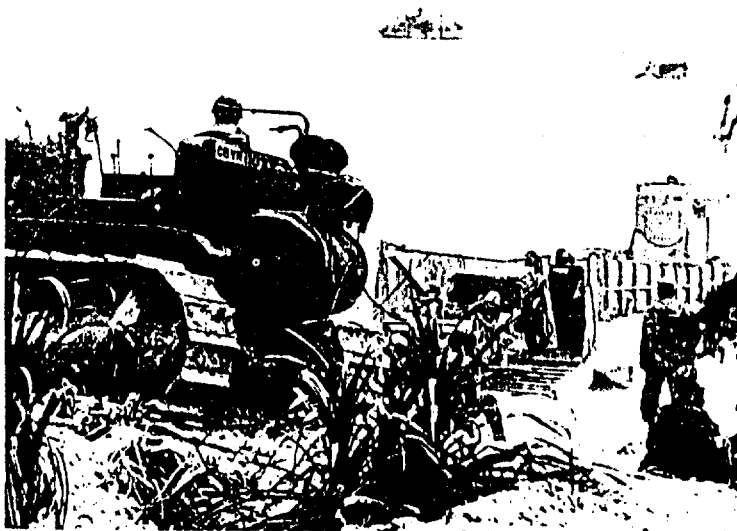

This is a story about the "Other War" - the campaign to deny the enemy the vital support of the people.

March 1968 marked the third anniversary of the landing of the first major combat elements of Marines in South Vietnam. They came in response to an invitation by the government of that country.

The armed forces of the Republic of Vietnam, and now the U.S. Marines, became committed to a war that seemed to defy solution. The enemy main force units posed no new problems; however, this could not be said for the Viet Cong (VC) guerrillas and the VC infrastructure, both of which had long been entrenched in most rural hamlets. These enemy elements derived the major portion of their support from the local populace. This support was sometimes freely given, but more often was exacted by fear, extortion, and terrorism. While the enemy main force units demanded the constant attention of the Government of Vietnam (GVN) Armed Forces, the VC guerrillas and infrastructure continued their efforts to alienate the people from their legally constituted government, with only infrequent interruptions. Continued successful application of this stratagem over a sufficient period of time would undoubtedly cause the people to lose confidence in the GVN and thereby pave the way for a VC victory. The ultimate goal was the willing or unwilling support of the people. The type of war being waged was obvious; an effective means by which to counter these thrusts was not so obvious. This was the situation in March 1965.

Established ashore, the USMC capability for offensive action was severely curtailed because of the primary mission of airfield defense. Thus, the majority of Marine units found themselves in a static defensive role, physically located in the densely populated area which surrounds the

airfield complex at Danang. Also, they daily found themselves face to face with an environment that included the VC guerrillas and infrastructure. They were constantly reminded of this unseen VC presence by the boobytraps, snipers and terror incidents which occurred nearby. Lacking sufficient forces to both guard the airfields and to search for enemy main force units, they concentrated their efforts against the local guerrillas. They realized that counteraction against those few guerrillas who disclosed themselves was not the total answer. The solution, if one could be found, was to win the support of the people, and thereby deny that support to the VC. They also realized that the main thrust of the people's support should be for their own legal government, and secondarily for the USMC. A modest civic action program was initiated in an effort to gain that necessary support of the people. All too often civic action projects were of necessity conducted unilaterally because of the lack of available GVN support, however, the guerrilla was of immediate concern and so was the need for civic action.

Civic Action Commodities

Limited initially to use of USMC organic resources, civic action projects were oriented toward medical assistance, repair of existing roads and facilities, and minor new construction projects. The doctors soon discovered that many of the superficial ills of the people, such as rashes and sores, could be cured by simply keeping the



infected areas clean. The result was a loud plea for soap soon heard throughout the United States. The response from the ever generous American public was not long in materializing. Notification of successful soap collection drives poured into Marine Corps offices throughout the country. Transporting the soap and other commodities to Vietnam immediately posed a serious problem to the

existing pipeline, already overloaded with military supplies. The problem was solved by shipping civic action commodities on a space available basis, via whatever transport means available. Project HANDCLASP coordinators were designated at Norfolk and San Diego, where commodities were collected, stored in warehouses, and offered for shipment. This system, now expanded to eight warehouse locations, continues to provide the major portion of civic action commodities being used in I Corps today.

U.S. Civilian Agencies

The presence of a number of U.S. civilian agencies in I Corps was known to the Marines from the outset, though interrelationships had not been developed at that time. The mutual need for coordination and cooperation immediately became apparent when the civic action program began. The civilian agencies possessed commodities, but lacked the manpower to provide an effective system of distribution and control. The Marines were in daily contact with the civil populace located in and adjacent to the areas which they controlled militarily, but they needed commodities for use in the civic action program. A natural alliance for mutual support soon developed, which continues to grow in effectiveness today. The largest civilian organizations in I Corps in regard to available commodities were the U.S. Agency for International Development (USAID), the Cooperative for American Relief Everywhere (CARE) and Catholic Relief

Services (CRS). USAID representation in I Corps consisted of a Regional Office located in Danang; and a provincial office located in the capital city of each of the five provinces. CARE and CRS each had one representative for the entire corps area, both located in Danang.

The need for a means to ensure continuous coordination and cooperation, between the various agencies and organizations which shared an interest in winning the willing support of the people for the GVN, resulted in formation of the I Corps Joint Coordinating Council (JCC) in August 1965. This Council's membership includes senior representatives of all major U.S. and GVN organizations and agencies, both military and civilian, located in I Corps. The Council, as such, has no directive authority or funds, but through its senior membership has access to the sum total of the available authority and resources. The mission of this Council is to monitor progress of the GVN Revolutionary Development (RD) Program, and to provide a ready forum for frequent discussion of attendant problems. This group meets weekly and conducts one meeting each month in one of the province capital cities for a more detailed look at RD progress within the province. The Council has eight permanent committees which monitor the interest areas of public health, education, psychological operations, roads, refugees, commodities distribution, agriculture and police. In the fall of 1966, the Council encouraged and assisted with the formation of province-level

joint coordinating councils. These JCC's are independent of the corps-level council, but have parallel organizations and missions. The steady increase of GVN participation in Council activities and Council sponsored programs is significant in assessing the value of the JCC.

By the end of the summer of 1965 the III Marine Amphibious Force had developed the framework of the organization which was to conduct its civic action program. A 5th general staff section was created which was called the G-5 Section. This section was assigned the staff responsibility for the conduct of civil affairs which included civic action. The 3d Marine Division followed suit and established a G-5 Section. Regiments and battalions appointed civil affairs officers; however, since additional Marines were not initially available, one staff officer in each of the units was assigned this task as an additional duty. This organization facilitated the development of effective techniques for distribution of civic action commodities for dissemination of civic action information, and for collection of data for use in evaluating the effectiveness of the program.

A need for a system to control the distribution and end-use of commodities, and a system for preventing overlap of projects soon developed. III MAF responded by assigning specific areas for civic action coordination to each of the major subordinate units, along with instructions for these

commands to further subdivide the areas for assignment to their subunits. This system accomplished two things. It provided for one civic action officer to continually coordinate with the same local GVN officials located within his area, and it required coordination with other civic action officers to conduct civic action in another unit's assigned area. Civic action area boundaries were drawn along political boundaries to the extent allowed by the military situation to further facilitate coordination between local GVN officials and civic action officers. Consideration was given to the principle of assigning larger segments of rear areas to supporting units, thereby limiting the size of the areas assigned to the combat units located on the periphery of the tactical area of responsibility (TAOR). Other U.S. military units, located in I Corps but not under the operational control of III MAF, participate in the III MAF Civic Action Program by mutual agreement. The considerable capabilities of the Naval Support Activity (NSA), the Naval Construction Battalions (SeaBees), the U.S. Army and U.S. Air Force units and the Korean Marine Brigade are in this way added to the total resources for civic action. III MAF civic action commodities are provided for use by these units.

USMCR-CARE Civic Action Fund

As the civic action program matured other needs and problem areas became evident. Requests for

commodity support often could not be filled due to the lack of certain needed items and due to the uncertain arrival time of materials being shipped on a space available basis. This situation often resulted in embarrassing delays, and it tended to erode the overall effect of the program. As though in answer to this problem, the Marine Corps Reserve concluded an agreement with CARE whereby the USMCR would solicit money for support of the III MAF civic action program, and CARE would act as the custodian of the fund. This program immediately proved successful, and III MAF was provided with one of the most flexible and useful civic action tools in its inventory.

The Medical Civic Action Program (MEDCAP) was one of the first programs to be implemented. It was immediately successful since it provided an excellent opportunity for rapidly establishing good rapport with the people. The intentions of this program could hardly be misunderstood, and the effect upon the people was one of personal benefit. All too often, this program was conducted unilaterally because of the very limited number of GVN medical personnel, and also because of the scarcity of trained rural health workers. Those who were available were invited and encouraged to participate. On-the-job training was given to volunteers who offered to assist the MEDCAP teams, and in this way the local people were encouraged to contribute to the welfare of their own community.



As good health is a prerequisite to the general well being of the people, so is education a prerequisite to their economic, political and social development. The MEDCAP efforts produced rapid, tangible and personal results. An education program offered none of these advantages, however, the vital need could not be ignored. In the Spring of 1966, III MAF developed an effective school-

building program, easily the most complicated civic action program developed to that time. Some units had already constructed classrooms as a part of their civic action programs with varying degrees of success. Lessons learned were considered in the development of the III MAF program, and other proven techniques were carefully incorporated. Detailed guidance was issued to subordinate units in order to minimize problems inherent in any undertaking of this magnitude. Certain requirements had to be met by each hamlet which desired to participate in the program:

- An adequate site must be provided.
- The people must agree to provide self-help labor for construction.
- A teacher must be provided and a salary for the teacher guaranteed.

III MAF agreed to provide in return, construction materials, technical advice, and equipment for clearing and grading the site. Before applications were approved, each location was coordinated with appropriate GVN officials and with USAID to ensure compatibility with other school building programs. Blueprints used for classroom construction by the GVN were reproduced and distributed to ensure uniformity of construction and to enhance the concept that a Vietnamese classroom had been built by Vietnamese. The

USMCR-CARE Civic Action Fund proved to be invaluable in support of this program by providing a ready means for acquiring special hardware items not available through other sources.

Several bonus effects were realized as a direct result of this program. The participating Vietnamese gained a sense of pride and accomplishment, acquired a knowledge of the trade skills



involved, and gained a feeling of community spirit. Civic Action officers learned the value of detailed planning in connection with major civic action projects. During the planning stage of the classroom construction program, an earthblock factory was established which employed a number of refugees who lived nearby. An engineer unit sponsored this project. A large number of these blocks

were formed and stockpiled, and subsequently used for classroom construction in areas where suitable soil was not available for block making.

In June of 1966, the U.S. Army 29th Civil Affairs Company arrived in Danang, and was attached to III MAF. This company was activated, organized and trained specifically for the purpose of augmenting the III MAF civic action program. The company consisted of a headquarters element, six civil affairs platoons, and a number of functional teams. The civil affairs platoons are capable of supporting regimental or division sized units, and the functional teams are capable of providing technical advice at the corps level concerning their particular civil affairs specialties, including public health, agriculture, refugees, education, public safety, legal and others.

The platoons were initially attached to the infantry regiments and immediately began the necessary task of developing civil affairs studies for their assigned areas. The finished studies provided necessary statistics, identified problem areas, and included recommendations for corrective action. The functional teams were retained at III MAF, and initially assigned the task of developing corps-wide civil affairs studies relating to their functional specialties. Concurrently, all elements of the company established liaison with their logical counterparts, both U.S. and GVN. They became an active and effective addition to the existing civic action program. Addition of this

company to the III MAF organization for the conduct of civic action greatly increased the capability of both planning and conducting this program.

Operations Related to Civic Action

Many types of combat operations support the GVN Revolutionary Development Program and the III MAF Civic Action Program, however, three of these warrant special attention due to the close relationship which has been developed.



The Combined Action Unit Program was first implemented in the fall of 1965. A USMC unit was integrated with a GVN Popular Force (PF) unit. This Combined Action Platoon (CAP) moved into a hamlet, provided protection for the people

and thereby denied this hamlet to the VC. Members of this combined unit shared rations and quarters, trained and fought side by side. Eventually they gained the confidence of the people who furnished the intelligence which enabled the unit to kill and capture a number of local guerrillas. This program has been developed and refined, and is now standardized in organization and technique of employment. Today the organization consists of one Marine rifle squad -- augmented with one hospital corpsman -- which is combined with one GVN PF platoon. This unit is assigned the mission of providing protection for a particular hamlet. These men, like the original CAP, share rations and quarters and train and fight side by side. The VC has never regained control of a hamlet which is protected by one of these units. Plans have been made to increase the number of CAPs due to the success thus far achieved.

The County Fair concept was first employed late in 1965. The purpose of this operation is to isolate a hamlet, evacuate the people, and to thoroughly search the area for VC and VC supplies and equipment. When this mission is accomplished, the forces withdraw. The name County Fair stems from the techniques developed for processing and occupying the time of the people who have been assembled in an area adjacent to but outside the hamlet proper, in order to prevent the development of hostile attitudes. Today, this operation employs a combined force of USMC and GVN



units. The USMC elements surround and isolate a selected hamlet during the night. At first light, the GVN elements evacuate the people to a pre-selected assembly area located inside the USMC protective encirclement. The GVN combat forces then thoroughly search the hamlet, and capture or destroy all VC, their supplies and equipment, and their hiding places such as caves and tunnels. Concurrently, GVN specialist forces assisted by U.S. forces, conduct that portion of the operation for which the name County Fair is given. Here, shelter from the elements is provided, as well as food and drink. A medical sickcall is conducted. The entire population is screened by the national police and counterintelligence officials in an effort to discover any VC guerrilla or member of the VC infrastructure who has chosen to mingle

with the people. Psychological operations are conducted which normally include explanations of the purpose of the operation and the U.S. presence in the area, entertainment in the form of movies and performances by cultural drama teams, and a proportionate amount of propaganda. This operation normally lasts for 1 to 3 days.

Golden Fleece operations are conducted during the harvest season to provide security for the local farmers and their harvested crops. Both GVN and U.S. forces conduct these operations to deny this source of support to the VC, and to demonstrate to the farmers that their government can and will support them.



GVN Revolutionary Development Program

Early in 1966, the GVN implemented a plan designed to provide hamlet security and community development. The newly created Ministry of Revolutionary Development was given the responsibility for the conduct of this Revolutionary Development (RD) Program. Lessons learned during conduct of previous similar programs were considered in development of the current plan and the new ministry was created in an effort to provide close supervision and required support. Reviews of the plan by U.S. agencies produced favorable comments. Some problems and deficiencies only became apparent after the program was launched within the provinces.

Sufficient numbers of trained cadre in the specialist fields such as public health and refugee administration were not available to properly support the program. Military security forces, assigned to protect the selected hamlets, were often withdrawn without advance notice to perform some other needed military function. The budget for support of the RD Program was published as a consolidated document, however funds for support of specialist functions such as public health, education, and others remained under the direct control of those particular ministries. As a further complication, the entire country was subjected to several waves of political unrest during the first half of 1966, which resulted in very few decisions being made by high ranking government

officials during this period. The RD Program achieved some of its goals in 1966, but the results were nowhere near that which had been hoped for. The Ministry for RD closely monitored the program throughout the year and gave assistance to the provinces when and where it could. During the year a program was initiated by the Ministry of RD to form and train RD teams which would conduct the RD Program within the hamlets. In the fall a revised RD plan was issued which corrected some of the earlier deficiencies.

The current plan eliminates many of the pitfalls discovered during conduct of the RD programs for 1966 and 1967. The basic element of the RD Program is the team. This team, if properly trained, can accomplish its mission within the hamlet to which it has been assigned. The GVN has assigned the mission of providing continuous security for the hamlets, within which the RD teams are employed, to the regular army forces.

Considering these improvements, it appears that the chances for successful conduct of the RD Program this year are better than ever.

In January of 1966, all U.S. Government civilian agencies and organizations in Vietnam became an integral part of the newly formed Office of Civil Operations (OCO), formed for the purpose of ensuring continuous coordination of the several U.S. Government civilian programs being conducted in support of the GVN RD Program.

As a further step toward improving support for the GVN Revolutionary Development Program, all U.S. civilian and military resources which directly support the RD Program were integrated and the Office of Civil Operations and Revolutionary Development Support (CORDS) was established in May 1967. This single manager concept, under the direct control of the Commander, U.S. Military Assistance Command Vietnam, ensures close coordination of the RD support activities of all U.S. civilian (OCO) efforts, as well as the military efforts of the Military Assistance Advisory Group and the military field forces. Regional, provincial, and district CORDS organizations are patterned after the national-level organization.

Gaining the support of the people for their legally constituted government has become a major objective in this war--perhaps the major objective. Tactics and techniques for achieving this goal are still being developed. The military threat cannot be ignored, but neither can we ignore the more subtle threat of the VC guerrilla and the VC infrastructure. The civic action programs conducted by the Free World Military Assistance Forces and Revolutionary Development Program conducted by the GVN are proving their merit in the war for the support of the people.

(Editor's note: As planned, there has been a major increase in the number of CAP's. Further development of the combined action program has brought the establishment of combined action

companies (CACO's) controlling several CAP's, and combined action groups (CAG's) controlling several CACO's. Under this system the Commanding General, III MAF exercises direct command and operational control of all combined action units. Except in unusual situations combined action units are not placed under the operational control of adjacent Marine infantry battalions. However, a working policy of close cooperation and coordination exists between the CAP's and larger adjacent units. The nearest Marine infantry battalion still provides fire support coordination, and joint patrols and operations are carried out, the CAP Marines serving as an important bridge between the local people and the larger Marine formations.)

#

3. SUCCESSFUL CIVIC ACTION TECHNIQUES

Civic action techniques which proved successful when Marines first landed in Vietnam remain valid today.

The first major civic action and pacification effort was undertaken by Marines in Vietnam in May 1965. Marines, in conjunction with local GVN officials from Hoa Vang District, cleared the Viet Cong from Le My (known to the local people as Hoa Loc) village, eight miles northwest of Danang. The intent of the operation was to initiate securing and rebuilding of the area, which had



been under strong VC control and influence for many years. Civic action techniques utilized by the Marines at Le My proved highly successful and laid much of the groundwork for today's civic action program in Vietnam. The following were the basic lessons learned at Le My:

Security is the Key to Successful Civic Action

The first order of business in the Le My operation was the clearing of all Viet Cong from the village. This was accomplished through a coordinated Marine/GVN clearing operation within the village. Once the enemy had been removed, both Marine and GVN forces were placed into and adjacent to the village to provide continuing

security for the inhabitants and GVN officials. Once security was established, pacification and civic action commenced unhindered by the enemy.

Win the Confidence and Support of the People

When Marines first entered Le My they found the inhabitants frightened and uncooperative. The people had been propagandized by the enemy,



who had convinced them that the Marines were in Vietnam to kill them. Many of the inhabitants fled their homes as the Marines arrived. Realizing that the success of the pacification effort in Le My would rely upon gaining the willing support of its people, Marines immediately initiated small, high-impact civic action projects, including the establishment of a dispensary for the people. In

addition, good rapport with the local inhabitants was established by the Marines at all levels down to and including the individual Marine rifleman. As a result of these actions, the inhabitants soon became aware that the Marines had come as friends and not as their enemy. As the Marine civic action expanded, a snowball effect resulted, and more and more people began to return to Le My to enjoy the security provided by the Marines' presence, and to benefit from the improved living conditions made possible through Marine pacification efforts.

The success at Le My could not have been possible without the assistance of the local GVN village and hamlet officials. All Marine civic action efforts were channeled through the local officials, beginning with the Hoa Vang District chief down to the hamlet officials. All Marine pacification efforts were designed to restore the confidence and loyalty of the local people in their government. Every civic action accomplishment was attributed to the local GVN officials within the area. In addition, Marine efforts were directed at developing a local government which could respond to the needs of the people without U.S. assistance.

Coordination is a Vital Ingredient for Success

Coordination proved to be vital in the accomplishment of civic action at Le My. In addition to the closely coordinated combat operations between Marine ground and supporting units, close

coordination with GVN civil and military units was also conducted. Further, heavy emphasis was placed on civic action during operations. Only through detailed, coordinated planning at all GVN and U.S. civil and military levels was the Le My operation successful.

Today, the village of Le My enjoys a high level of pacification. The social and economic conditions of the people, coupled with their restored confidence, in and loyalty to their government, are testimony to the success of the Le My operation in the early days of Marine presence in Vietnam.

#

4. VIEWPOINTS FROM PERSONAL RESPONSE

There is something debasing and humiliating about being cursed or called uncomplimentary names. We become bitter and resentful toward the person involved. It helps if you can fight back either with words or physical force. But bitterness and resentment are more severe when we are unable to fight back . . . when we must just accept the abuse because of fear or other circumstances.

The Vietnamese are in this latter frustrating position. They feel bitter and resentful when they are cursed or called degrading names. But, with their country overrun with strange military

IN VIETNAM:



YOUR BUDDY MAY BE "FUNNY", BUT...
THE LIFE HE JEOPARDIZES MAY JUST
HAPPEN TO BE YOUR OWN!

IN CASE HE DOESN'T KNOW, TELL HIM THAT
"THE CUT OF A KNIFE WILL HEAL IN A FEW
DAYS. THE CUT OF THE WORD LASTS FOREVER!"

DECENCY AND COURTESY COST NOTHING,
BUT IN RETURNS THEY CAN BE PRICE -
LESS

forces, they can't do anything directly about it. The only way they can fight back is quietly and indirectly. It could be that their chance will come when they are told by the VC to remain quiet about a proposed ambush or a mined trail.

Besides, it's not their way to fight back with words or hostile actions. They have always been taught that shouting names at each other is the way children behave. We sometimes seem to think just the opposite, that cursing and calling people names is a sign that we're grown up, tough or even funny.

This is an instance where we can learn from the Vietnamese. We can learn that cursing and uncontrolled anger are not a sign of maturity after all. We can also learn that words are both powerful and dangerous. They can do a great deal of good when properly used. They can cause a great deal of pain and misunderstanding when they are used thoughtlessly. The Vietnamese have a saying: "The cut of a knife heals in a few days but the cut of a word lasts forever."

#

5. RESULTS ARE AS IMPORTANT AS MOTIVES

The American serviceman is normally quite generous in helping those who seem to be in need. Sometimes, however, while the motive behind his



gifts and actions may be excellent, the techniques and methods he uses can be misunderstood and do more harm than good. The random distribution of candies, money, cigarettes, etc., especially among children, may create a habitual attitude of dependence which can come to be resented by both Vietnamese and Americans. On the other hand, gifts and services that are carefully planned and administered in close cooperation with respected Vietnamese leaders can help bring about the self-respect and progress so vital to intercultural endeavors. Careful consideration should be given, both by individuals and organizations, to a determination of what practical help is needed, what indigenous peoples can - or prefer to - do for themselves, and how valid mutual involvement can be achieved. The finest gift that can be given is that one which helps a person, or a people, to help themselves.

#

6. THE CHIEU HOI PROGRAM

The SVN Chieu Hoi program, initiated in 1963, is the program under which amnesty is provided to persons who have given active support to military, political or economic activities of the VC/NVA and who voluntarily decide to return to the side of the SVN. "Chieu" means to appeal, while "Hoi" means to return.

In addition to weakening the enemy by loss of his forces through defections to the SVN, other important benefits are gained by the SVN from

the Chieu Hoi program. These include valuable intelligence information and the services of the returnees in support of SVN/FWMAF tactical and psychological operations. Tactical support includes assistance in locating and identifying enemy personnel and in disclosing the hiding place of enemy weapons and supplies. Psychological operation support includes writing letters by the Hoi Chanh (Chieu Hoi ralliers) to the remaining enemy and making tape recordings for aerial and ground loudspeaker broadcast to encourage other defections.

Under the Chieu Hoi program, defectors are given food, clothing, shelter, safety, the opportunity to be with their families, and vocational training or jobs.

After defecting, the returnees are retained for two months in one of the 52 Chieu Hoi centers located at the province, region (corps) or national level. The higher ranking defectors are sent to the National Chieu Hoi Center at Saigon, where political indoctrination is most intense. There are six Chieu Hoi Centers in I CTZ, one in each province plus one in Danang.

#

7. CHIEU HOI INTELLIGENCE SOURCE

Experience has proven that one of the most profitable sources of intelligence is a returnee (Hoi Chanh). Many times the returnees have led

U.S. and ARVN troops to secret tunnels where weapons and supplies have been located. The returnees also provide U.S./ARVN intelligence agencies with names of VC in the different villages. Immediate operations to exploit this type of intelligence, with the returnee accompanying the unit, have proven most successful.

#



8. CHIEU HOI LEAFLETS

Through interrogation of a VC captive who belonged to the D14 Bn, Mobile Force, Tay Ninh Province, it was learned that each VC carries a Chieu Hoi leaflet. He is instructed that in case of capture, he is to present the document and

claim that he was on his way to rally. The captive who furnished this information also used this tactic and only after several days of interrogation did he admit that he had no intentions of rallying prior to his capture. A man who is captured automatically loses any rights he may have had under the Chieu Hoi program. He is a VC and should be treated as a prisoner of war until proven otherwise.

#

9. EXPLOITATION OF VC VULNERABILITIES

A published analysis of VC vulnerabilities by an independent research organization, based on hundreds of defector interviews, underlines the continuing validity of psyops appeals prescribed in current mission psyops policies. However, the hundreds of interviews, including nearly 90 in depth case studies, conversations, and visits by the researchers to most of the Chieu Hoi centers, have revealed certain additional vulnerabilities. Some different techniques and directions are also suggested by the evidence at hand. Psyops personnel at all levels should find it profitable to apply these to the continuing task of increasing the defection rate, one of the surest ways of shortening the war.



The continuing vulnerabilities, reconfirmed by the depth studies, include:

→ War weariness; hardships and deprivations; home-sickness and nostalgia for friends and relatives; disapproval of personally observed cadre actions that are in contrast with previous cadre statements or promises made during indoctrination sessions.

Indications of divisive tendencies spotted among the VC in earlier studies continue and involve a certain amount of friction between northerners, regroupees and southern cadre, the former two

being considered overbearing by the southerners. While this is not clearly brought out in the study interviews which took place during 1966, the increased integration of northern cadre and NVA officers into understrength main force VC units might even have accentuated these stresses. Other strains have to do with the inequality of treatment between officers or civilian cadre of all ranks and the ordinary main force soldier or guerrilla, the outlook of the well-indoctrinated oldtimer and the recent recruit, who in an increasing number of cases has been forcibly impressed into service, and the constant self-criticism sessions which are stage-managed by the cadre and cordially disliked by the participants. A man's social origins are also held against him in the VC ranks. Though a good many VC leaders come from a middle class or landholding farmer background, there is considerable career discrimination against men of these backgrounds and cadre ralliers often cite these discriminations as one reason for rallying.

There is no marked change since the earlier vulnerability studies in the deterrents to rallying. Besides tight discipline, strict controls and continuing indoctrination, major deterrents remain in the fear of being mistreated upon capture or surrender, and the conditioned disbelief or suspicions concerning U.S. war aims and the mass U.S. involvement in Vietnam. VC indoctrination has been quite successful in depicting Americans, to those who have no firsthand

experience with them, as a surrogate for the French and continuers of the white colonial tradition.

The latest findings confirm that a majority of ralliers appear to abandon the fight as a consequence of realizing VC failures and falsehoods rather than as a positive decision of commitment to the GVN. Many continue to regard the ultimate aims of the VC as just, and their pursuit of them as commendable. Though they may feel that the revolution and themselves personally have been betrayed by their leaders, they consider as a personal reproach strident propaganda that assails VC aims and ridicules VC adherents.

While these are rather standard Chieu Hoi deterrents and vulnerabilities that have appeared to date in every study of rallier motivations, some new findings point the way to further analysis and the search for new techniques. For example:

→ Certain days are believed to be unlucky and therefore inauspicious for such activities as rallying. These include the 5th, 15th and 23rd of the lunar month.

→ Loudspeaker appeals appear to be especially effective at night.

→ Villagers of VC-controlled areas sometimes go to market towns, district and even the province capital despite VC prohibitions. Market centers

and district towns contiguous to VC-controlled locations should be considered particularly promising for getting word-of-mouth communications on the Chieu Hoi program back to potential ralliers.

→ The cadre require a political rationale for making a break, in addition to the GVN career incentives which form the core of the Dai Doan Ket program (National Reconciliation - a program which offers a NVA/VC defector a position commensurate with his present responsibilities). Generally, the higher the cadre, the more sophisticated the rationale and the better the job offer will have to be. Citing progress by the GVN in achieving reforms, eradicating social injustices, helping workers and farmers, and pursuing the national objectives to which the NLF pays only lipservice, can help in pushing higher ranking cadre over the brink to defection. But the technique will only work with cadre already nagged by self-doubt and war weariness.

→ A predictable cadre reaction is linked to combat situations. The leaders of battered units, according to study findings, tend to be more vulnerable to Chieu Hoi appeals as a direct consequence of the defeat and hardships sustained.

→ Higher level cadre are said to be generally fond of radio listening and are freer to listen than the men under their control. Hoi Chanhs identify BBC as a major source of news and information, chiefly because of its credibility image.

→ Interviews continue to confirm the primacy of radio and loudspeaker systems as the principal sources of information in rural Vietnam. This is true also within the Chieu Hoi reception centers.

→ Within the centers themselves, according to the study, there are some cautions to be observed. These include meticulous observance of the promises made in the Chieu Hoi campaign literature, for confidence in GVN promises concerning fair treatment is the decisive factor in the Hoi Chanhs' final decision to rally. Treatment at the centers, it is stated, is rarely brutal but frequently degrading, and there is continued apprehension among the ralliers, leading to wild rumors, when cadre returnees are transferred between centers or to the National Chieu Hoi Center in Saigon.

→ Besides continuing with the exploitation of Viet Cong psychological vulnerabilities reconfirmed by the study, headquarters and field psyop should pursue the new leads indicated, including statistical verification of the allegedly inauspicious days for rallying.

→ In the field, the use of loudspeaker systems, particularly at night, should be intensified. The greatest use should be made of radio and camp loudspeaker/public address systems for information and educational programs at the Chieu Hoi centers.

→ A constant effort needs to be made to ensure speedy and courteous processing of Hoi Chanhs at the reception centers, with full performance on the promise made in the Chieu Hoi campaign leaflets. To quiet rumors, returnee cadre transferred to Saigon or another center should be encouraged to write back to friends at the former center. Visits to Chieu Hoi centers by some important ralliers at the National Chieu Hoi Center should be arranged. The word will spread that they are unharmed.

→ Leaflet and broadcast appeals to the cadre should continue to provide a political rationale for rallying, stressing GVN achievements in the development of representative institutions, VC

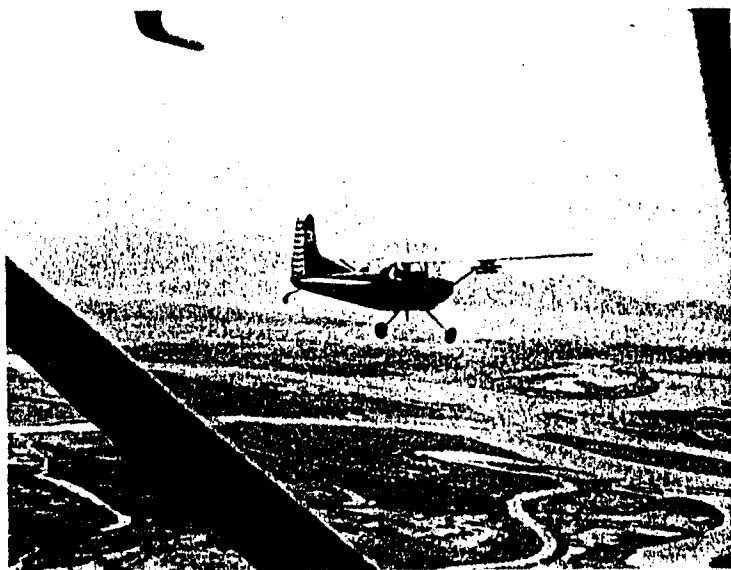

nonperformance, and opportunities for responsible cadre service on the GVN side through the Doan Ket program.

→ Constant caution should be observed by leaflet authors not to insult, humiliate or ridicule the Viet Cong and not to make VC members an object of caricature or satirical drawings. Psyop material should continue to direct criticism at VC methods that are not in the people's interests and at VC failures to carry out their promises.

→ Finally, a special effort should continue to be mounted in the distribution of Chieu Hoi materials addressing itself directly to VC-controlled areas. They may have family members among the VC and every available medium and technique should be employed to get word to them on the advantages of the Chieu Hoi program. Besides printed materials, this should involve the use of armed propaganda teams, the dramatic skits of the Van Tac Vu (cultural drama) teams and word-of-mouth campaigns by the local Vietnamese Information Service.

#

10. LEAFLET DISTRIBUTION

Experience has shown that face-to-face communication is one of the best ways of achieving psychological warfare objectives. Because of the



certainty of delivery, hand distribution of leaflets is one of the most effective means of accomplishing face-to-face communication. For this reason, units should consider having patrols carry leaflets. The themes of the leaflets to be used will vary with the mission of the particular patrol. Support of the GVN and reward themes should be emphasized when leaflets are handed out to civilians. Free World military might and the futility of the communist cause should be stressed when leaflets are left on known VC/NVA trails. Chieu Hoi themes have wide application and can be used in both of these situations. Providing patrol members with a packet of assorted leaflets and instructions as to distribution of the leaflets can be useful in furthering face-to-face communication.

Chapter VII: MEDICAL

1. THE CORPSMAN AND THE UNIT ONE

In combat situations and other emergencies the call "corpsman" is frequently heard. In reply to this call, the corpsman and his "Unit One" willingly respond to render whatever aid possible.



The official name for the Unit One is Surgical Instrument and Supply Set, Individual, and is listed in the Federal Stock Catalog under FSN 6545-927-4960. To all who have responsibility for the use and maintenance of a Unit One, the question is asked "Is your Unit One up to par?"

The Unit One case is available as a standard stock item: FSN 6545-912-9870 Case, Medical Instrument and Supply Set, Nonrigid, No. 3 Empty. The case should be requested through the normal supply channel.

Frequent complaints have been received concerning the failure of the snap-spring on the closing strap. Sand and rust are the greatest contributors to the failure of the snap-spring. In addition, these same two enemies attack the zippers of the individual compartments of the Unit One. To solve the rust problems, a very small amount of light oil or light petroleum jelly may be applied to the spring and zippers; however, ensure that a small amount is used because oil or grease mixed with sand produce undesirable side effects. Once the oil has been applied, brush away all excess with a small brush. Continue to brush these parts at frequent intervals to remove deposits of sand or other foreign material.

The Unit One requires cleaning from time to time. The outside of the plastic-coated case can be cleaned easily by brushing away soil deposits and wiping with a damp cloth. To clean the individual compartments, it will be necessary to remove the contents, shake out any sand, and wipe down the inside of the compartment with a cloth. Don't forget to give the snap-spring and zippers a careful brushing as the last step in cleaning the Unit One.

The question arises from time to time about carrying "extra items" in the Unit One. Space in the Unit One is very limited. Prior to placing any "extra items" inside the case, seek the guidance of the responsible medical officer, as he will have knowledge of the peculiarities of the environment which may affect this decision. In any event, do not

make arbitrary substitutions of the standard Unit One Items.

#

2. ARTIFICIAL RESPIRATION

Casualties in combat zones are frequently caused by accidents and not by direct enemy action. Some of the injured may require artificial respiration. The mouth-to-mouth method permits more air to enter the casualty's lungs than any other known manual method. Use this method if breathing has stopped after drowning, electrical shock, carbon monoxide poisoning, suffocation, etc.

- Place casualty on back immediately. Do not waste time moving him to a better place, loosening clothing, or draining water from his lungs.
- Quickly clear mouth and throat. Remove mucous, food, false teeth, and other obstructions.
- Tilt head back as far as possible. The head should be in a "chin up" or "sniff" position and the neck stretched.
- Lift or push the lower jaw forward. This will prevent the tongue from blocking the airway.
- Pinch nose shut. Prevent air leakage.
- Open your mouth wide and blow. Take a deep breath and blow forcefully into mouth or nose until you see chest rise.

→ Listen for exhalation. Quickly remove your mouth when chest rises. Lift jaw higher if casualty makes snoring or gurgling sounds.

→ Repeat the last two actions twelve to twenty times per minute. Continue until casualty begins to breathe normally.

#

3. HEAT CASUALTIES

Most Marines are familiar with the effects of strenuous physical activity under conditions of high temperature and humidity. Three kinds of heat injuries can result in areas where these conditions are present; Cramps, exhaustion (prostration) and heatstroke (sunstroke).

Several factors influence the susceptibility of individuals to heat injury. The person who is overweight is particularly susceptible. The length of exposure and the degree of physical activity play important parts. Acclimatization time varies with each individual, but about 2 weeks is the accepted period to become adequately acclimatized.

Summarized below are the principal symptoms, preventive measures, and treatment for heat injuries.

	<u>CRAMPS</u>	<u>EXHAUSTION</u>	<u>STROKE</u>
Patient notices	Mild to severe pain.	Exhaustion, faintness.	Feeling of extreme heat, weakness, no sweating, confusion, possible unconsciousness.
Others notice	1. Spasms, rigidity of muscles. 2. Normal temperature.	1. Profuse sweating. 2. Normal or slightly elevated temperature. 3. Unconsciousness on rare occasions.	1. Hot, dry skin. 2. Elevated temp. (102-112°). 3. Flushed skin; strong, rapid pulse. If skin becomes pale and with weak pulse, critical condition exists. 4. Possible unconsciousness and convulsions.
Prevented by	1. Salt or salt tablets added to water.	1. Less exertion on hot days. 2. Use of shade, salt and water.	1. Avoiding over-exertion on hot days. 2. Use of shade, salt and water.
Treatment	1. Give salted water and/or salt tablets. 2. Massage muscles.	1. Rest on back in shade. 2. Loosen clothing. 3. Cool water compresses to face. 4. Salt tablets.	1. Ideally, submerge patient in cool water to lower body temp.; when temp. is normal (check every 10 min.) start saline solution by vein, or 2. Flap alcohol moistened sheets over naked body.

#

4. PERSONAL CLEANLINESS TIPS

Marines in the field can keep healthy only by observing the basic rules of personal hygiene. Although it is sometimes difficult to maintain personal cleanliness, observance of the following health

rules will help to prevent illness and maintain a high state of readiness:



- If possible, bathe your entire body at least once a week with soap and water. When bath or shower facilities are not available, take a sponge bath, using your helmet.
- Underclothing absorbs perspiration and oil from the body, causing a loss of insulating quality. Change underclothing frequently.
- Do not use ointments, salves or medicines on your feet unless prescribed by a medical officer.
- Change socks and use foot powder daily, whenever possible. Always carry extra, clean socks.

→ Brush your teeth at least once a day. Brush with salt from rations or with water alone, if no cleaner is available.

→ Keep hair and nails clipped short.

#

5. MALARIA CONTROL

When a unit experiences frequent enemy contact, provisions of the malaria control program tend to receive less emphasis. The danger of malaria is additionally increased during these periods by the proximity of significant numbers of VC/NVA personnel who suffer a high rate of malaria infection. This is especially true when units must operate for several days in areas of recently abandoned enemy base camps. Malaria control measures must receive greater emphasis during periods of frequent enemy contact and when operating in areas of recently occupied enemy base camps.

#

6. SUPERFICIAL WOUNDS

Superficial cuts and wounds are being neglected, especially those associated with bamboo. Wounds of this type often lead to boils and skin infections which require treatment with antibiotics. Personnel must be made aware of the seriousness involved in neglecting these types of wounds and of the necessity for immediate first aid.

#



7. EXTRA BATTLE DRESSINGS

Many FMF hospital corpsman are using discarded ammunition bandoleers to carry extra battle dressings. Two bandoleers worn cross-chest can hold twenty-eight dressings without taking up extra pack/cartridge belt space. The weight is evenly distributed and there appears to be no significant problem from heat or discomfort.

#

8. MEDICAL TIP

High humidity and warm temperatures sometimes cause problems for the corpsman who carries medicines in capsule form. The environment

will cause the capsules to melt and stick together. A few aspirins ground into a powder and placed in the capsule container will keep the capsules dry and separated.

#

9. AMBULANCE READINESS TIPS

- Ensure that special patient handling equipment is installed and operational.
- Use a checkoff list to ensure proper medical supplies are carried in the ambulance.
- All corpsmen should be proficient in rigging and loading ambulances.
- Assign one person specific responsibility for the condition of an ambulance.



→ Emergencies require instant response - the ambulance and crew must be ready at all times.

#

10. MEDEVAC PROCEDURES

The use of the helicopter for rapid transportation of casualties to medical facilities has decreased the mortality rate of personnel wounded in action. Because of this, there is a strong tendency to request helicopters for casualty evacuation without giving proper consideration to other appropriate transportation available, such as ambulances. Often, helicopter transportation is furnished for wounds of minor nature. This denies their use for tactical employment, which could be detrimental to the overall success of an operation. In addition, during helicopter evacuation of casualties, supporting arms fire is normally curtailed to ensure the safety of the helicopter from friendly fire. During this period, hostile forces have more freedom of movement and hostile fire can be concentrated against the evacuation helicopter. Occasionally, battalion medical personnel are being bypassed and decisions as to the urgency of the evacuation are being made without the benefit of competent medical advice. Requests for evacuation of patients by helicopter will normally be passed to the direct air support center (DASC) by radio or telephone. The originator will classify each request as either ROUTINE, PRIORITY, or EMERGENCY.

Definition of the medevac mission classifications are as follows:



- Routine: Evacuation of deceased personnel; evacuation of a patient with a minor injury or illness; or the routine transfer of a patient from one medical facility to another for further treatment.

- Priority: Evacuation of seriously wounded, injured, or ill personnel who require early hospitalization, but whose immediate hospitalization is not a matter of life or death.

- Emergency: Evacuation of critically wounded, injured, or ill personnel whose immediate evacuation is a matter of life or death.

This classification is justified when a case falls into one of the following categories:

- The casualty is unconscious from a head wound.
- The casualty is actively bleeding.
- The casualty is in severe shock.
- The casualty has suffered the loss of an arm or a leg, has an abdominal wound, or has a penetrating chest wound.

Before requesting helicopter evacuation, the commander on the scene should give consideration to the following:

- Security of the landing site and freedom from interdicting hostile fire.
- If the landing site is not secure, movement of patient to a secure area should be attempted.
- If movement of the casualty is impossible, every effort must be made to utilize suppressive fire by small arms, artillery, aircraft, or a combination of these means, while the evacuation is in progress and until the medevac helicopter clears the area.
- Communication between the commander on the scene and the medevac helicopter is essential

to exchange information concerning the landing approach, pickup point, and terrain characteristics.

#

11. POSITIONING OF MEDEVAC HELICOPTERS IN AN UNSECURED ZONE

The tactical situation on the ground is influential in the positioning of the medevac helicopter in an unsecured landing zone. It is extremely important that the helicopter pilot know the location and direction from which a supported unit is receiving hostile fire before he commences his approach to the zone. This will enable the pilot to approach and land by the most secure route and position the helicopter so as to limit exposure to hostile fire.



Positioning the tail of the medevac helicopter toward the last known direction of fire offers less target exposure than if the side or front of the helicopter is facing the direction of fire.

#

12. PATROL MEDEVAC PLANNING

When patrols are operating in dense jungle the problem of casualty evacuation may assume major proportions. Before leaving the base camps the patrol leader should mark locations of possible landing zones on his map. Should a casualty occur he is then in a position to decide whether to move to an existing clearing or search for and cut an emergency landing zone. An additional tip: cutting equipment, if available, should be carried by every patrol operating in jungle terrain. The patrol leader must ensure that the selected landing zone is clear of mines and boobytraps.

#

13. ROBERTSON LITTER

Extensive testing carried out in late 1967 by elements of 1st MAW in SVN proved the capabilities of a new litter for air medical evacuation. The test involved evaluation of the Robertson semirigid, poleless litter for use in medical evacuation involving hoisting casualties into hovering aircraft.



The Robertson litter has actually been in use by the Navy for many years and was originally designed to hoist injured personnel up through hatches from below-deck spaces aboard ship. The standard Robertson litter was modified by 1st MAW by installing V-rings at either end to facilitate loading and hoisting patients aboard helicopters. A simulated human body, made of leather, filled with sand

and weighing 250 pounds, was used in the initial tests.

The tests indicated that several advantages accrued to the Robertson litter in comparison with the Stokes litter for evacuating casualties. The light weight (15 pounds) and ease of transportation gained by packaging the litter in a compact tube; the design which furnishes back support and rigid support for neck, leg, and hip injuries; the large canvas chest plates and the strap system which offers ideal methods of applying pressure to wounds; and the fact that casualties are lifted vertically rather than horizontally, thus decreasing the possibility of engagement with heavy canopy, are all positive advantages of the Robertson litter.

#

14. DENTAL TREATMENT

Personnel being deployed to the Republic of Vietnam should ensure that all necessary dental treatment is completed prior to deployment. BUMEDINST 6600.3A directs dental facilities to implement, on a priority basis, a program whereby Navy and Marine Corps personnel will receive maximum dental treatment prior to departure for RVN. Incountry unit commanders should ensure that personnel are aware of the location of supporting dental units. At the present time, three dental companies are supporting Marine and Navy forces in I CTZ.

#

15. DENTAL FIELD UNITS

The Encore is a portable high-speed dental unit that brings modern dentistry to Marines in the field. Daily maintenance of this unit is an important and never-ending responsibility of all dental personnel. Malfunctioning of the Encore unit is frequently related to the lack of proper maintenance procedures by the users. The following basic tips will obviate many of the user's complaints:

- Purge all lines and air compressors of moisture, prior to use, daily.
- Drain emptying valve on the console after each use.
- Remove burs with the bur ejector. Insert burs with finger pressure, then insert further with the bur ejector.
- Flush the vacuum system and turn it off daily.
- Clean inside vacuum tank with soapy water on a daily basis, twice daily for surgery.
- After cleaning, the vacuum should be flushed with a diluted solution of WESCADYNE to reduce the growth of bacteria.
- Drain compressed air tank, while under pressure, to completely purge moisture from the tank.

→ Clean and oil straight handpiece and its con-
trangle.

→ Clean the air filter on the compressor every
4 days. Use soap and water or cleaning fluid, let
the filter dry overnight.

→ Remove the compressor and air tank from
its container and clean all surfaces once a week.

